

New Zealand Forest Road Engineering Manual

NZ Forest Owners Association
Level 9 / 93 The Terrace / Wellington
www.nzfoa.org.nz



New Zealand Forest Road Engineering Manual

© Copyright 2011

All enquiries regarding copyright should be directed to the publishers, The New Zealand Forest Owners Association Incorporated (FOA).

The objective of this Manual is to ensure roads, water crossings and related infrastructure in New Zealand plantation forests are fit for purpose and meet high environmental standards.

The Manual may be copied or downloaded from the FOA website by those who own, manage or work in New Zealand plantation forests, and their advisers.

The Manual may not be republished for sale, or used for promotional or other commercial purposes, without the permission of the publisher and the copyright owner.

NZ Forest Owners Association (Inc)
ForestWood Centre
Level 9, 93 The Terrace, Wellington
PO Box 10986, The Terrace
Wellington 6143
New Zealand

Tel + 64 4 473 4769
Email: admin@nzfoa.org.nz

ISBN 978-0-473-19454-3 PRINTED
ISBN 978-0-473-19455-0 PDF

February 2012, updated February 2020

Acknowledgements

The FOA thanks all those involved in the revision and publication of the NZ Forest Road Engineering Manual, including:

Brett Gilmore (Project Leader), Glen Mackie and Kelvin Meredith (2012), as well as acknowledging contributions and reviews by Rien Visser, Kristopher Brown and Simon Fairbrother, School of Forestry, University of Canterbury, and Peter Weir, Ernslaw One Limited.



New Zealand Forest Road Engineering Manual

The *New Zealand Forest Road Engineering Manual* is published by the NZ Forest Owners Association and is supported by the Forest Growers Levy Trust and the NZ Farm Forestry Association







Contents

PREFACE	5
SCOPE, PURPOSE, USE	6
CHAPTERS	
1. Terminology, economic analysis, understanding risk	9
1.1 Terminology	10
1.2 Economic analysis	10
1.3 Understanding risk	12
2. Regulations, consents and approvals	15
2.1 National Environmental Standards for Plantation Forestry (NES-PF)	16
2.2 Heritage New Zealand Pouhere Taonga	21
2.3 The Health and Safety at Work Act	22
2.4 NZ Transport Agency approval for access onto state highways	22
2.5 District council approval for access onto council roads	24
3. Planning for roads	25
3.1 Road classes	26
3.2 Arterial roads	27
3.3 Secondary roads	27
3.4 Spur roads	28
3.5 Establishment tracks	28
3.6 Spatial information	29
3.7 Initial field work	31
3.8 Manual design method: Stepping out a roadline on a topo	31
3.9 Running a grade line in the field	34
3.10 Full road design	35
3.11 Working with road survey data	36
3.12 Geometric road design	37
3.13 Curve widening	43
3.14 Horizontal alignment	44
3.15 Vertical alignment	45
3.16 Calculating the safe stopping distance	49
3.17 Setting out the roadline	49
4. Planning for landings	51
4.1 Common landing layouts	52
4.2 Landing planning considerations	55
5. Road and landing construction	59
5.1 Soil and rock properties	60
5.2 Managing adverse environmental effects	63
5.3 Marking clearing widths	64
5.4 Roadline salvage	68
5.5 Daylighting	69
5.6 Road formation	70
5.7 Drainage control during earthwork construction	78
5.8 Earthwork machinery	78
5.9 Estimating machinery production	80
5.10 Stabilising cut and fill slopes during construction	83

Continued over

NZ Forest Road Engineering Manual

Contents – continued

6.	Pavement design, subgrade preparation and pavement construction	91
6.1	Traffic loading	94
6.2	Evaluating subgrade properties	97
6.3	Determining pavement depth	100
6.4	Pavement material properties	102
6.5	Compaction of subgrade and pavement	105
6.6	Compaction equipment	107
6.7	Pavement construction	112
6.8	Weak subgrades	115
6.9	Chemical stabilisation of pavement or subgrade	118
7.	Erosion, sediment and slash control structures	123
7.1	Ditches	124
7.2	Cut-outs	128
7.3	Berms	128
7.4	Drainage culverts	130
7.5	Flumes	133
7.6	Sediment traps and soak holes	135
7.7	Silt fences	137
7.8	Sediment retention ponds	139
7.9	Debris traps	140
8.	River crossings	143
8.1	Fish passage	144
8.2	Selecting the location and crossing type	146
8.3	Fords	148
8.4	Temporary river crossings	150
8.5	Single culvert river crossings	153
8.6	Battery culvert river crossings	160
8.7	Drift deck river crossings	163
8.8	Single span bridge river crossings	165
8.9	Prediction of flood flows, and sizing culverts	169
9.	Infrastructure repairs and maintenance	179
9.1	Maintenance programme	180
9.2	Economic evaluation of road maintenance projects	181
9.3	Managing maintenance requirements	182
9.4	Commonly used maintenance machinery	183
9.5	Road surface maintenance	184
9.6	Road foundation maintenance	187
9.7	Landing rehabilitation and decommissioning	189
9.8	Roadside vegetation maintenance	190
9.9	Erosion and sediment control structure maintenance	191
9.10	River crossing maintenance	195
9.11	Debris trap maintenance	199
APPENDICES		
	Forest road engineering terminology	200
	References	206
	Websites, resources, databases	208



Preface



Peter Weir

The NZ Forest Owners Association (FOA) is strongly committed to assisting its members to achieve the highest standards of plantation forestry practice. This commitment is underpinned by the provision of quality publications such as the *New Zealand Forest Road Engineering Manual*. First published in 1999 by the former Logging Industry Research Association (LIRA), it was later revised in 2012. This 2020 edition is a substantial review of that revision.

The Manual is a well-used reference for forest roading supervisors, harvest planners, forest roading engineers, and forest managers and owners. However, an industry survey in 2018 identified that some of the content needed to be updated and improved.

In this 2020 edition, the Manual introduces new materials and methods, and updated construction techniques. Three chapters have been rewritten: Consents and Approvals (Chapter 2), Erosion, Sediment and Slash Control Structures (Chapter 7) and River Crossings (Chapter 8). Planning for landings (Chapter 4) is a new chapter, and complements the revised Planning for Roads (Chapter 3).

Much of the substantive change is due to the National Environmental Standards for Plantation Forestry (NES-PF) becoming law in 2018. It provides a nationally consistent set of regulations to manage the environmental effects of plantation forestry activities, and creates rules around many of the forest engineering activities in this Manual.

The FOA encourages those who use this Manual to do so in conjunction with other FOA publications. These include the companion *NZ Forest Road Engineering Manual Operators Guide*, and the recently released suite of *FOA Forest Practice Guides*. In doing so, roading infrastructure will be fit for purpose and meet the industry's high environmental standards.

The FOA thanks all those involved in the revision and update of this Manual.

Peter Weir
President
NZ Forest Owners Association

The *New Zealand Forest Road Engineering Manual* is published by the NZ Forest Owners Association and is supported by the Forest Growers Levy Trust and the NZ Farm Forestry Association



Scope, purpose and use

Introduction

The *New Zealand Forest Road Engineering Manual* covers all aspects of planning, design, construction and maintenance of unsealed forest roads. It is a detailed guide for those who have a limited engineering background, as well as a reference for more experienced forest roading supervisors and engineers. The best road construction results will be achieved by the application of technical information combined with knowledge and experience. Manual users are encouraged to seek out and draw upon the knowledge of experienced roading contractors, supervisors and engineers in the forest industry.

Building and maintaining forest infrastructure is a critical part of a successful and sustainable forest industry. In New Zealand's plantation forest estate there is an estimated 25,000 km of existing forest roads and over 100,000 landings. As our commercial plantation forest continues its growth phase due to the extensive new plantings in the early 1990s, approximately 1500 km of new forest roads are being built each year.

While building and maintaining forest infrastructure results in an economic benefit by providing access for harvesting, it reduces the forested area by 4 per cent. Careful planning is critical in terms of managing road expense and maintaining environmental and safety standards. A road that meets environmental, safety and economic goals can be referred to as being 'fit for purpose'.

This Manual is only one tool in a suite that has

been developed to assist with planning and operational decision-making. It should be read in conjunction with other key references and planning documents. These include WorkSafe's *Approved Code of Practice for Safety and Health in Forest Operations*, which provides detailed information on safe practice.

Planning for roads and landings is normally done as part of the broader harvest planning process. This is because the aim of forestry infrastructure is ultimately to provide suitable access at the appropriate service level for forestry operations.

A good planner has a broad skill set, uses a suite of available tools to assist decision-making, and preferably has a detailed knowledge of the area in which they are working.

A recent survey of forest road managers noted the challenge of building roads well in advance of harvesting – the ahead position – as is recommended best practice. Other challenges include putting together and managing an effective road lining crew that is efficient in harvesting and road building, keeping costs down, managing fair payment systems and dealing with cleanup operations after major storm events.

Roads and landings need to be appropriately located and built for the terrain they are crossing. Unless the forest is on easy country with few safety, environmental or social constraints, the task is often more complex than simply determining the location, width and alignment that gives the lowest combined cost for road construction, maintenance and haulage. By far the most cost-effective stability mitigation on logging roads is done at the planning stage – long before any machine reaches the road location.



Well-designed and built roads are safe, have a low environmental impact and are an asset to the forest landowner.



Planning and field reconnaissance identify and mitigate potential construction and environmental issues, and a well-prepared paper plan ensures that field validation focuses on addressing issues rather than trying to identify them. It is a false economy to take shortcuts in these areas. Economic analysis may be a useful tool to assist in determining the viability of a construction programme. See 1.2 Economic analysis (Chapter 1).

Construction of forest roads and landings can produce significant environmental impacts. Planners need to ensure that laws, such as the Resource Management Act (RMA), regulations such as the National Environmental Standards for Plantation Forestry (NES-PF), and environmental rules and guidelines, such as those set by the NZ Forest Owners Association (FOA) are followed to minimise adverse effects.

Other FOA guides include the companion *NZ Forest Road Engineering Manual Operators Guide*, and the recently released suite of FOA *Forest Practice Guides*.

Road planning is often a trade-off between competing requirements. A common primary purpose of a new forest road is to link a proposed landing to the existing road network, because its position is critical in ensuring an efficient harvesting operation. However, it is not always possible to get a road to these locations. For example, there may be safety, environmental or economic constraints that restrict the selection of that option. The outcome is a trade-off where the landing position is changed, or an alternative harvesting system is used, for example, two-staging.

A key part of road planning includes the road specification, also commonly referred to as a road standard. Road standards depend primarily on the expected level of use, and have a required width, maximum grade, curve radius and other factors to ensure they are fit for purpose.

However, most forest roads will also need to transport non-standard vehicles such as haulers, transporters, off-highway logging trucks, stem trucks or trucks with increased weight and dimension, and will require special

High quality mapping is a good investment

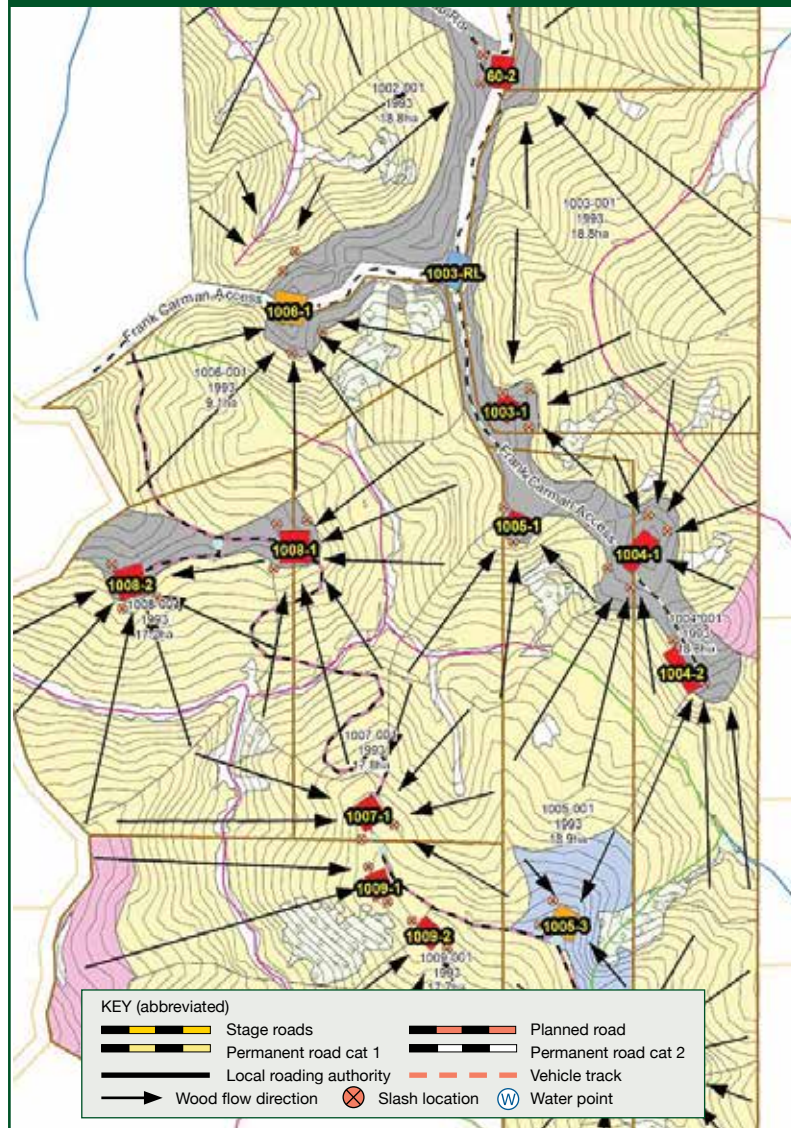

road geometry and pavement design to accommodate them. These vehicles often require greater road width, especially on curves to address off-tracking, and greater pavement depths to carry higher axle loads. Also, over the last five years high productivity motor vehicles (HPMV) have become increasingly used as more highways have been opened for use by these vehicles. Many logging trucks are 50 Max, which is a class of HPMV. The vehicle combinations have one more axle than conventional 44-tonne vehicles, so the overall truck load is spread over more wheels.

Scope, purpose and use – continued

Navigating around the Manual

The Manual's goal is to provide a detailed overview of the forest engineering process – from planning, field layout and construction to maintaining the asset. It is not a linear process because building even a small forest road may have challenges. As already mentioned, infrastructure design and build are complex and typically require many elements to be considered that may differ from site to site. The Manual also provides a brief summary of relevant regulations and other statutory requirements.

Chapter 1 introduces forest road engineering terminology and two elements critical to effective infrastructure design and build – economic analysis and risk management.

Chapter 2 covers consents and compliance. For all earthwork projects it is critical to be aware of legal requirements – planning, construction and maintenance must comply with them. Depending on the site and scale of the project, operations may require permission (a 'consent'). This chapter provides an overview of the relevant legislation or regulations, describes where this information can be found and highlights the typical processes to follow.

Chapter 3 provides a step-by-step approach to designing the forest road. This includes determining the type of map resources available, preparing a paper plan and undertaking field investigations, through to laying out a fully designed road in a forest.

Chapter 4 provides an overview of landing design. While most of the Manual focusses on forest roads, landings are an integral part of forest infrastructure. This chapter does not discuss broader planning construction processes that are the same as for roads.

Chapter 5 describes road and landing construction from a planning and operational perspective. It provides information on both technique and equipment options.

Chapter 6 is about the road pavement. It covers the testing of the subgrade (parent material) on which the road will be built, calculating traffic loading, designing pavement thickness, and options for stabilising a weak subgrade.

Chapter 7 discusses erosion, sediment and slash control structures. It is essential that water is dispersed and at times treated. These are regulatory requirements. This chapter describes ways to reduce environmental impact and maintain the integrity and longevity of the infrastructure through erosion and sediment control.

Chapter 8 provides different options for getting across rivers, the importance of maintaining fish passage, and includes technical information on some of the structures. For example, how to calculate culvert dimensions.

Chapter 9 highlights the importance of maintenance, not just to ensure the roads stay open for the intended truck traffic, but also the importance of protecting the infrastructure investment.



Chapter 1

Terminology, economic analysis, risk management



1. Terminology, economic analysis, risk management

1.1 Terminology

A wide range of terms are used in forest road engineering. At times, more than one term is used for the same thing. Engineers, earthworks coordinators and contractors can talk at cross-purposes because definitions may not be consistent. For example, is a ditch a water table or a side drain, or are they all the same thing? Are culverts used to drain water tables, drains or ditches or are these used to cross rivers? Is a river a stream or a waterway or are these the same thing too?

It may seem rather academic, but operationally, if you are not talking the same language challenges will arise. The regulations set out in the *National Environmental Standards for Plantation Forestry (NES-PF)* provide very specific definitions. For example, a forestry track versus a forestry road.

A number of illustrations are used throughout this Manual to help clarify the terminology, such as the one below for a typical forest road cross section. To support a better understanding of terminology, a comprehensive compendium of terms has been included in the Appendices.

1.2 Economic analysis

Ensuring that forest roads are safe and have a low environmental impact is paramount to the concept of fit for purpose roads. However, infrastructure construction is both expensive and resource intensive. As such, carrying out an economic evaluation is important to assess the viability of the construction programme. It answers the financial implications of the what, when, where, why and how questions. As part of a robust environmental and economic analysis process, alternative construction scenarios should be compared to help decide the best use of resources.

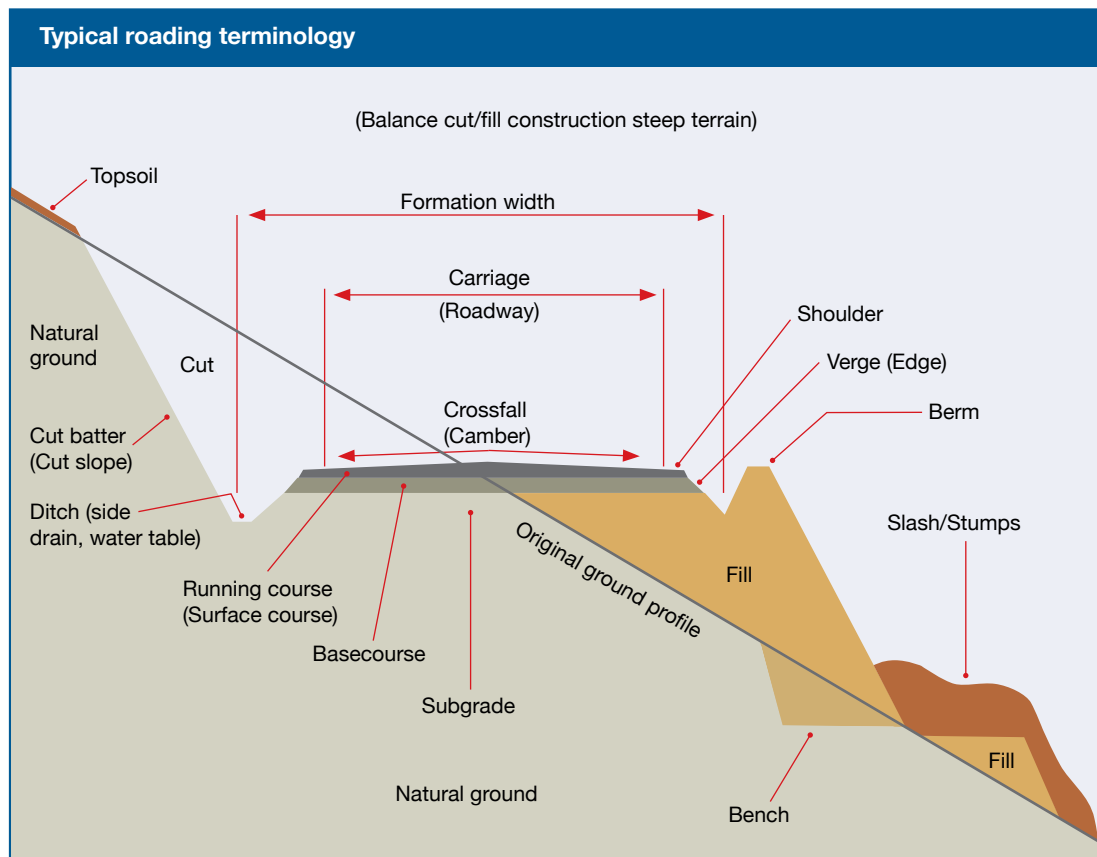



Comprehensive economic analysis of a planned road option on anything other than the easiest of country is more complex than simply combining costs associated with road construction, maintenance and haulage. In reality, the situation is often more complicated and includes the need to evaluate and incorporate safety and environmental risk.

Road location and construction techniques need to be justifiable in a much broader sense than the lowest combined cost. If

forest roads or landings are found to be non-compliant, then fines, legal fees, business interruption and mitigation costs can add up to hundreds of thousands of dollars. Consider a broad view of costs – actual and opportunity costs – when determining the optimum infrastructure standard.

Technical evaluation of anticipated road usage and function is a core part of determining appropriate road and construction standards, in terms of geometrics and pavement materials. For example, low wood flow volumes would typically require a lower road geometry and pavement standard than a high-volume road.

Economic evaluations are not straightforward. They often require specialist skills such as those of a management accountant, engineer, and environmental and cartage representatives. A common approach includes using the principles of Discounted Cash Flow analysis (DCF). Discounting considers the effects of interest and inflation, and compensates for costs or benefits that arise in the near future rather than on those that arise at a later date. For example, initial construction costs require no adjustment since these are costs at time zero. However, maintenance costs in the future need to be adjusted to calculate an estimate of their present worth or present value (PV). This takes into account the changing value of money over time

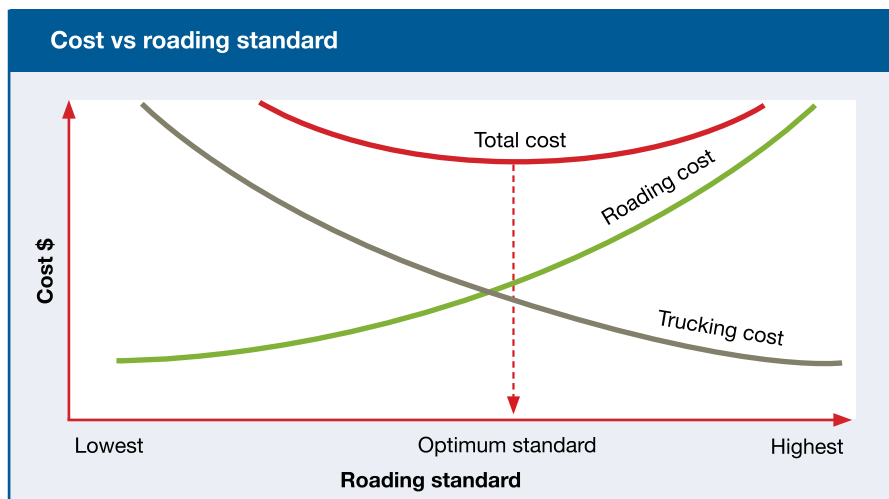

Cost vs road standard. Note that the optimum road standard is a compromise between minimising road construction cost, through-life maintenance cost and trucking cost

due to interest rates and inflation.

DCF is useful because it evaluates a project back into present day values, but it has strengths and weaknesses. DCF is very sensitive to changes in discount rates and costs and this may lead to poor decisions, especially if costs between scenarios are spread over different time horizons. As such, sensitivity analysis should be part of the appraisal. Also, DCF may not fully factor in environmental or social risk because they are hard to account for in dollar terms. For example, a high erosion risk site, where road failure could lead to substantial off-site impacts, may result in a large mitigation cost.

The following are factors that should be considered when undertaking an economic analysis:

- Decide on the design period for the analysis. The structural design period is the time during which the pavement will perform to a certain standard or serviceability without major repairs
- Calculate the initial capital cost. This includes the cost of in-place materials in a pavement structure, and the equipment and labour necessary to prepare, place and finish the pavement structure
- Choose an appropriate discount rate. This is a critical requirement as it heavily

1. Terminology, economic analysis, risk management – continued

impacts the time value of money. Determine the rehabilitation costs when the road quality reaches the limits of acceptability. Rehabilitation costs are dependent on accurate predictions of the time it takes a pavement structure to reach terminal serviceability after an initial construction

- Identify the salvage return or residual value of a pavement at the end of the analysis period. Computation of this cost allows for comparison of designs with different serviceability at the end of the analysis period
- Estimate traffic delay costs. Maintenance operations disrupt traffic flow and cause vehicle speed fluctuations, stops and starts, and time losses. The user cost incurred is often a significant portion of the total cost and should be included in the economic analysis
- Determine user costs or how the pavement design affects the user. User costs are related to the serviceability and deterioration history of the pavement. For example, vehicle operating costs such as fuel use, vehicle maintenance, travel time, accident and discomfort costs
- Identify community and environmental costs. These costs can be significant especially where risks are high. The formulae associated with economic analysis is not covered in this Manual. There are numerous specialist books on the subject.

1.3 Understanding risk

Risk management needs to be considered in all infrastructure projects. While laws and regulations must be met, it is essential to maintain our social licence to operate by being aware of the proximity of neighbours and the broader community. Even on the easiest sites, health and safety and the environment should be top priorities in earthworks management.

Risk is comprised of two components – the probability of something happening and the consequence if it does. This Manual provides engineering options to reduce both components. For example, Erosion, Sediment and Slash Control Structures (Chapter 7) gives solutions

to many common forestry risks by reducing the chance of an environmental incident and the seriousness of the outcome if it did occur.

There are factors both within and outside our control. Environmental aspects that planners and forest engineers have direct control over include:

- The location of the infrastructure
- Construction design standards, including erosion and sediment control structures
- The management of earthworks construction. For example, where fill is placed, and whether earthworks meet specifications and are constructed in suitable weather conditions.

Risk must also be considered in the planning, design and construction of site factors that are outside our control. These include:

- Topography
- Soil, geology, and overall erosion susceptibility
- Climate and storm occurrence and intensity
- Protected areas such as indigenous vegetation areas, threatened species and fish habitat, historic and archaeological sites
- Sensitivity of the downstream receiving environment
- Phone lines, water pipes and other services.

1.3.1 Land ownership, boundaries and access

Unfortunately, sometimes harvesting, and occasionally roading, occur on a neighbouring property without knowledge or consent. Title boundaries do not always follow sensible operational boundaries so neighbours often have informal agreements. Always do a cadastral (map or survey) check in order to establish the land title and obtain an oversight on land ownership, boundaries and access. Do not just take the supposed landowner's word that they own the land and/or trees. Access determined on a handshake a decade ago between neighbours can lead to major problems if not sorted out at the initial planning stage. Also, it is always good to let the tenant know of plans in advance if there is an absentee landowner.

Egress onto council and state highways



Always determine land and tree ownership through legal checks, before work starts.

needs to be well thought out and, where possible, should be discussed with the relevant organisation well in advance of harvest. Regulations, consents and approvals (Chapter 2) discusses in detail access onto public roads and the process to get approvals.

1.3.2 Understand site features

The following paragraphs provide some information on site features that should be considered when planning for infrastructure. It is not an exhaustive list. In some areas different factors will be significant and others irrelevant. Create checklists of factors that need to be considered in your working circle.

Site topography will influence the location/ position of road and landing infrastructure, and the earthworks construction techniques employed. Obtaining suitably detailed mapping and survey data is an essential step in the

planning and design process. 1:5,000 scale topographical maps with 5 m contour are often used for planning, however more detailed topographical and engineering surveys may be necessary for the design of large scale and high-risk earthworks.

Site geology and the stability of steep slopes should be assessed during the planning phase. Avoid, as far as practicable, locating infrastructure on high risk areas like gully heads, landslide scarps or slips, earthflows or near riparian margins. Terrain models produced from LiDAR survey and photography are particularly useful in identifying hazardous landforms and features such as hummocky surfaces and crescent shaped depressions.

Field inspections will identify other signs, such as trees leaning uphill or downhill, wetlands or wet ground in elevated positions, plants such as rushes or nikau palms growing on a

1. Terminology, economic analysis, risk management – continued

slope, and water seeping from the ground. Soil classification and understanding the slope stability is an important factor in the design of earthworks. The *Field Description for Soil and Rock – Guideline for the Field Classification and Description of Soil and Rock for Engineering Purposes* is a good reference document.

Water bodies and drainage are critical elements in road and landing construction. Avoid sediment discharge to water bodies to protect aquatic ecosystems. The design process must consider the impact that the construction and ongoing use will have on water bodies. The natural drainage patterns should be identified with roads located and designed to cater for sensitive areas.

The NES-PF requires assessment of many environmental considerations but not all. For example, in many parts of New Zealand, new archaeological sites are still being regularly identified in forestry operations. Understand your obligations under Heritage New Zealand. This is discussed in Chapter 2.

Powerlines can be challenging to work with. Be careful of the distance requirements for machinery around some of the larger capacity cables like the 22 KV and larger KV lines. Work with the relevant lines company. Accidently damaging lines can have financial and social impacts to you and users.

1.3.3 Set design standards and carefully manage earthworks

These critical road components will be discussed in detail throughout the Manual. The first step in the design process is to confirm operating requirements and the design standards. Appropriate design standards will ensure fit for purpose infrastructure that is safe and efficient for road users and the harvesting operation, and which minimises the foot print (scale and extent) and environmental impact of the earthworks.

The design process should include a constructability review. This considers the timing and sequencing of work, roadline salvage operations, the safe placement or disposal of stumps and stripping, the disposal of unsuitable material and that cut to waste in end-haul earthworks. The review should be a risk assessment.

Successful and effective earthworks projects include good production planning. The contractor needs to understand the designer's intention for the earthworks in order to plan and implement the earthworks successfully. This requires the designer to provide clear project specifications regarding the material and standard of workmanship required.



Chapter 2

Regulations, consents and approvals



2. Regulations, consents and approvals

Understanding the relevant legal requirements before embarking on forest road engineering activities is critical. Consents and approvals are often required. This chapter covers some of the main regulations that need to be considered. These include:

- The *National Environmental Standards for Plantation Forestry* (NES-PF) – for forestry activities, including earthworks, quarrying and river crossings
- The Heritage NZ Pouhere Taonga Act – for activities that could disturb or modify archaeological sites
- The Health and Safety at Work Act (2015) and related regulations, and the *Approved Code of Practice for Safety and Health in Forest Operations* (ACOP) – to undertake any forest activity
- District Council Road Controlling Authority and NZ Transport Agency requirements – for access onto council roads and state highways.

2.1 National Environmental Standards for Plantation Forestry (NES-PF)

The Resource Management Act 1991 (RMA) is the main piece of legislation that sets out how the environment is to be managed. The *National Environmental Standards for Plantation Forestry* (NES-PF) are the regulations made under this legislation.

The NES-PF came into force on 1 May 2018, and applies to any forest of at least one hectare that has been planted specifically for commercial purposes and is to be harvested. The NES-PF supersedes almost all district council plan provisions, and many of those of regional council plans, except in specific situations where the NES-PF allows councils to apply more stringent rules.

The intent of the regulations is to better protect the environment and to apply consistent environmental standards across the country while improving the productivity of the forestry sector and reducing operational costs. Councils previously managed the environmental effects of forestry activities through regional and district plans.

The NES-PF regulations will be reviewed and

updated so always ensure you are using the most up-to-date version. A copy of the NES-PF can be downloaded from the NZ Legislation website (www.legislation.govt.nz). You could also subscribe to Te Uru Rākau's (Forestry New Zealand) NES-PF update service. Their website has a lot of useful information on the NES-PF.

An essential requirement is a copy of the regulations and its accompanying comprehensive user guide. This is a useful tool to help interpret the rules. For these and other NES-PF documents refer to www.teururakau.govt.nz/growing-and-harvesting/forestry/national-environmental-standards-for-plantation-forestry/.

This Manual provides only a brief overview of the regulations and some of the key operational considerations you should be aware of. For specific detail it is important to read the regulations in full.

2.1.1 Forestry activities and the NES-PF

There are separate sets of regulations for eight core forestry activities:

- Afforestation (planting new forest)
- Pruning and thinning to waste
- Earthworks
- River crossings
- Forestry quarrying (extraction of rock, sand, or gravel within a plantation forest or for operation of a forest on adjacent land)
- Harvesting
- Mechanical land preparation
- Replanting.

In addition to the activity specific rules, there are separate regulations for ancillary activities (NES-PF Regulations 83 to 95) and general provisions (NES-PF Regulations 96 to 105) that need to be complied with. These cover activities such as debris traps, indigenous vegetation clearance, riverbed disturbance, sediment discharges, dust, noise and bird nesting etc that can often be of relevance to earthworks or harvesting activities.



For example, roading next to a river or through a patch of native bush.

2.1.2 Activities and risk

The status of activities under the NES-PF is underpinned by risk. For all activities it is important to identify risks and figure out how to respond to them. Two of the three primary drafting gates for risks in the NES-PF are covered below: Erosion Susceptibility Classification and the Fish Spawning Indicator. The third – Wilding Tree Risk – is not applicable to road engineering.

Erosion Susceptibility Classification

For some activities like afforestation, replanting and earthworks, the key risk thresholds are set by the erosion susceptibility classification (ESC), which is in turn based on land use capability (LUC) mapping. The criteria to determine LUC include the rock type, topography, climate and the dominant erosion process. The ESC assigns each of the existing LUC units into one of four erosion susceptibility classes:

- Low risk (green zone)
- Moderate risk (yellow zone)
- High risk (orange zone)
- Very high risk (red zone).

Most activities, including earthworks, are permitted in low and moderate risk areas and can be carried out without the need for consent, subject to complying with the permitted activity regulations. Activities in higher erosion risk areas will generally require resource consents.

The ESC-PF for any area of New Zealand can be accessed from the Te Uru Rākau website www.teururakau.govt.nz/growing-and-harvesting/forestry/national-environmental-standards-for-plantation-forestry/erosion-susceptibility-classification.

Fish Spawning Indicator

The NES-PF also controls the disturbance of riverbeds during the spawning season for a number of fish species. This process is underpinned by the fish spawning indicator tool which maps rivers that are either known to have,



Most activities, including earthworks, are permitted in low and moderate risk areas without the need for consent, if they comply with the permitted activity regulations.

2. Regulations, consents and approvals – continued

or have a high likelihood of containing, key fish species. The fish spawning indicator maps can be accessed from the Te Uru Rākau website link: www.teururakau.govt.nz/growing-and-harvesting/forestry/national-environmental-standards-for-plantation-forestry/fish-spawning-indicator/.

If you are undertaking earthworks that will disturb a riverbed, such as installing a river crossing, it is important that you check the fish spawning indicator tool to identify if fish are present in the river. If so, check the spawning times and associated rules (NES-PF Regulation 97).

2.1.3 Permitted activities and consents

Permitted activities can occur ‘as of right’ without the need to obtain a resource consent, provided they are undertaken in accordance with permitted activity regulations. Foresters are responsible for determining whether the activity is permitted before beginning work. A pragmatic and recommended step is to contact the council staff member responsible for forestry to clarify if a consent is required, and if they have any standard notification procedures in place. Industry peers are also a good source of information.

Under the NES-PF, some activities require giving notice to regional – and in some cases district – councils before commencement. Earthworks, river crossings and quarrying all have notification requirements. If you do not provide this information, the activity will not meet permitted activity status.

If the activity is not permitted, it requires a consent from the council or councils. Under the NES-PF they generally default to either a controlled or restricted discretionary category. Controlled activity consents will always be granted if they meet the specified matters over which the council can exercise its control. Applications can only be refused if they are not complete. Restricted discretionary consents give council the authority to decline the consent, or grant it subject to conditions, but only on matters to which the regulations have restricted its discretion.

If the forest owner or contractor believes that it will not always be possible to comply with the permitted activity regulations, they can ‘contract out’ of any given regulation by applying for a resource consent for that non-complying subset of the activity. For example, a discharge permit (a specific category of resource consent) might be sought for runoff in big storms if the roading contractor deems it unlikely or impossible to always comply with NES-PF Regulation 26 (sediment). This requires that there be no ‘conspicuous change in colour or visual clarity’ in receiving waters below the activity area.

The assessment of effects on the environment (AEE) in support of a discharge permit might be for runoff in a greater than one in 5 or one in 10-year storm event as it is unlikely that the council will grant a discharge permit for an annual storm.

2.1.4 Management plans

The NES-PF requires a management plan to be prepared for almost all forestry earthworks and quarry activities, and all harvesting. The NES-PF regulations require that some of these will need to be submitted to regional councils or unitary authorities, however councils may specify whether or not they wish to have the management plans submitted.

Management plans need to clearly identify any environmental risks and specify how the activity will be carried out in compliance with the regulations. Management plans are meant to strike the balance between certainty for councils around what needs to be included in the plan, with some operational flexibility for foresters on how this will be carried out. Management plan content is expected to be proportional to the complexity of the operation and risks of the site. The plan should strike a sensible balance between the amount of detail on risk and practice identification and the cost of plan preparation.

When preparing a management plan, it is essential to:

- Demonstrate site knowledge
- Have a process to identify risks
- Explain how risks will be managed.



The NES-PF requires management plans for almost all earthwork and quarrying activities.

Creating a management plan is not a ‘tick box’ or ‘cut and paste’ exercise. The specific matters that must be covered in a management plan are covered in Schedules 3 and 4 of the NES-PF. Forestry earthworks and harvesting plan requirements are in Schedule 3 and quarry, erosion and sediment are in Schedule 4. Forest managers must produce management plans.

2.1.5 Forest Practice Guides

A useful tool to assist with developing management plans are the Forest Practice Guides (FPGs). The FPGs were developed by Te Uru Rākau (Forestry New Zealand) and the FOA to describe forestry practices and include guidance on how to manage environmental risks. For example, earthworks have many FPGs including clearing and stripping, bulk earthworks, and placement and compaction. The FPGs are hosted on the NZ Forest Owners Association website <https://docs.nzfoa.org.nz/forest-practice-guides/>.

The FPGs can be referenced in management plans to detail the measures that will be undertaken to manage environmental risks. The FPGs are not compulsory to use, so you can use other tools such as forest company standards and guides.

The FPGs are written to provide enough detail so managers can construct plans to a good

standard, and for councils to assess whether the practice has been carried out correctly. Just like any other information written into a management plan, councils will expect to see these practices carried out on the ground. If it is intended that the company will only use parts of a particular FPG, it is important that this is made clear in the management plan.

2.1.6 Consent process

It is advisable to work with the relevant council from the beginning of the process, especially for large or complex projects that require consent. If the works require consent, it is important to start the consent process early, well before the project is due to start, to ensure delays to the project are avoided.

It is important that adequate information is provided with the consent application. If council requests further information on the consent application, it ‘stops the clock’ on the process until the information is provided. This can significantly lengthen the consent processing timeframe. Refer to your council, the Ministry for the Environment website www.mfe.govt.nz/rma/rma-processes-and-how-get-involved/where-get-advice-about-rma-applications-and-submissions or the quality planning website www.qualityplanning.org.nz/consenting/consenting-for-specific-details-on-the-consent-process.

2. Regulations, consents and approvals – continued

2.1.7 Recommended earthworks construction planning and design within the ESC

The erosion susceptibility classification (ESC) is one of the principle drafting gates to determine the status of an activity. As the risk classification increases, the rules around the activity strengthen. Consider using specialist advice if in-house skills are not adequate especially in orange zone > 25 degrees or in the red zone.

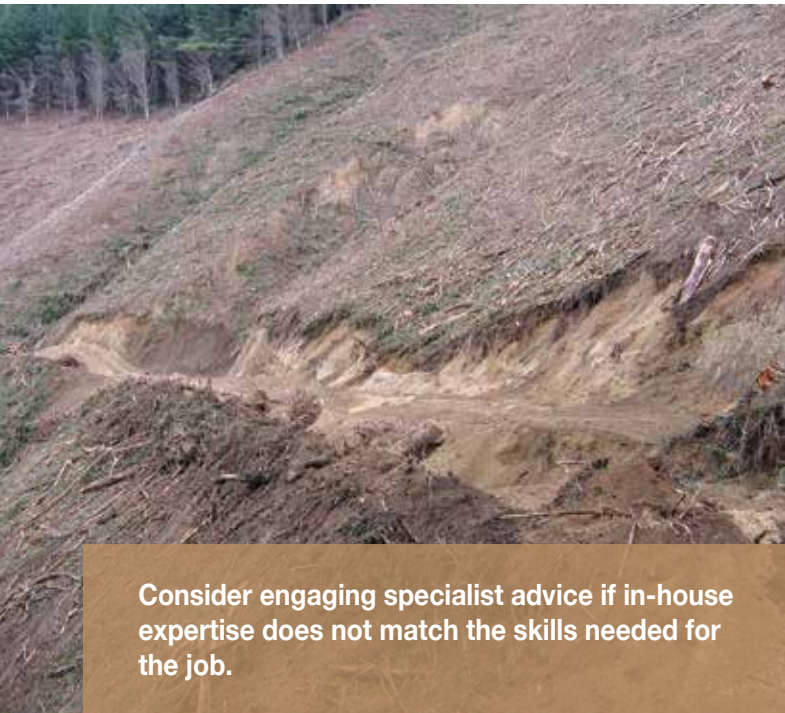

Consider engaging specialist advice if in-house expertise does not match the skills needed for the job.

The ESC classifications – green, yellow, orange and red

Green and yellow zone areas are generally characterised by well-developed soils and stable geology. Green zones are often flat and rolling contour, and yellow zones rolling to moderately incised terrain, though in some parts of the country they may encroach into steeper hill country. While steeper areas are typically geologically stable in a green or yellow zone, road and skid design still needs to be managed carefully. If good earthworks techniques are employed green and yellow zones should present a low erosion risk.

Orange zones are characterised by rolling steep

to incised terrain and shallow soils. Landslides are typically shallow. The soils become increasingly susceptible to slipping as the hill slope increases. Carrying out earthworks in an orange zone with slopes < 25 degrees, represents a moderate but manageable risk, if good earthworks construction techniques are implemented. Where the slopes are > 25 degrees, the erosion susceptibility is higher and there are limits on the scale of earthworks that are permitted in the NES-PF (refer to Regulation 24 (2) (c)). Resource consent (restricted discretionary) will be required where the permitted activity thresholds will be exceeded. Consent applications will typically need to be supported by engineering design appropriate for the level of risk.

Red zones are characterised by a combination of fragile, highly erodible soils and steep slopes. Carrying out earthworks in a red zone represents a significant risk and should be avoided, where possible. Resource consent (restricted discretionary) will be required. Consent applications will typically need to be supported by engineering design.

Consider engaging specialists in difficult terrain especially if in-house forest planner/engineer's skills or expertise do not match the anticipated technical and operational challenges.

Forest/geotechnical engineering and ESC

A forest planner/engineer needs to use a geotechnical design that is suitable for the site risk. This requires an understanding of both erosion risk and geotechnical engineering risk. Many situations will require experience-based judgements. In green and some yellow zones, a minimum basic understanding of local geology and soils may be adequate. However, as the terrain becomes more difficult, an engineer's skills and experience should match the infrastructure challenge. This will require an increasingly complex assessment of the geological condition, including soil type and slope stability, so that the road's geometric design and construction standards are suitable, and risks are managed at an appropriate level. This may require contracting a geotechnical engineer. There are few forestry geotechnical specialists in New Zealand. Specialists will



likely need geotechnical data to assess risk and provide advice. This is challenging and expensive as specialist equipment – like a Cone Penetration Testing rig – may be needed.

Geometric design and ESC

Geometric design is not generally required in green and yellow zones, however a simple road design may be necessary for an isolated section of road or landing located in difficult areas – for example, a road adjacent to a riparian margin. Geometric design is critical in orange zones with slopes > 25 degrees and in red zones to confirm the volume and extent of earthworks to meet NES-PF Regulation 24 (2) (c). It is recommended to use engineering design processes and tools like RoadEng, Civil 3D or similar, to optimise the road alignments.

Construction specifications

Operational prescriptions detailing construction specifications should be a requirement for all operations. These must be provided to contractors and operators doing the job. At a minimum they should detail the job's specifications and standards of work required. For example, they should specify the required cut and fill batter slopes, standards of compaction, and hold points for inspections and testing.

Survey and setting out

In green and yellow zones, the road centreline and landing locations should be flagged. In orange > 25 degrees and in a red zone, the extent of the earthworks should be pegged at regular intervals, typically every 20 m. The top of cuts and the toe of fill slopes should be marked with batter pegs. Roadline salvage boundaries must reflect the extent of the cut and fill. Where necessary, the extent of tree clearance should be marked to ensure enough trees will be removed for construction.

2.2 Heritage New Zealand Pouhere Taonga

Heritage New Zealand Pouhere Taonga (Heritage NZ) is the government entity with regulatory responsibilities for archaeological sites. Heritage NZ's powers and functions are prescribed by the Heritage New Zealand Pouhere Taonga Act 2014.

In much of New Zealand, and especially around the coastal margins, there are many archaeological sites. The Heritage New Zealand Pouhere Taonga Act 2014 defines an archaeological site as a place associated with pre-1900 human activity, where there may be evidence relating to the history of New Zealand. A place associated with post-1900 human activity may be declared an archaeological site under the Act. Typical archaeological sites include sites of Māori habitation such as pa sites, cultivation areas and gardens and middens, and early European activity like tramlines, tracks, roadways, bridges, wharves, mining sites and defence installations.

At the initial planning stage, it is essential to check whether there are recorded archaeological sites on the site. The central location for these is the NZ Archaeological Association which administers the site register. Charges apply for some requests and services. Visit www.archsite.org.nz/.

Another option is to contact the district and regional councils. Also, there are many sites that are not recorded so it is common to find new sites. Therefore, those doing the field surveys should know what to look for. Under the Act it is unlawful for any person to modify or destroy, or cause to be modified or destroyed, the whole or any part of an archaeological site without the prior authority of Heritage NZ.

2.2.1 Obtaining an archaeological authority

If you wish to do any work that may damage, modify or destroy an archaeological site, you must obtain an authority from Heritage NZ before you begin. This will require an archaeological assessment of the site by an archaeologist.

It is recommended that you undertake pre-application discussions with Heritage NZ during the planning stages of your project, before submitting your application form. This will ensure that the process will run as smoothly as possible.

If you uncover a previously unknown site during earthworks, you must stop any work that could affect the site and contact Heritage NZ for

2. Regulations, consents and approvals – continued



advice on how to proceed. If archaeological sites relating to Māori are discovered, then the local iwi should also be advised. Specific requirements, contacts, and forms can be obtained from www.heritage.org.nz.

2.3 The Health and Safety at Work Act

The Health and Safety at Work Act 2015 (HSWA), and associated regulations (2018), is New Zealand's workplace health and safety law. The Act is designed to ensure everyone has a role to play in health and safety. It sets out the responsibilities, and focuses on managing work risk. It requires those who create the risk to manage the risk.

Businesses need to engage with their workers and enable them to actively participate in health and safety. Engineering works which are identified as being 'hazardous works' under these regulations must be notified to WorkSafe – for example, deep trenching and when road grades are over 20% gradient.

Health and safety is a huge topic. This Manual will not replicate the health and safety requirements found elsewhere for forest engineering activities, in particular the *Approved Code of Practice for Safety and Health in Forest*

Operations (ACOP) or within individual forest company's health and safety manuals

ACOP provides practical guidance to those engaged in forestry associated work on how to meet their obligations under the Health and Safety at Work Act 2015 and its associated regulations. Refer to the WorkSafe website (worksafe.govt.nz) for information on health and safety obligations, and to download a copy of the ACOP.

Another excellent source of information is Safetree, a sector-led organisation that provides health and safety information for the plantation forest industry. It supports a safe, sustainable and professional forestry sector in partnership with workers, industry and government. Refer to safetree.nz/.

2.4 NZ Transport Agency approval for access onto state highways

The formation of new accessways and upgrading of existing accessways for increased traffic onto a state highway is controlled by the NZ Transport Agency (NZTA), as they are responsible for the safe and efficient use of the state highway network. Any new road access or change of use of an existing entranceway onto a state highway will require an approval from the NZTA.



All entranceways proposed for harvesting need to be assessed and may need to be improved to meet commercial entranceway conditions before starting harvest operations, including roadline salvage. Note that the entranceway requirements apply to all heavy vehicle movements and are not limited to just the harvesting operation.

The NZTA guidelines and standards for accessways provide the starting point for assessing the acceptability of the current entranceway. Refer to www.nzta.govt.nz/assets/resources/planning-policy-manual/docs/planning-policy-manual-appendix-5B.pdf. The rule is that should one heavy or long vehicle use the entranceway per week an assessment and likely improvement will be required. Generally, entranceways being used for commercial purposes will require upgrading with acceleration and deceleration lanes and agreed turning circle radius for the off-tracking of trailers.

NZTA has developed guideline documents and a planning policy manual to help applicants assess the effects of their planned activity and to prepare an application for an accessway that has appropriate design standards. Entranceway standards and diagrams are contained in Appendix 5B of the NZTA Planning Policy Manual which can be downloaded from the NZTA website www.nzta.govt.nz/resources/planning-policy-manual/.

A suggested process to follow is briefly outlined below:

- 1 Complete an application, making sure all the requirements have been met. Some of the key requirements are listed in the last paragraph of this subsection
- 2 Contact the NZTA safety manager for the area and get the application details – such as the entranceway position – signed off. This will most likely require a site visit with or by the NZTA safety manager
- 3 Get an approved traffic management plan. This needs to be submitted to NZTA by a site traffic management supervisor – level one (STMS). In-house STMSs can save time, costs and delays

- 4 Submit the application to the local area corridor manager for approval to work within the road corridor controlled by the NZTA (road controlling authority). They can approve, decline, or require amendments
- 5 Obtain an agreement as to work on state highway (AWaSH) permit. This is best completed in conjunction with the local corridor maintenance contractor, who will be a network control manager
- 6 At this stage, a contractor for the works needs to be identified. Generally, the NZTA prefers to have a prequalified contractor to work on the state highway corridor. The prequalification is a requirement for all tenderers for state highway work and information can be found at the following link. www.nzta.govt.nz/about-us/tenders-and-contracts/contractor-prequalification/
- 7 If you cannot get one of the prequalified contractors to do the work, or you wish to use a different contractor, then you can undertake the work, but it must meet the NZTA performance standards. For example, meet the GAP 65 and M4, compaction levels and cleg hammer readings, edge tapers and ditch gradients specifications. Entranceways will have to be chip sealed, so this needs consideration when selecting contractors.

Key factors that need to be considered in the NZTA application are:

- Location of the proposed entranceway, normally identified with route position numbers
- Expected traffic flows and the type of traffic using the entranceway
- Proposed geometry and lane width of the access and the state highway being accessed
- Highway access design, marking and signage that will need to be installed
- Sight distances where the traffic will first clearly see the activity at the entranceway
- Visual distractions (advertising signs etc)
- Average traffic speed or designated speed limit is identified and whether any traffic control speed restriction should be required
- Lighting, landscaping and vegetation which

2. Regulations, consents and approvals – continued

may cause obstruction, shading or otherwise impair visibility.

Consider seeking professional advice for state highway entrances if you do not have the level of skill or knowledge in-house. For example, it is advisable to have the entranceway surveyed and drawn up. This helps ensure the site is correctly set out and there is an accurate schedule of quantities to determine pricing.

2.5 District council approval for access onto council roads

Approval is required from the district council road controlling authority if a new access onto a district road needs to be constructed. The process is very similar to the entranceway application for the state highways.

An entranceway application, with the following information, needs to be submitted to the district council road engineer:

- Location of proposed entranceway
- Proposed traffic usage
- Visibility in either direction
- Vegetation control
- Current traffic levels and average traffic speed
- Proposed signage.

As with state highways, photographs are useful to convey many aspects of the application.

Submit the application to the district council road engineer for approval. Approval is likely to require a site visit with the engineer. The approved documentation will also include a minimum standard diagram for the district council entranceways. Note that entranceway diagrams will normally include a high strength concrete culvert with a minimum diameter of 300

mm to ensure the storm water continues to flow along the ditch.

2.5.1 Maintenance of council roads

The district council will be interested in any proposed use of a district road for forest harvest transportation. They will be concerned with the:

- Total number of heavy traffic movements
- Effect on intersections
- Impact on road pavements
- Impacts on infrastructure such as bridges
- Dust and the impact on residents
- Planned time of the year for works
- Alternative routes or single route allocation.

Councils in some areas of New Zealand are challenged by the rapidly increasing log volumes on their roads. It is difficult for councils especially when upgrades and maintenance do not account for high cart volumes, all season operations, or an increasing number of back blocks being harvested. Often councils have limited funds available to upgrade or maintain rural roads. This can be most acute for small rural councils with a high concentration of plantation forestry.

Councils need advanced warning that a specific road's traffic volume will increase to enable any necessary upgrade or maintenance to be planned and budgeted. Consider providing councils with estimated traffic volumes and durations well in advance of harvesting a new block, to give them time to work with you on getting the council road up to logging specifications, and to confirm that the proposed route is suitable. Also, it is advised to make submissions on the council's long-term council community plan (LTCCP) – this details the council's proposed plans.



Chapter 3

Planning for roads



3. Planning for roads

This chapter describes the laying out of the roadline from the initial paper plan, through field validation, to the final layout, ready for construction.

Planning is a critical component of any successful road construction programme, and is part of the broader harvest planning process. In commercial forests, the primary purpose of forest roads is to provide suitable access for forestry operations. A good planner intimately knows the area they are working in, has a broad skill set, and uses a suite of available tools to assist in decision-making.

Planning infrastructure for harvesting involves linking roads to the best extraction sites or ‘landings’ (see Chapter 4 for more detail). In harvest planning, locating landings are a priority because their position is critical in ensuring efficient harvesting operations.

While building roads is expensive, the road building cost per unit volume harvested is typically much less than the harvesting costs. However, it is not always possible to get a road to the optimum landing site. For example, there may be safety, environmental or economic constraints. The outcome is a trade-off where the landing position is changed, or an alternative harvesting system is used, for example, two-staging.

The figure below sets out the typical planning steps for locating, designing and field layout of the roadline. For roads on relatively flat or rolling terrain, with good soil working conditions, an experienced road construction crew and a clear set of road standards, a flagged grade line might be all that is required for construction to proceed. However, roads on steep terrain needing extensive earthworks, or those having to cross waterways, will benefit from (or require) a more detailed plan, referred to as a full road design. Each step in this planning process is described in more detail in this chapter.

3.1 Road classes

A key input to roadline planning is the road specification (also called the road standard); these vary with the purpose of the road. They include the required width, maximum grade and curve radius. These parameters should be clearly defined so that they are consistent with the proposed harvest plan.

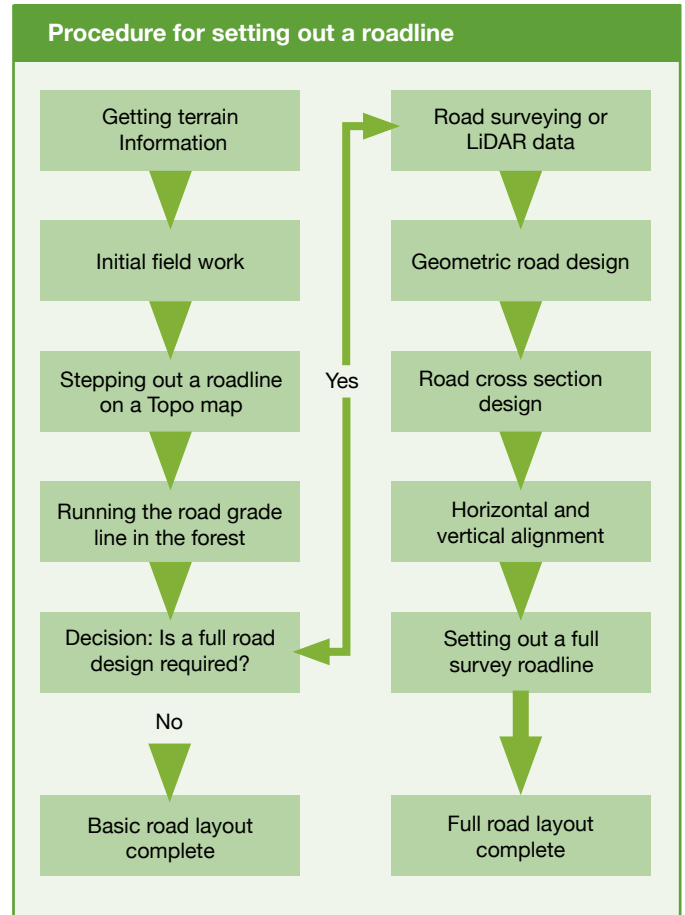

Planning, designing and setting out a roadline

Many forest companies develop their own set of road standards to suit their specific needs and conditions. Standards may need to be flexible. For example, the maximum grade may need to be exceeded for very short segments in difficult terrain to reach a critical control point like a river crossing or landing, or to meet environmental requirements.

Note that WorkSafe’s *Approved Code of Practice for Safety and Health in Forest Operations* states that the maximum grade for any road used for log cartage with on-highway trucks is not to exceed 20% (or 11 degrees) at its steepest. The exception is that roads used by off-highway or other specialist vehicles may be steeper, provided:

- They are designed to cope with the steeper gradient; and

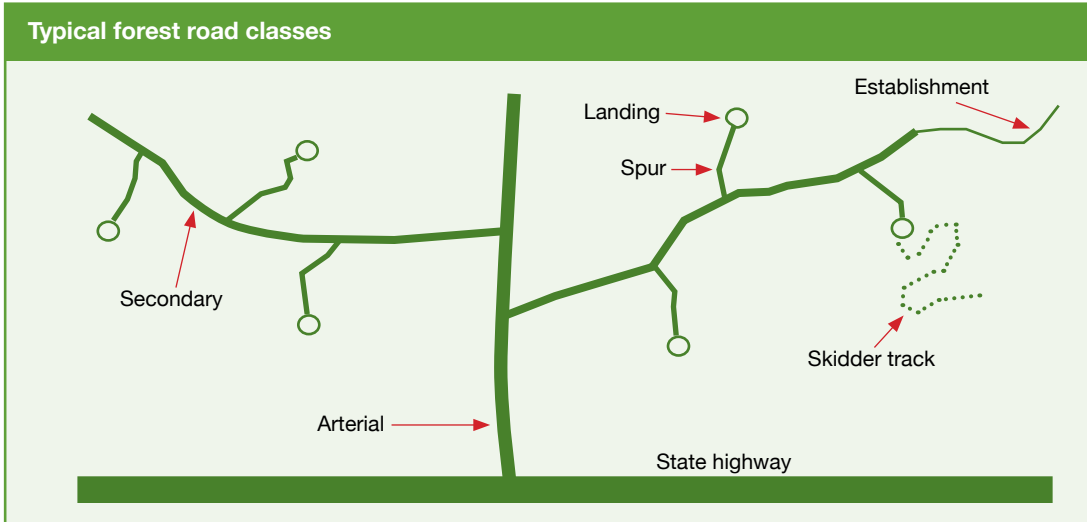

- The operation has a written site-specific hazard control procedure.

A commonly used set of road standards for forest roads is divided into four broad classes or categories:

- Arterial
- Secondary
- Spur
- Establishment.

3.2 Arterial roads

Arterial roads traverse through major forests and are typically permanent two-lane unsealed roads. In some exceptional circumstances, where the road acts as a major thoroughfare, as in Kaingaroa, they may be sealed. Sealing is justified where the additional construction cost is offset by the reduced road and vehicle maintenance cost.

Many smaller forests do not have arterial standard roads. Arterial roads generally:

- Carry more than 80 heavy vehicles per day or greater than 250,000 tonnes per year
- On flat and rolling terrain, have a road width of 9 m, desirable maximum adverse gradient of 8% or 10% for short distances and are designed for speeds of 70 km/hr. Adverse grades are uphill loaded for a truck or vehicle
- On mountainous terrain, have a road width of 8 m, desirable maximum adverse gradient of 10% or 12% for short distances, and are designed for speeds of 50 km/hr.



A sealed forest arterial road

3.3 Secondary roads

Many forestry roads are built to secondary road specifications, especially in forest blocks in the 1,000 to 15,000 ha range. They are unsealed, permanent one or two-lane roads constructed to a high standard.

They generally:

- Carry between 20 and 80 heavy vehicles per day or between 60,000 to 250,000 tonnes per year
- On flat and rolling terrain, have a road width of 7-8 m, desirable maximum adverse grades of 10% or 12% for short distances, and are designed for a speed of 50 km/hr
- On mountainous terrain, have a road width of 6-7 m, are designed for a speed of 40 km/hr, and desirable maximum adverse grades of 12% or 14% for short distances.

3. Planning for roads – continued



A typical one-lane secondary road. The widened shoulder on the left provides room to allow opposing traffic to pass

However, the road width is commonly reduced to 4.5-5 m, to reduce construction costs. In this case, full-width sections are required at regular intervals to allow opposing traffic to pass. Consider keeping road grades for 50 Max and HPMV trucks to 12.5% adverse loaded for all terrain unless the road surface is designed for these units. Also, incorporate more width on corners for off-tracking 50 Max and HPMV than for standard 4 axle trailer units.

3.4 Spur roads

Spur roads are often one lane, and are constructed to a pavement standard that can reliably support short-term logging traffic. They typically provide access to one or two landings, and are used only during harvest and subsequent silvicultural operations. During harvesting, the traffic volume can be heavy and intensive, but they will only be used one to three months in every rotation.

They generally:

- Carry less than 20 heavy vehicles per day or less than 60,000 tonnes per year
- On flat and rolling terrain, have a road width of 4.5 m, desirable maximum adverse grades of 12% or 14% for short distances, and are designed for a speed of 40 km/hr

- On mountainous terrain roads, width might be reduced to 4 m and be designed for speed down to 30 km/hr. This will reduce the amount of earthworks required to construct the road in steep terrain. The maximum adverse grades can be 18% for short distances where the road design and surface has been specifically designed for this.

Again, consider keeping road grades for 50 Max and HPMV trucks to 12.5% adverse loaded for all terrain unless the road is specifically designed for these units. Also incorporate more width on corners for off tracking 50 Max and HPMV than for standard 4 axle trailers.



A typical spur road ending at a landing

3.5 Establishment tracks

Establishment tracks are one lane and do not have an improvement layer, although a thin layer of gravel might be applied to help stabilise the surface. They are used to access new areas for planting and silviculture, and typically carry light vehicles only. They are generally more suited to 4-wheel drive.

Establishment tracks are designed for low speed and dry weather access. They often have a road width of around 2.5-3 m. They can be steep, up to a maximum adverse gradient of 17% or 20% for short distances.

Many establishment tracks are upgraded to secondary or spur roads at harvest. Consequently, planners should consider designing new establishment tracks with geometries and grades that can support log hauling operations.



A typical establishment track, gated to restrict access and grassed to eliminate on-going erosion

3.6 Spatial information

Spatial information is vital to effectively plan for roads, landings and harvesting. Information can be obtained in the form of topographical maps, aerial imagery and bio-physical maps like soils, geology and rainfall. Aerial imagery refers to images taken from any flying object (drone, plane or satellite). Spatial information is obtained from processing data from various sources.

Harvest and road planners have more geospatial information available than ever before. It is a rapidly growing area for both data collection and post-processing. The once common techniques of using non-orthorectified stereo photo pairs and a stereoscope to see a three-dimensional view of the topography are now seldom used.

Aerial imagery, from a source such as Google Maps or GoogleEarth, is now at the simple end of tools that range from proprietary aerial imagery in visible, infrared, or multi-spectral ranges. Such software also gives a 3-D view from various aspects, as well as checks for physical features such as buildings or powerlines.

Light detection and ranging (LiDAR) is now widespread, and allows high resolution digital terrain maps and 3-D models to be generated at relatively low cost. Satellite imagery can also be used by forestry companies to get regular forest image updates, to measure operational and forest changes in real time. Regional councils

also have another source of good information – orthorectified photo coverage.

Most purchased imagery, or that sourced through Land Information New Zealand (LINZ) or regional councils, will be orthorectified, distortion corrected and positioned to a grid system. However, in-house imagery from an unmanned aerial vehicle (UAV), such as a drone, needs to be orthorectified so it can be overlain with other spatial data.

For all geospatial imagery, consideration should be given to the date of acquisition because landscape features change over time. However, planners should also consider historic geospatial data sources like old photos, as these can be an excellent resource and as useful as recent photos. Aerial photographs taken without extensive tree cover can often be sourced for plantation forests that were originally planted on ex-farmland. These generally provide the best indication of visible ground features, such as bluffs, wetlands and suitable river crossings. For example, identifying pre-planting slip locations for areas in the East Coast and Hawkes Bay with extensive post-cyclone Bola erosion. UAVs or drones are also rapidly becoming geospatial data collectors, supporting in-field planning and road inspections.

A topographical map is defined as a map showing natural and/or physical features of a landscape, including altitude contours. Topographical maps at 1:50,000 scale with 20 m contour intervals are freely available to download from NZ Topo Map (www.topomap.co.nz). Many forest owners have produced higher resolution maps of their forests with 5 m contour intervals using aerial imagery and control points, but this is becoming superseded by LiDAR, which can produce maps with 1 m contour intervals. For forest areas without landowner LiDAR, coverage, check with the regional council as many are starting to make larger scale LiDAR data available.

A common database for topographic and other information layers is available from LINZ (www.linz.govt.nz/data/linz-data/elevation-data). It is important to identify how the topographic data

3. Planning for roads – continued

was compiled, as the contour details and other map features are only as accurate as the base data from which the map was originally drawn. For example, working with 1:50,000 maps using 20 m contour data is reasonable for the initial feasibility plan, as well as for checking how the overall roading network will work. A final roading plan should be made on 1:5,000 scale maps.

New technologies are rapidly making road design easier and more accurate. Most planners can now modify maps using Geographic Information Systems (GIS) to display the information pertinent for their required map. For example, the map below overlays the planned landing areas with a LiDAR shaded map not only to see the existing road network but also existing slip areas.

The level of LiDAR detail can be incredible, even with full canopy closure. For example, old farm tracks that might not be readily identified on the ground may be clearly visible. If they are on the desired grade, they can often easily be upgraded to a forest road.



LiDAR based topographical map with 5 m contour, showing waterways (blue lines), stand boundaries (red lines) and planned landings (green rectangles)

The availability of quality terrain data allows the forest engineer to undertake more extensive and useful preliminary planning in the office before heading into the field. LiDAR generated contour data, and GIS road location spatial data, can be uploaded into engineering road design software programmes. This means alternative road routes (and their feasibility for large lengths of road), construction costs, earthworks volumes, and the environmental impact can be assessed rapidly for each option. The final road design can be downloaded into GPS units for field layout. This can potentially lead to the forest road location being pegged out without standard surveying equipment.



This map shows a combination of geospatial elements, including the harvest setting boundaries, the road, waterways, native vegetation and the landing (red dot)

Other spatial data is essential to help develop comprehensive plans. These can include the NES-PF ESC (erosion susceptibility classification) and fish spawning layers, property boundaries, hydrology (waterways), ground cover, existing roads, buried services and features such as overhead transmission lines, and archaeological sites. Soil maps are a useful resource as they show soil types and soil properties (soil pH, textures, organic matter, depths of horizons etc). Many soil maps have been published accompanied by a large compendium of soil descriptions and characteristics. The most readily available database is hosted by Landcare Research at smap.landcareresearch.co.nz/. The database is being updated through extensive field work and



validation. In some regions there is excellent detail available, other regions are still being worked on and still have very broad basic details.

3.7 Initial field work

For most roading projects, there is no substitute for 'walking the block'. That is, getting out and looking first-hand at the forest area where new roads are being proposed. This will provide an overview of the site before any detailed planning work begins, especially where you're unfamiliar with the block. The field overview assists with the interpretation of aerial photographs and maps that are used in the paper plan.

For smaller scale roading projects on known terrain, such as laying out a small spur road to a landing, the initial field work might be done at the same time the road grade is being laid out. In this situation, it is acceptable to lay out a proposed segment of road on the topo map as described in the next section.

As walking the block can be very time consuming, it is recommended to highlight areas of concern when assessing the terrain information to help focus the field visit. In addition to inspecting obvious features such as waterways, buildings and powerlines, the initial visit should also check for potential 'problem' features including:

- Rock bluffs and localised steep terrain
- Unstable soils and recent slips
- Environmentally sensitive areas such as wetlands
- Culturally sensitive areas such as pa, pits, middens and waahi tapu sites
- Utility services. For example, sewer, communications, water, power cables (both underground and overhead).

Where identified, these features should be recorded and preferably added to GIS data. If any of these features constitutes a hazard for road construction operations, there is also a legal requirement to both identify and transfer this information to the roading contractors. Recording this information on the detailed road plan map is the most acceptable way of transferring this information.

The local council or utility company will be able to provide information about utility services. A plan to manage safety and environmental risks can be developed and shared. Inadvertent contact or rupture is a significant risk to workers and a business. They have the potential to harm and/or damage the environment.

3.8 Manual design method: Stepping out a roadline on a topo

For larger or more complex projects, it will be worthwhile to 'walk the block' prior to developing map-based plans to get a good idea of the terrain (see section 3.9). However, stepping out roadline alternatives on your contour map can help guide the feasibility of road options, and help guide what areas of the block you should focus on during the site visit. As part of good environmental practice, you should always plan two alternative routes for each new segment of road. Once they have been checked in the field, you will then be able to select the best alternative and make a clear case that a lower impact road option has been chosen.

Stepping out a road is a simple and effective technique for plotting a roadline of a given average grade using contour maps. The diagram on page 32 shows a roadline marked on a contour map, with control points at A, B, C and D.

The procedure for stepping out a roadline is:

1. Mark known control points on the map

Positive control points are points which the road must pass through. They include:

- Start point or area (usually an existing road)
- Finish point (landing)
- Preferred river crossing sites
- Other points that the road must pass through (for example, other landings)

Negative control points are areas that the road must avoid. They include:

- Rocky bluffs or unstable soil areas (active slips)
- Wetlands
- Cultural sites requiring protection
- Water intake structures.

3. Planning for roads – continued

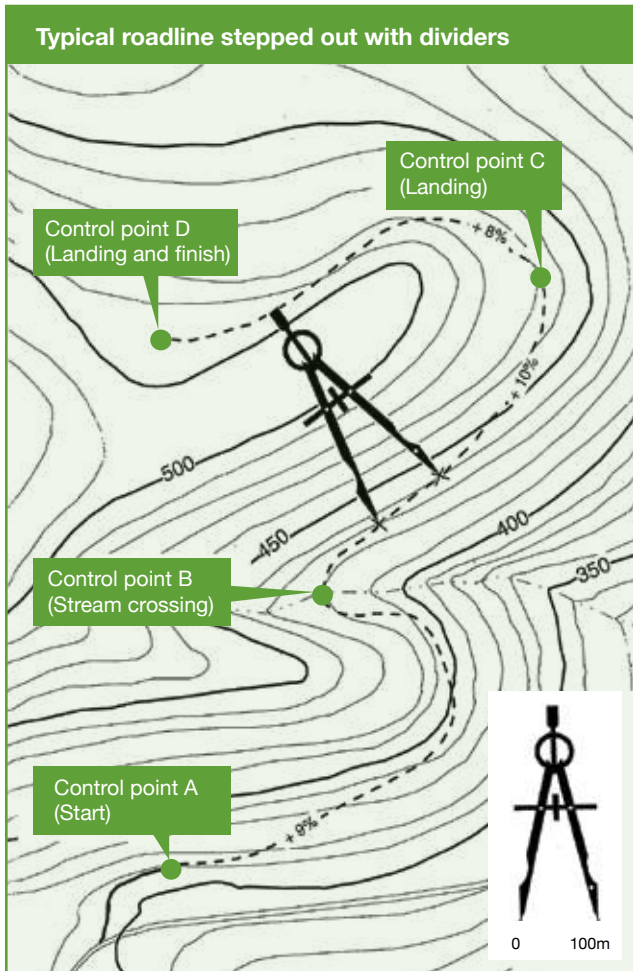

(Source: Walbridge, 1997)

2. Determine an appropriate grade

The road grade is the slope of the road and should be presented in percent, but it is still sometimes given as a ratio. Road grade in percent is the ratio of the rise over run; for a given road segment this is the difference in elevation over the length of the road segment.

For example, a 150 m road that gains 15 m in elevation is a road at $15 / 150 \times 100\% = 10\%$ grade. A road at 10% can also be represented as a '1 in 10' ratio.

Road grade should not be presented in degrees (degrees are used for angles, not slope). If you come across road standard information using degrees or ratios, the table top right is useful to convert between the different methods of measuring grade.

Percent and degree relationship		
Percent	1 in x	Degrees
0	-	0
1	100	0.6
2	50	1.1
3	33.3	1.7
4	25	2.3
5	20	2.9
6	15.7	3.4
7	14.3	4.0
8	12.5	4.6
9	11.1	5.1
10	10	5.7
11	9.1	6.3
12	8.3	6.8
13	7.7	7.4
14	7.1	8.0
15	6.7	8.6
16	5.7	9.1

Relationship between percent, 1 in x, and degrees

Ideally, a segment of road should be planned to have the lowest possible average grade, which should not exceed the maximum grade given by the road standard. For example, a secondary road where trucks are expected to operate at speed might have a maximum grade limit of 10%, whereas a small spur road might have a maximum grade of 14% (for trucks travelling loaded, or a maximum of 16% unloaded).

There are specific locations where the grade needs to be lower, or even become flat (ie 0%). These include rivers crossing approaches, crossings saddles, on curves and around tight ridges. Approaching landings and road intersections, the maximum grade should be < 6% for at least 30 m to ensure that trucks can stop and move off safely.

To obtain the lowest possible grade from a map, the elevations of the control points are measured using the contours on the topographical map. The distance between the control points is measured with a ruler on the map, and the



map scale is then used to determine the actual distance. Alternatively, a scale rule can be used, and the distance read directly from it.

Then, the average grade between adjacent control points can be calculated using the following formula:

$$G = \frac{100 \times (E_B - E_A)}{D_{AB}}$$

Where:

G is the average grade between control points A and B (%)

EA, EB are the elevations at points A and B

DAB is the distance between A and B

Worked example

The elevation of control points A and B are read from the topographical map as: EA = 240 m, EB = 270 m. The distance between A and B is measured and scaled as: DAB = 495 m. The average grade can then be calculated:

$$G = \frac{100 \times (270 - 240)}{495} = 6.1\%$$

3. Step out the road between the control points using dividers

It is recommended to start stepping out a planned road on a map from a control point such as a landing or river crossing, and work outwards from these points to establish the location of the remainder of the road. The reason for this is that there is less option to move these than the intervening road sections.

Set the dividers to a distance which will achieve the required grade between adjacent contours (Note: You can also use a ruler). This distance is given by the following formula:

$$D_{Divider} = \frac{D_{Cont} \times 100,000}{(G \times X)}$$

Where:

D_{Divider} is the spacing that the divider is to be set to (m)

D_{Cont} is the map contour interval (m)

G is the average grade determined in step 2 (%)

X is the map scale (1:X).

The dividers are then used to step out a trial road between the two control points. Start at the most critical control point, then step from one contour to the next until the end control point is reached. Sketch the roadline along the points that were marked by the dividers on the contours.

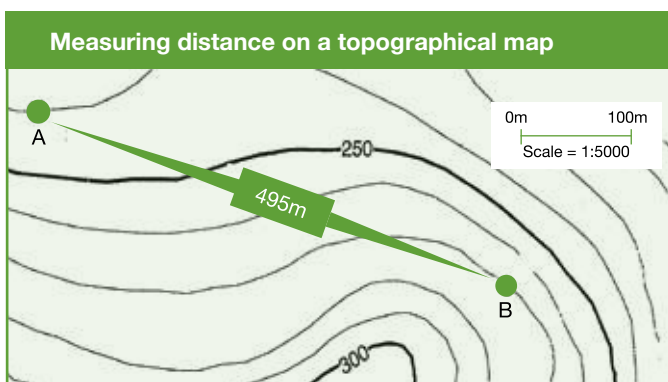

Source: Walbridge, 1997

That is, if we lay the road out on the map or in the field, at 6.1%, we will have a road on a constant grade between the two points. However, if the calculated grade between two points exceeds the maximum allowable grade, then we must use the maximum allowable grade and extend the road length using curves or switchbacks.

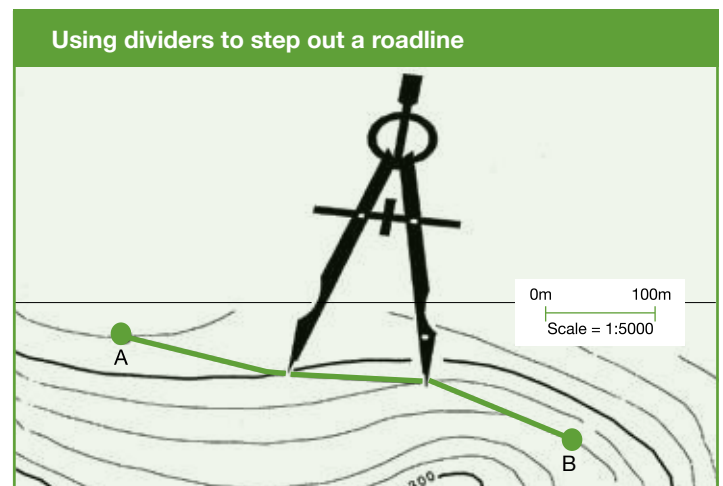

Source: Walbridge, 1997

3. Planning for roads – continued

Plotting a roadline on the topographical map is only an initial step to ensure that the proposed road is feasible. This roadline must be checked on site, re-marked on the topographical map, and then correctly set out in the field by running a grade line.

The above steps are identical for working on digital maps such as in GIS, Google Maps and Google Earth, whereby most mapping software has a ruler function that can be used directly in the application.

3.9 Running a grade line in the field

The following is a basic technique to mark the proposed grade line, also called the P-Line, in relatively easy topography that has uniform cross slopes, and rolling topography, where a benched side-cut road formation is the likely construction method. On steep broken country, or areas requiring more complex roading such as block cuts or switch backs, the grade line or P-Line needs to be more carefully laid out so that the final road location reflects the actual plan. The grade line is then augmented with more detailed survey information to create a corridor within which the road will be designed (see section 3.10).

As per the paper plan, normally more than one trial grade would need to be run to coincide with the control points to identify the best alternative. Grade lines can be set with an Abney level or clinometer. Clinometers are the most common instrument, but they can be difficult to sight with in low light levels. It is essential to check the calibration of the instrument in case it has been damaged, and especially the units used; most clinometers will show the angle in both percent and degrees.

Marking a proposed grade line in the field is done by placing flagging, also called marking tape, on trees or bushes at eye level approximately 20 m apart. Flagging is preferred to paint as it is easier to see and adjust if an alternative line is decided upon. The distance between stations generally depends on the line of vision. In thicker scrub, flagging may only be 10 m apart, or foliage may need to be removed with a slasher.

Marking out the grade line is more accurate,

faster and safer if done by a two-person team (see the illustration below). With a two-person team, the person with Abney level starts by setting a ribbon at eye height on a tree or bush, sending the second person ahead about 20 m in-line. The Abney holder directs the second person to stand next to a tree which is nearly 'on grade'. This person holds out the ribbon at the eye height of the Abney holder and, as directed, moves up or down the side slope until 'on grade'. A ribbon is attached to a nearby tree or bush at this elevation. This procedure is repeated until the start and finish control points have been joined.

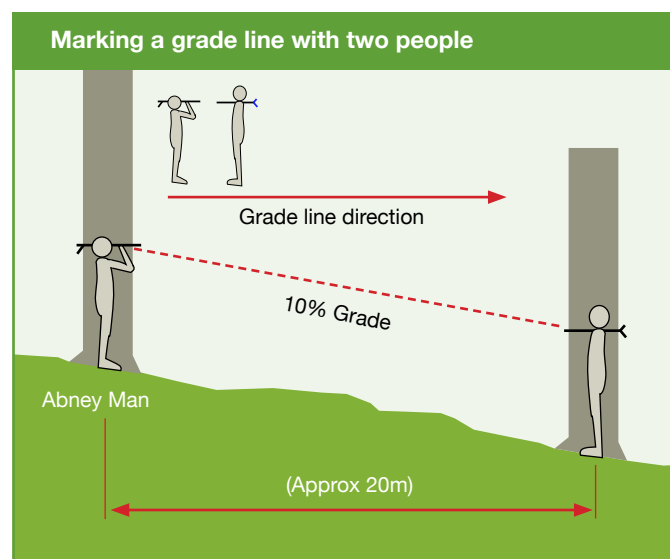

Source: Walbridge, 1997

If only one person is available, grade lines can be set by pacing ahead of a grade mark, turning around, and then moving up and down the side slope until the grade is met. At this point, another grade mark is set and the procedure is repeated until the desired control point is reached.

Difficulties in maintaining a gradient can occur when:

- Adjusting the grade line to accommodate intermediate control point(s)
- Crossing a steep side gully
- Going around a long sharp ridge or requiring to block cut through it
- Continuing around a switchback.



Consider full road design, especially where the road grade is approaching maximum limits, terrain is steep, and where other factors need careful operational planning.

Roadline salvage operations, where the trees are removed before road construction, are likely to remove or disturb the marking tape and grade lines may need to be re-established.

3.10 Full road design

A key step is deciding whether a full road design is required. A full road design can be time-consuming and challenging due to the surveying requirements, detailed design work, the laying out of the pegs in the field, and the need for road construction operators who can follow the plans.

A full road design provides detailed plans for road and skid construction. At any point on the proposed infrastructure, the location and earthwork details around quantities of cut or fill, and specifics like cut slope height and the location of the toe of the fill, are known. In order to get this level of detail, the base information needs to be precise, otherwise the plans will not be accurate. Larger roading projects will typically be a combination of sections laid out directly in the field, with full design for only the

more challenging segments, such as those with extensive earthmoving, where it cuts across steep terrain, or where switchbacks are required.

Advantages of undertaking a full geometric road design include:

- The cost of road construction is likely to be reduced, because alternatives can be evaluated and the optimum design selected
- There is greater reliability that the required road width will be achieved and the maximum gradient limits on the road will not be exceeded in the final road construction
- The earthworks volumes can be predicted in advance, so the cost of construction can be estimated with better accuracy and reliability
- The height of batter slopes can be predicted in advance for consent purposes
- Better set-out information can be provided to the construction crew or contractor
- Better decisions can be made as to whether a road is feasible in marginal locations

3. Planning for roads – continued

- The design software can assist in minimising cut and fill depths
- Where the road is designed and pegged accurately, a corridor can be marked to fell only the necessary trees, thereby minimising the number of roadline trees to be felled. For example, this may be important in areas that are susceptible to windthrow.

Full road design is best done by those who have planned the approximate road and landing locations. They will have the big picture view of what they want to achieve and, having walked the terrain, a good sense of where the potential construction challenges lie.

Designing roads requires competent technical skills. If these are not available in-house, then contract the work out to a professional.

3.11 Working with road survey data

A full road design requires detailed road survey data to allow for accurate feasibility assessment, including vertical and horizontal road location, and calculating earthwork volumes. A detailed road survey is effectively accurate terrain information of the grade line (P-Line) corridor. Because of the high level of detail required, contour map information derived from aerial photography is not adequate. The best source of information is LIDAR-derived digital terrain models (at the 1 m level), however a more traditional survey also yields very good results. While traditional survey data also lends itself to manual planning processes using paper plans, software is now commonly available to support the design process. As such, the survey data needs to be captured in a form that can readily be used by the software.

The traditional survey method requires equipment that is readily available:

- Fibreglass tape
- Clinometer
- Compass
- Field book
- Flagging tape and waterproof marker pen
- Stakes (optional).

Modern surveying equipment may prove to be a more effective method. For example, a laser rangefinder that incorporates a compass replaces the need for a measuring tape, clinometer and a compass. It is possible for a laser rangefinder to be linked to a data-logger for direct capture of survey data, which eliminates a notebook.

The survey moves along the grade line or P-Line that approximates the road centreline, that has been established in the forest. This ensures that the road survey traverse is reasonably close to the final road location, thereby reduce errors and problems when designing the roadline.

The survey involves measuring cross sections at regular intervals, so that a three-dimensional model of the terrain along the proposed road corridor is established. From this, the design plan line, longitudinal section and cross-sections can be produced. There are many variations in road surveying methods and in the setting out of a field book; these mostly depend on personal preference or established formats.

One method of a standard forest road survey, that is consistent with the input required for RoadEng, is outlined below:

- Establish stations at 20 m intervals or less, or where the terrain allows, near the proposed road centreline or grade line (the road centreline may be adjusted left or right after geometric design has optimised the location). Stations should also be located at gradient changes in the existing topography, that is, at the base of slopes, on ridges and in hollows. Marking stakes are often used to mark the survey station points, or the nearest available tree is marked as a station. These stations are labelled 1, 2, 3 ... or the distance from the start, for future reference. These station locations are used for final design roadline set-out
- Record compass bearing, gradient (%) and slope distance from station to station. If a laser rangefinder is used, the horizontal and vertical distance between stations can be read directly. Note that errors accumulate so carefully take and record data
- Record cross sections, by measuring slope

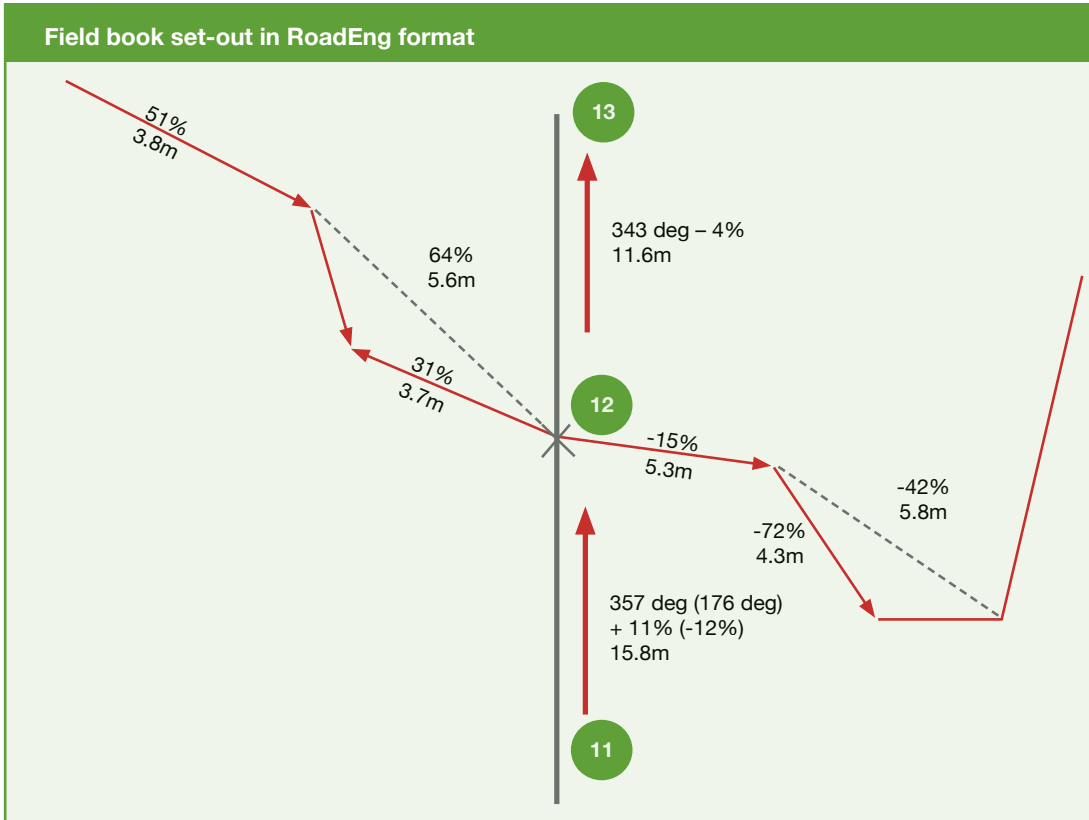

and distance to sample points on a line perpendicular to the survey traverse line

- Measure slope in %; downhill slopes are recorded in negative values
- Measure the slope and distance of side-shots, also called cross sections, from point to point, or from a change point to point. Point to point is where the surveying leap-frogs to the next point to take a measurement, while change point to point is where the surveyor stands in one position to take several side-shots. The choice depends on the easiest method in the field, and on the road design software used. Change point is likely to be more accurate as error isn't accumulated. The number of side-shots taken needs to adequately represent the ground surface.

See page 38 for a schematic representation.

It is important to realise that the survey stations are not necessarily the same as the grade line marks. The survey stations represent changes in topography, and it is common to put stakes into the ground to represent survey stations, rather

than to use marking tape on trees. The stakes can be easily distinguished and placed where needed rather than having to use a nearby tree.

Reference points are useful on the survey line. These are points that are outside of the roadline salvage width so known points can be re-established after felling.

A survey field book should be used to facilitate accurately recording the information and speeding up the process. An example of a field book can be seen above. However, a common mistake is to miss out the negative sign for a downhill slope, which could go unnoticed without a sketch of the cross-section. Tabular methods are recommended only for experienced survey crews.

3.12 Geometric road design

Geometric road design involves the optimisation of the horizontal and vertical alignment of the proposed road by adjusting the position of road design points to find the best fit to the terrain for the given design parameters. While this process can be carried out manually, it is very time consuming, and road design software is now

3. Planning for roads – continued

Recording slope, bearing and slope distance between survey stations

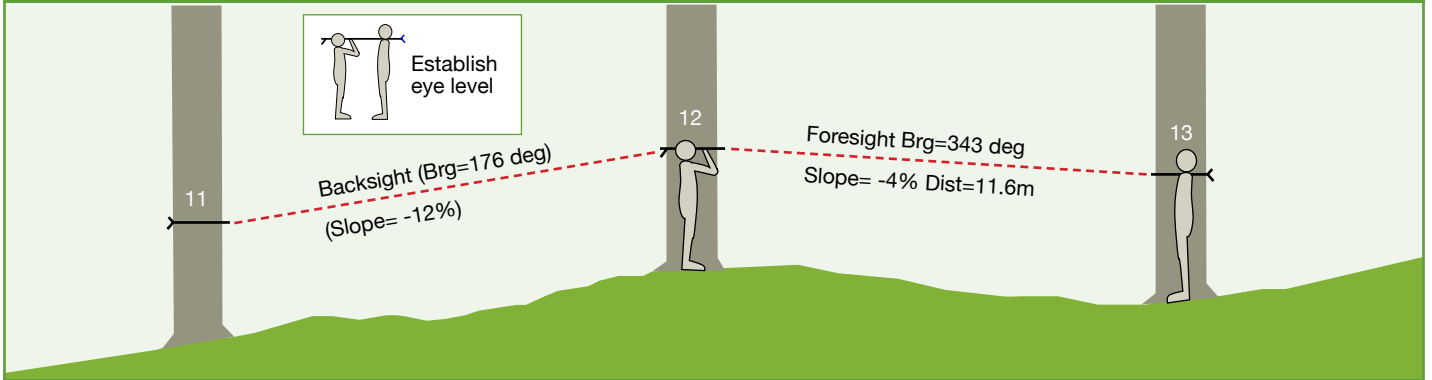

Source: Walbridge, 1997

Measuring the slope and slope distance for left and right cross sections

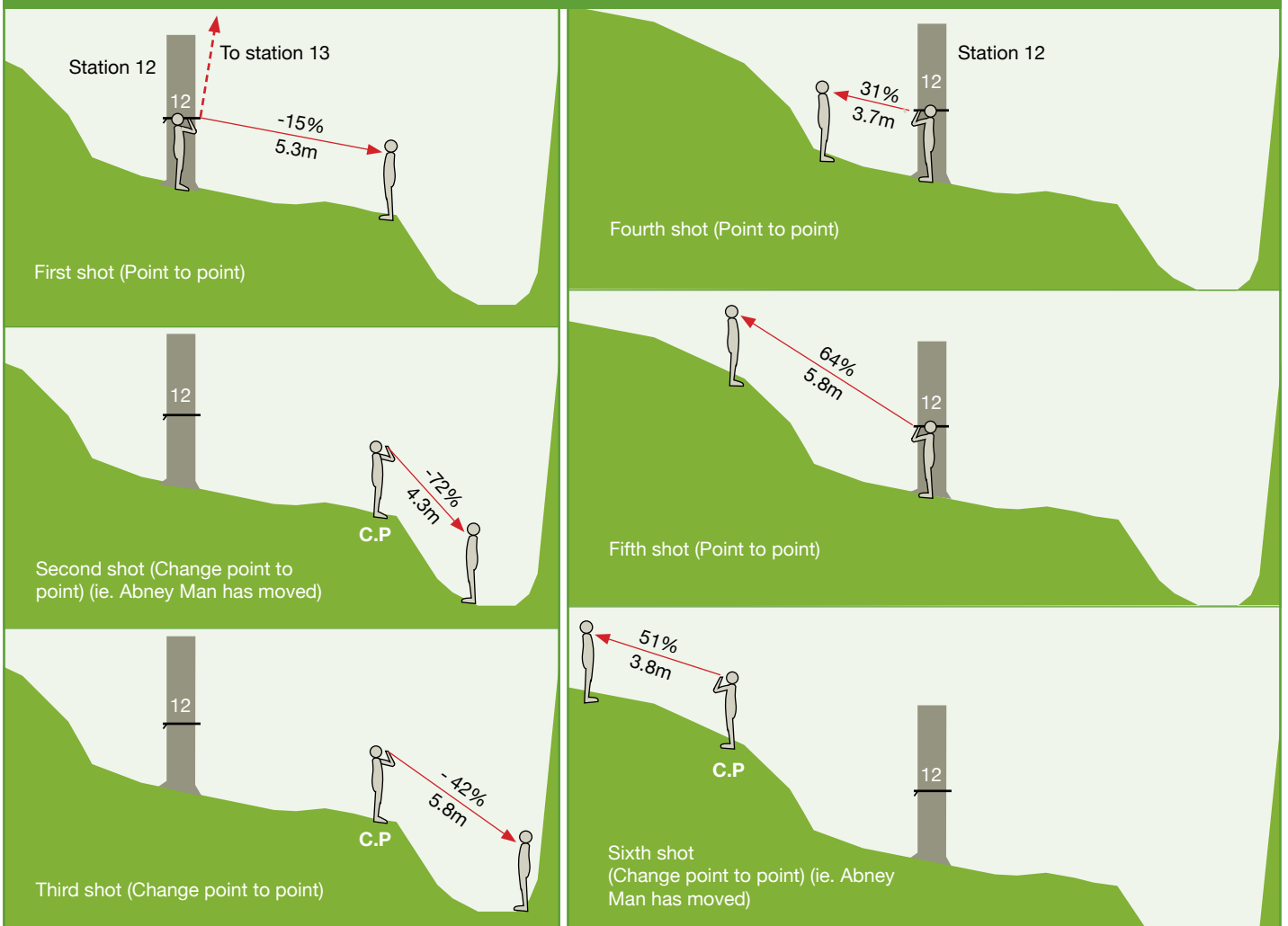

Source: Walbridge, 1997



Full road design requires contractors that understand and can follow the plans.

used to undertake this process and also assist in the design of curves, curve widening, ditches, and culverts.

The process of geometric road design for forests is more efficiently achieved using a specialised road design software package. Some examples are ROADENG, Civil3D, GEOCOMP, LUMBERJACK, and SDR Mapping and Design. These programs are fairly easily used by people who understand the basic principles of terrain modelling.

It is important to realise that computer road design software packages are only a tool to assist the designer. The design packages do not automatically produce a design which will be optimum. The final design is only as good as the user's expertise in geometric road design. A good knowledge is required of how combinations of grade and curve radii restrict truck maneuverability.

See page 40 for a schematic representation. Appropriate road cross sections need to be

determined for use in the road design. The road cross section (or template) may be different for various sections of the road. It is essential that the site soil, geology, topography and other features are understood. For example, the cut slope angle may change depending on the soil type in the hillside, or additional widening may be required on corners to accommodate the inside tracking of trailing axles.

A major cause of road deterioration is water entering the pavement. This is commonly due to the road surface having insufficient side-slope (crossfall) or the ditches being too shallow to keep the subgrade soils free of saturation. On secondary or spur roads, a crossfall of 4-6% is needed for water to runoff and not to sit on the pavement, whereas on a higher standard arterial road a crossfall of 2-3% might be more appropriate to improve safety for higher speed traffic. The shedding of water will help prevent potholes from developing. For a two-lane road, the crossfall should always meet at the centre

3. Planning for roads – continued

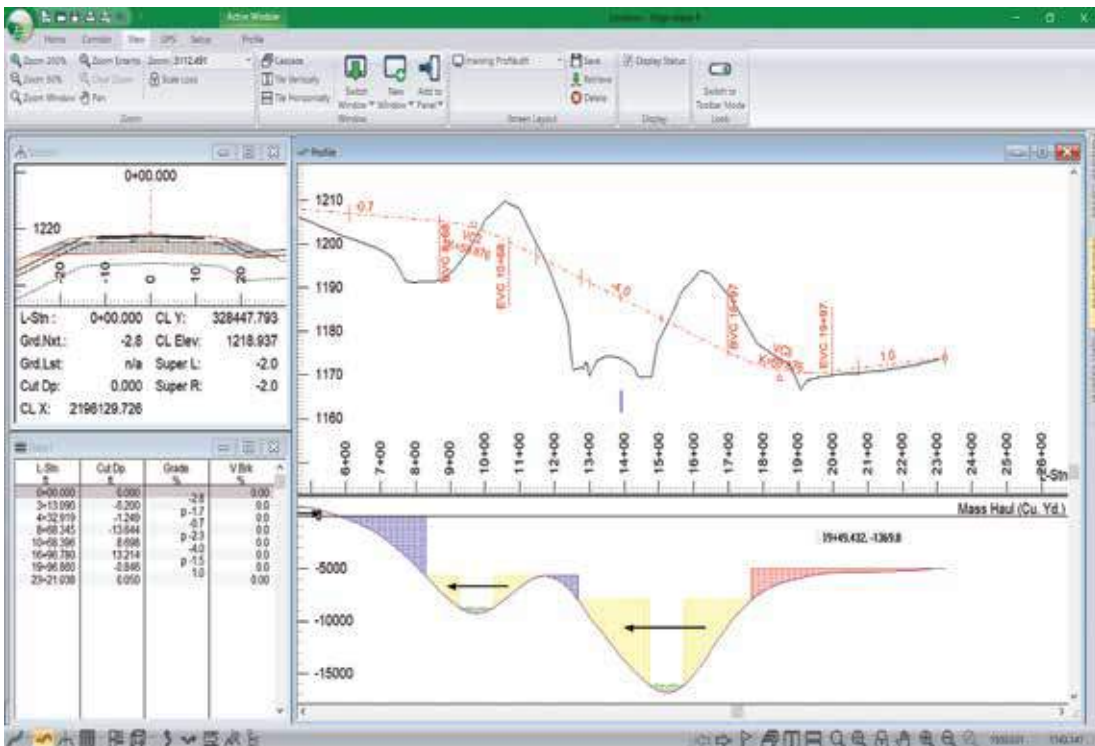
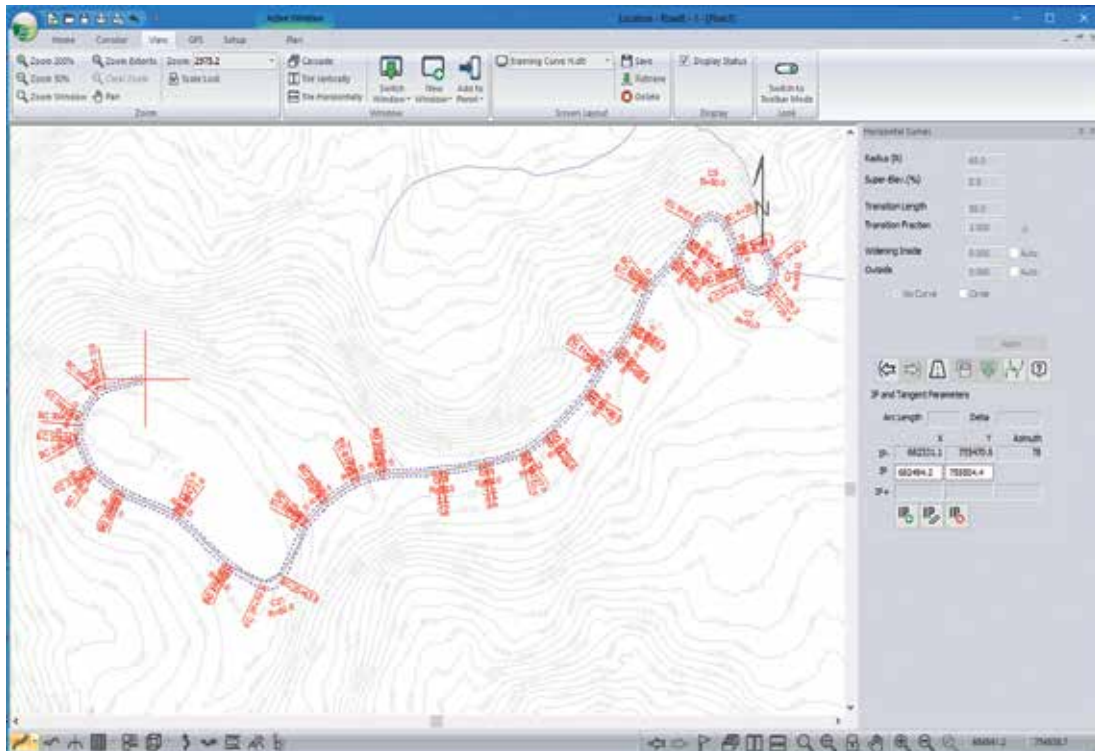

Plan and cross section windows using RoadEng for road design. The cross section shows the road template and the level of cut and fill. The blue line on the plan figure shows the road width and the green lines indicate the limits of the cut and fill slope

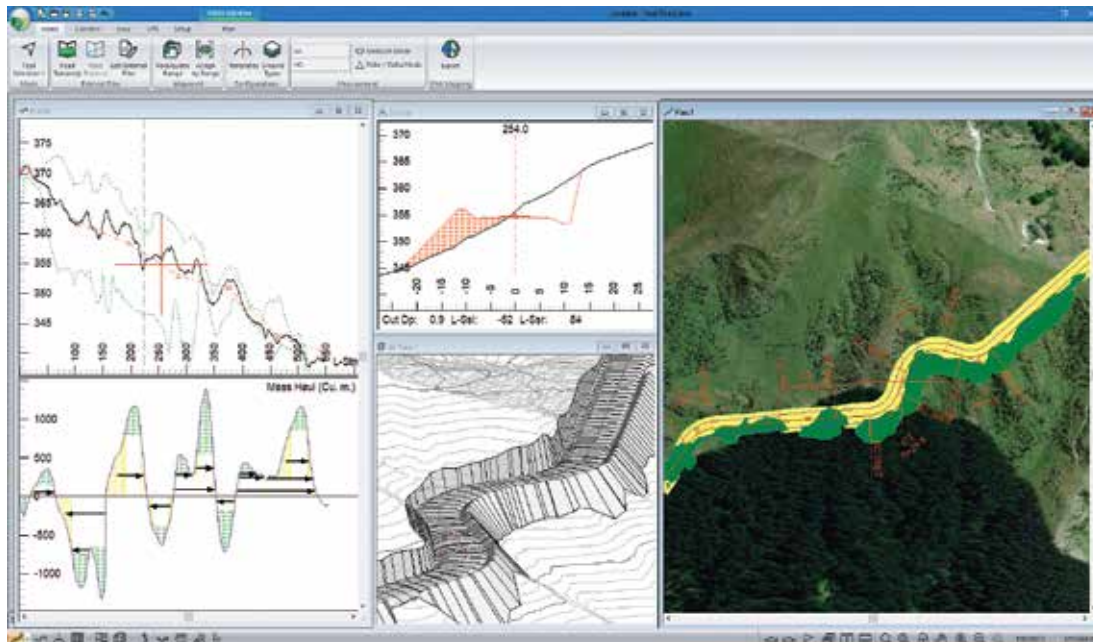

Additional outputs from RoadEng including one view of a 3-D road model to help visualise the road prior to construction

of the road, producing a crown. For a single-lane road, crossfall may be to both sides, or for maintenance purposes it may be easier to have the fall to one side only.

Avoid excessive crossfall and corner superelevation on steep gradients, because of the risk of roll-over and the tendency to remove weight from driven wheels on the high side of the road. The actual crossfall selected may need to be a compromise between that required for

drainage, and that suitable for heavy vehicles.

For low speed forestry roads, superelevation is not normally used, but in some cases of climbing adverse loaded corners, negative super elevation is used to improve truck gradeability by providing an improved distribution of weight to the drive axles.

Explanatory notes for the diagram below and those on page 42 are on the next page:

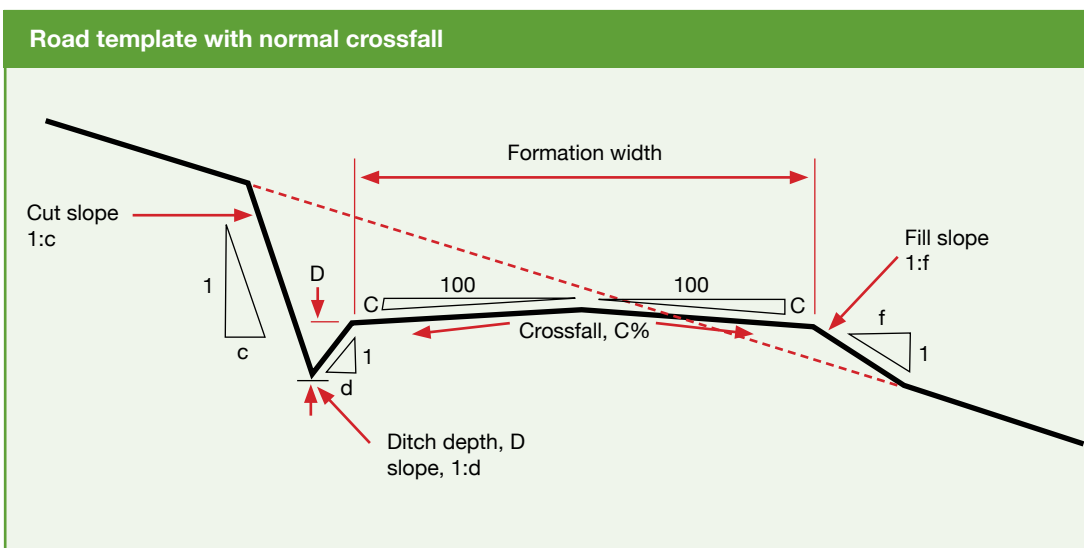

3. Planning for roads – continued

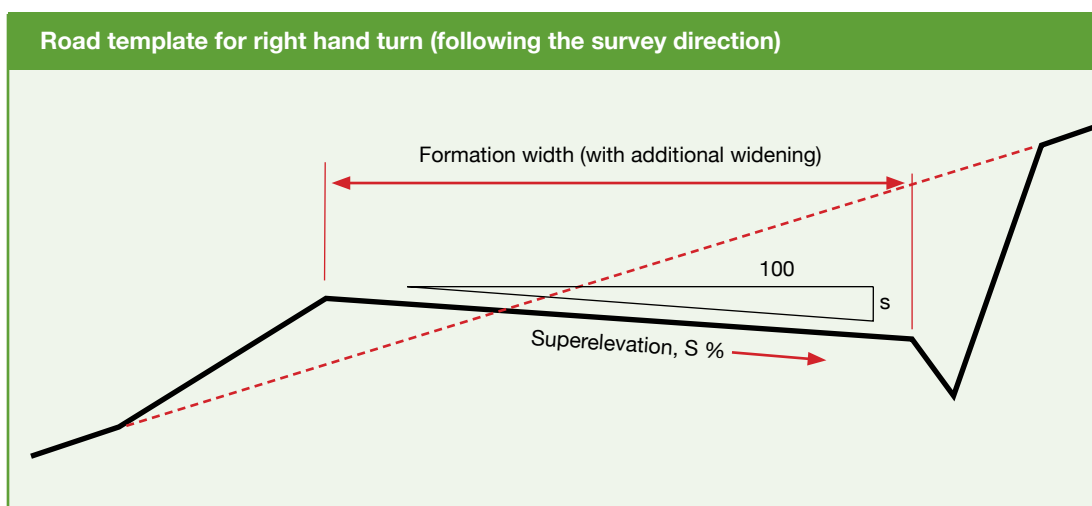
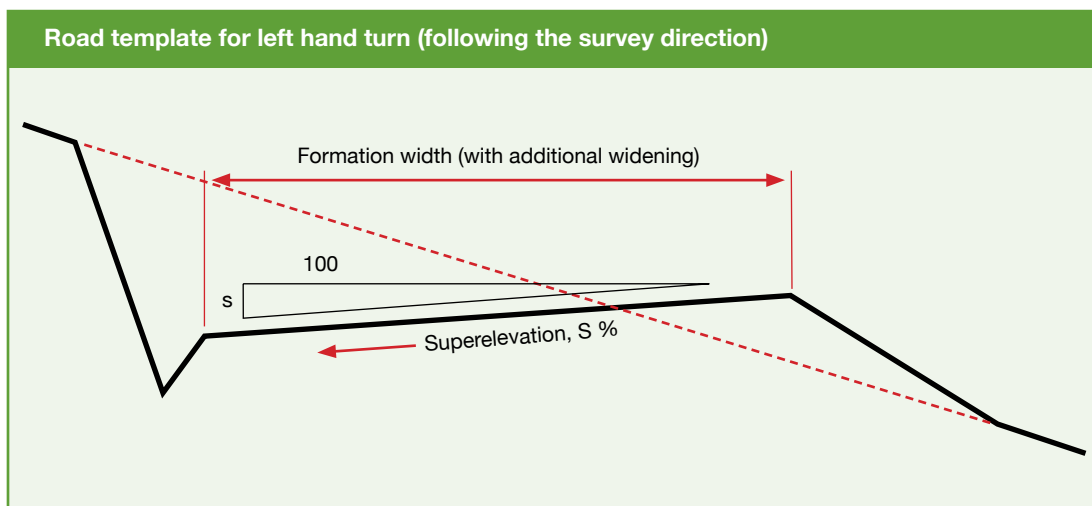

Standard road cross sections (templates) (Source: Walbridge, 1997)

- **Cut slope: 1: c:** The slope specified is less than or the same as the maximum stable slope which can be maintained. This is very dependent on soil type and local conditions. A good indicator is existing cut slopes on other well-established roads in similar soil types
- **Fill slope: 1: f:** The slope at which a fill can be constructed with reasonable confidence of stability. This is typically 1: 2 but can be as steep as 1: 1.5 in stable soils
- **Ditch: Depth (D)** is dependent on local conditions but is typically 0.4 m. Slope (1: d) is typically about 1:2
- **Formation width:** This is the full construction width from edge of ditch to edge of ditch, including any shoulder that may be provided beside the aggregate surfaced carriageway width
- **Super elevation, S %:** This is the slope of the whole road surface provided at curves, to oppose the sideways force on vehicles when cornering. For low speed forestry roads, super elevation is not usually used
- **Cross-fall, C %:** This is the cross slope applied on the road to assist with shedding water and should be applied to all roads.



3.13 Curve widening

Additional widening at curves may be required to cater for trailer off-tracking. Curve widening is necessary to provide for the passage of loaded trailer axles outside of the truck wheel path and prevent them from tracking into the ditch. Curve widening is especially important when truck configurations with long drawbars and long trailers are intended to use the road.

The amount of curve widening needed varies significantly depending on the truck configuration, corner radius and central angle (corner length). Since vehicles travel in both directions, half of the required curve widening should be added to the inside and half to the outside of the curve. A tapered road section should be provided to allow a transition both into and out of the corner.

Some existing roads designed for 44 tonne and standard 4 axle trailer units may no longer be appropriate for 50t Max and HPMV configurations. Additional curve widening may be required to accommodate these.

The charts on page 44 provide curve widening for two common vehicle configurations – a truck-trailer combination and a stinger-type logging truck. The charts are valid for the

Off-tracking on a curve

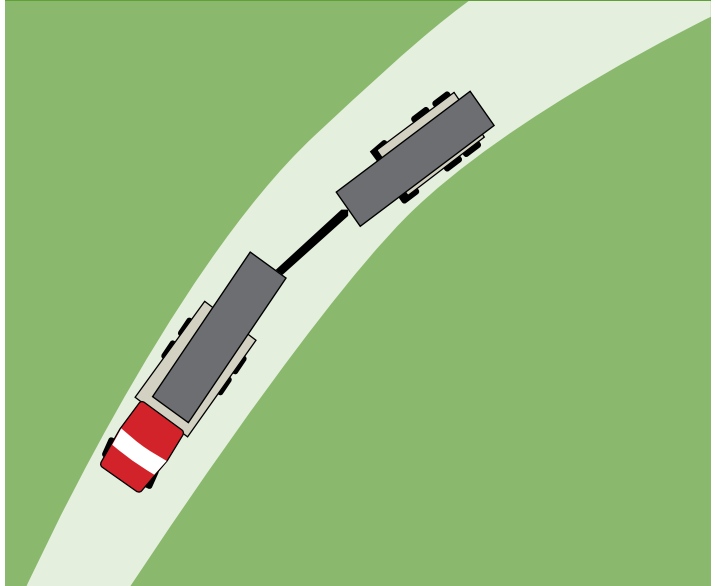

Trailer off-tracking on a curve. The magnitude of off-tracking depends on vehicle configuration, speed, corner radius and central angle (corner length)

specified vehicle dimensions and configurations only. Equations enabling calculation of curve widening for other truck configurations can be found in Chapter 3 of the 'FAO Watershed Management Field Manual' (FAO, 1990). www.fao.org/DOC REP/006/ T0165E/T0165E00.htm.

Curve widening

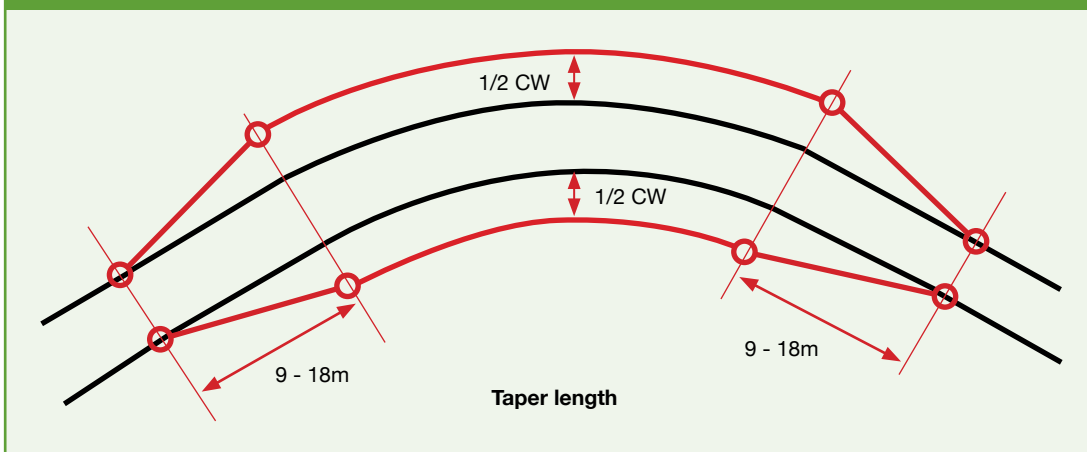

Curve widening is required on both sides of the curve (FAO Watershed Management Field Manual, www.fao.org)

3. Planning for roads – continued

Curve widening for truck/trailer combination

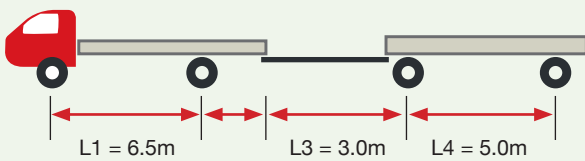
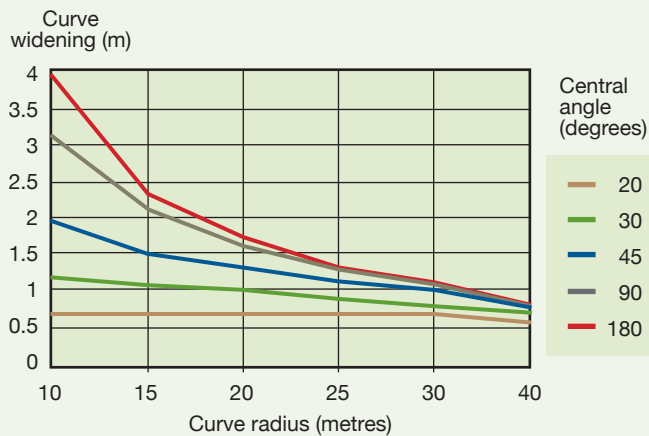

Curve widening for a typical truck/trailer configuration as a function of curve radius and central angle (www.fao.org)

Curve widening for logging truck (pole trailer)

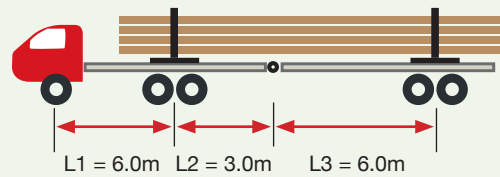
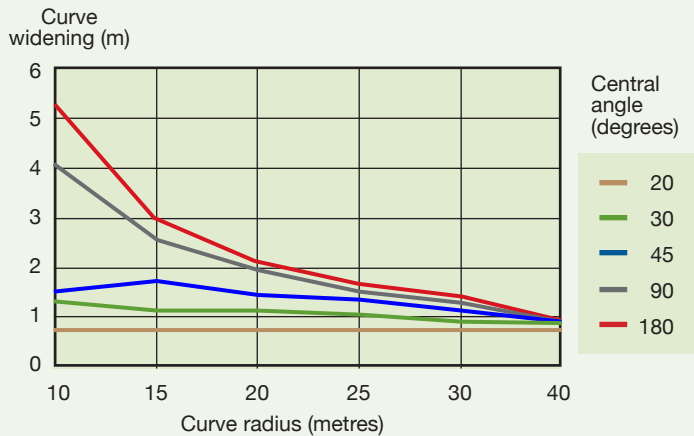

Curve widening for a typical pole trailer configuration as a function of curve radius and central angle (www.fao.org)

3.14 Horizontal alignment

A consistent alignment which provides no 'surprises' for the driver is more important than an absolute design speed standard in terms of safety. A practical approach needs to be taken for alignment because the lay of the land and the earthworks balance dictates what can be done. The coordination of horizontal and vertical geometry is important to ensure:

1. Safety and visibility
2. Good traffic flow
3. Acceptable level of visual impact of the road.

The diagram on page 45 shows how different curve radii and values of superelevation affect the design speed.

Alternatively, the minimum radius (R_{min}) required for a given design speed and superelevation can be derived from the following formula:

$$R_{min} = \frac{V^2}{127(n + f)}$$

Where:

- v = design speed in km/hr
- n = superelevation (m/m or %/100)
- f = coefficient of friction (use 0.08 for gravel roads).

The design speed (v) is determined by the desired road standard and the terrain.

The superelevation (n) is the slope of the road surface and is expressed as a decimal. A maximum of 0.0626 (6.26%) is appropriate for logging trucks. For speeds of less than 26 km/hr, superelevation is not needed and normal crossfall is used.

The minimum road curve radius for highway trucks (even at very low speeds) should not be less than 18 m. At a lower radius, the trailer inside tracking becomes very significant, and the truck minimum turning circle may not be able to be accommodated. For off-highway trucks and stem trucks the minimum curve radius will be greater than 18 m and can typically be 40 m.



Curve radius, superelevation and design speed relationship

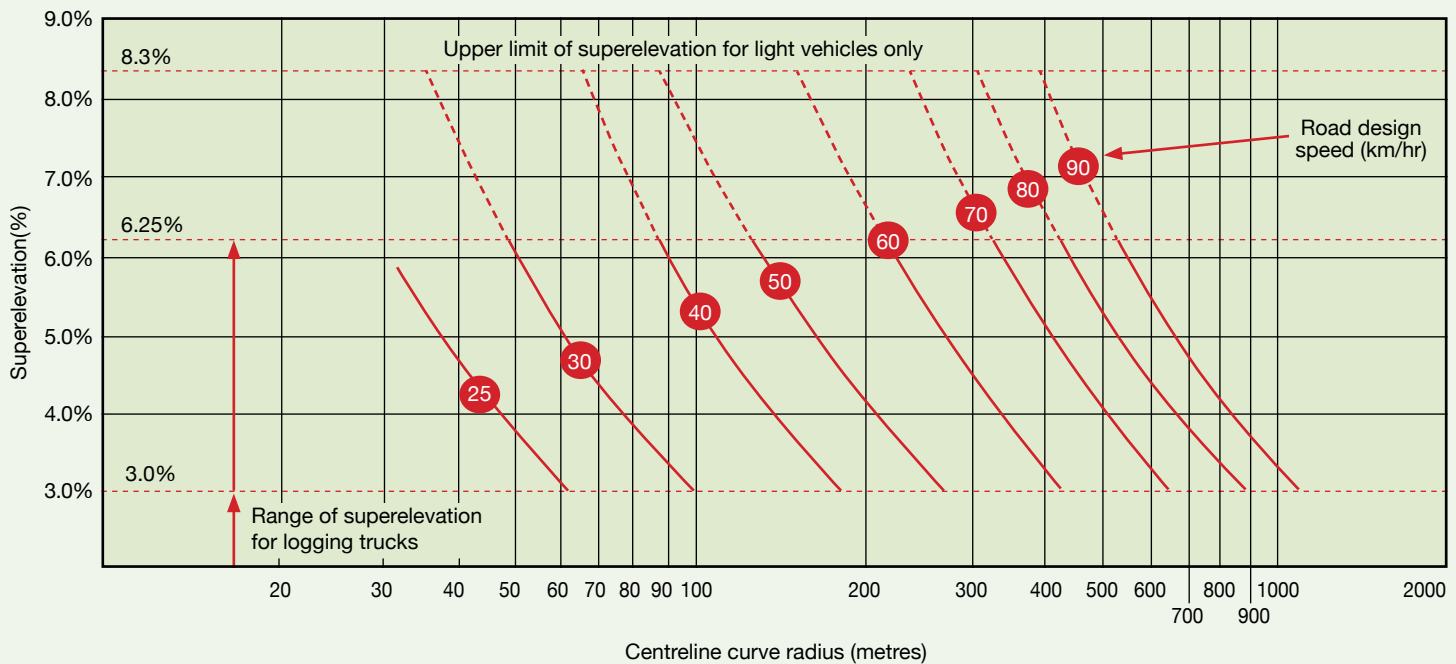

3.15 Vertical alignment

The table below indicates the recommended maximum grade for curves of different radius. These apply to New Zealand on-highway legal log trucks and are a guide only. Steeper grades on curves may result in loss of traction of the inside driver wheels because the effective road gradient on the inside of a small radius curve will be steeper than the centreline gradient. Also, steeper adverse loaded grades on curves may result in loss of traction of the outside driver

Recommended grade limits		
Curve radius (m)	Centreline maximum grade (highway trucks)	
	Adverse (%)	Favourable e (%)
16 to 26m	7%	10%
26 to 40m	8%	10%
40 to 60m	10%	11%
>60m	11%	12%

wheels because of the effect of the weight of the trailer on the turning truck. The trailer tends to pull the weight off the truck back towards the trailer and off the outside driver.

Sight distance should also be considered when designing and laying out the road; traffic must have adequate time to see oncoming vehicles or obstacles and safely stop. This is particularly important on one-lane roads where the driver does not have adequate space to take evasive action. In some instances, it may not be practical to improve sight distance so other methods of driver awareness or education needs to occur. For example, posting speed limit signs or simply warning of poor visibility. In all cases, vehicles travelling with minimal sight distance must travel at a speed that allows them to stop in half the visible sight distances, irrespective of what mitigation measures are used to avoid a collision.

Sight distance is limited by either the vertical (cannot see over a rise) or horizontal alignment (cannot see around the corner).

3. Planning for roads – continued

Sight distances are calculated from both alignments and the shorter of the two distances is the limiting factor.

Design sight distances must be maintained over the period of operational use of the road as required by Worksafe's *Approved Code of Practice for Safety and Health in Forest Operations*. The chart below indicates the sight distance for a crest vertical curve. If the sight distance is less than the required stopping distance, then either the design must be altered, or other provisions must be made to prevent an accident. It is common practice to manage a collision hazard on active harvesting roads, by ensuring all vehicles maintain radio communications with any moving vehicle, reporting position and direction of travel. Other mitigation measures may include having one-way circulation on roads or applying maximum speed limits.

If more detail is required, the *Unsealed Roads Manual Guidelines to Good Practice*, ARRB

Transport Research (2009) provides equations where sight distance can be calculated.

The following, in order of preference, are ways to improve vertical alignment and sight distance:

1. Re-design the vertical curve, that is, make the vertical curve length longer and/or reduce the grades
2. Widen the road to two lanes, and place 'keep left' signs. Note that this measure provides limited protection against obstacles on the road
3. Place a warning sign to reduce traffic speed, for example, 30 km/hr restriction.

The following, in order of preference, are ways to improve horizontal alignment and sight distance.

1. Re-design the horizontal curve, for example increase the curve radius
2. Clear the edge of road to increase the sight distance, for example, widen the cut bank, remove trees or vegetation

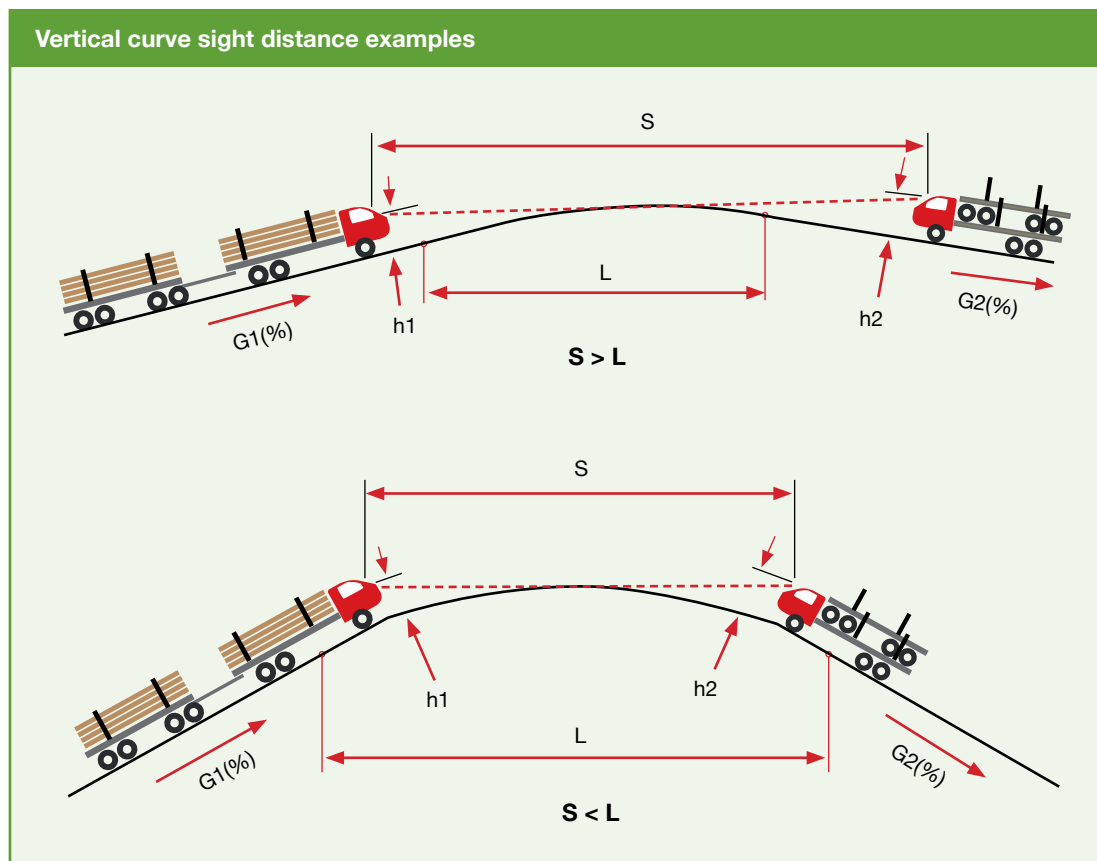



Sight distance on crest vertical curves ($h_1=1.5\text{m}$ & $h_2=0.2\text{m}$)

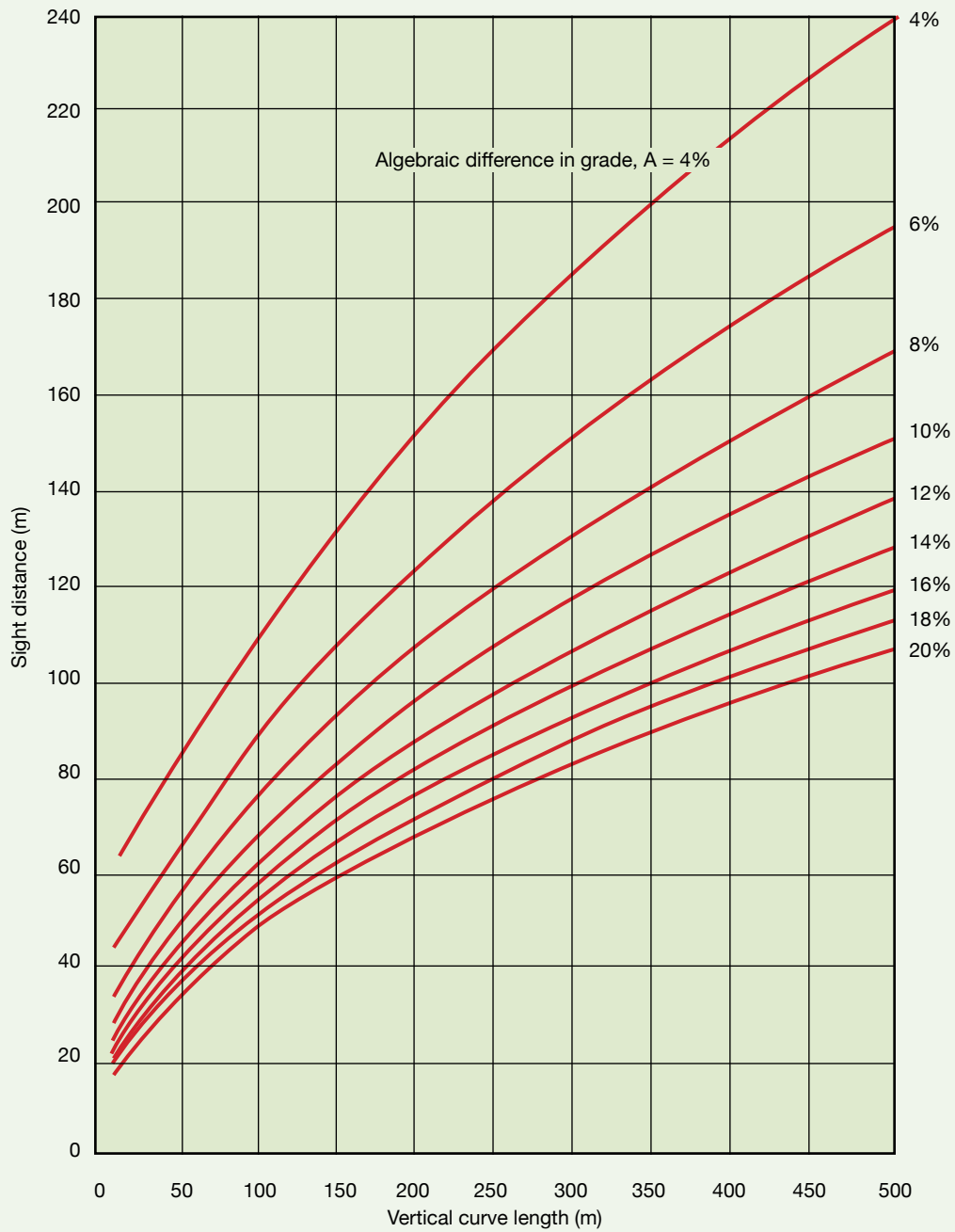

The above graph can be used to estimate the available sight distance (Source: Austroads 1993: Rural Road Design)

3. Planning for roads – continued

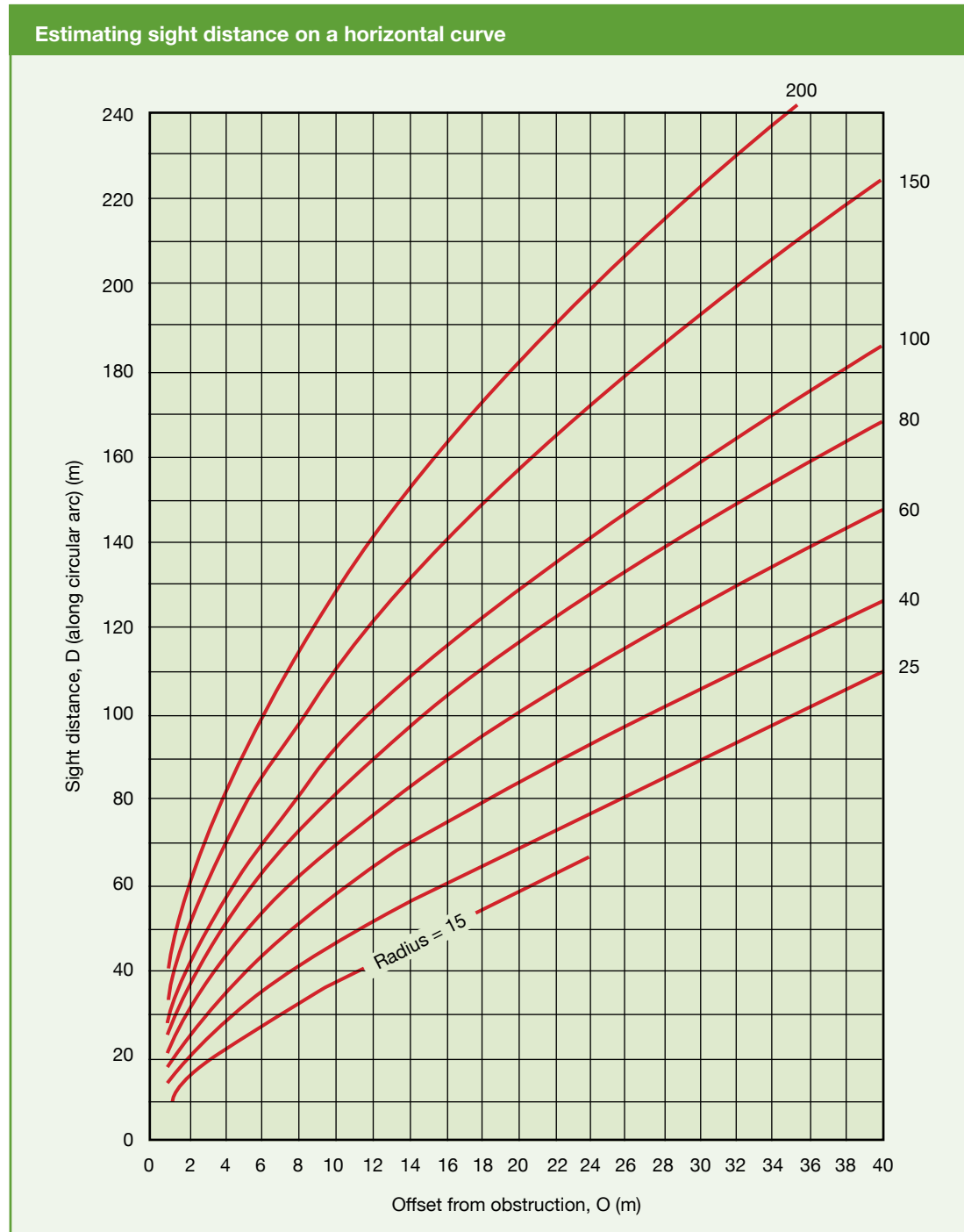

The chart above shows sight distance for horizontal alignment. Again, for more detailed calculations use the ARRB (2009) reference

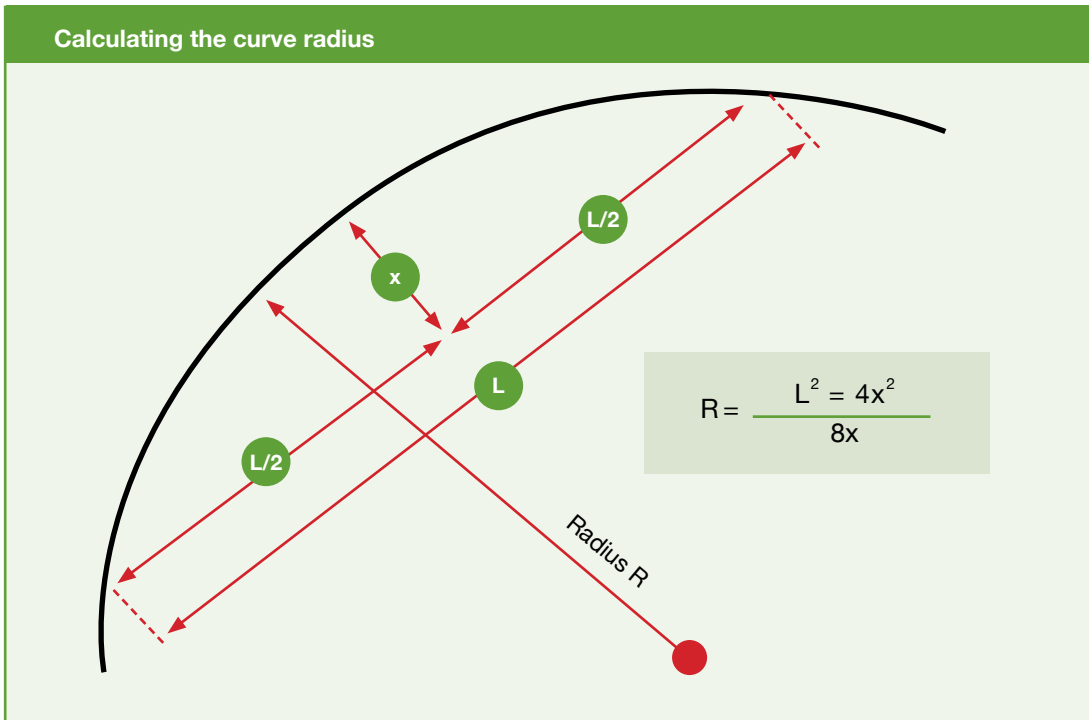

- Widen the road to two lanes and place 'keep left' signs. Note that this measure provides limited protection against obstacles on the road
- Place a warning sign to reduce traffic speed, for example, 30 km/hr restriction.

3.16 Calculating the safe stopping distance

The deceleration values are those recommended by Austroads (1993), and the reaction time is assumed to be 2.0 seconds. Using the charts on pages 47 and 48 and the formula below, the required stopping distance at various speeds are shown in the following table.

$$S = vt + \frac{v^2}{2a}$$

Where:

- S = stopping distance (m)
- v = initial velocity (m/s)
- t = reaction time (2.0 s)
- a = deceleration (m/s)

Stopping distances			
Initial speed (km/hr)	Deceleration (g=2.81m/s ²)	Stopping distance	Two-way traffic on one-lane roads (Stopping distance is doubled)
10	0.62g	6	13
20	0.62g	14	28
30	0.62g	23	47
40	0.62g	34	69
50	0.62g	47	93
60	0.48g	63	126
70	0.46g	82	163
80	0.43g	103	206
90	0.41g	128	266
100	0.39g	166	313

Stopping distance required to avoid a collision (deceleration values from Austroads, 1993)

3.17 Setting out the roadline

The road centreline, or the grade line, will be marked during the set-out stage, and after the roadline trees have been cleared, the road centreline may need to be re-established. To effectively transfer the full road design

3. Planning for roads – continued

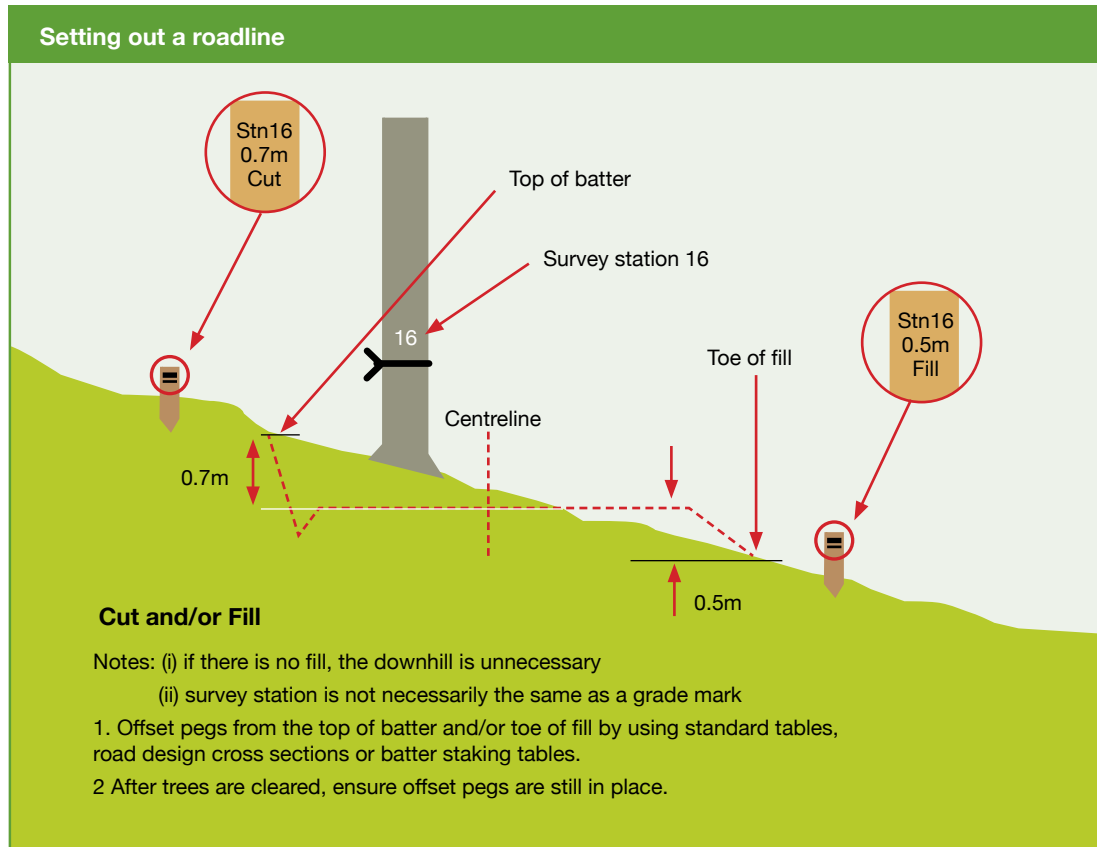

Source: Walbridge, 1997

information from the plan to the field, the grade line will need to be replaced with a centreline or use more sophisticated ways of providing guidance for the contractor. When a road has been designed using computer road design software, data is provided which enables the set-out to be installed by measuring off-sets from the original survey pegs. The format of this will vary depending on the software being used. The diagram above shows typical cross section outputs from RoadEng which indicate the position of the designed road relative to the survey station. Data sheets can be produced which provide offset slope distances for the

batter pegs from the survey station. This is used to provide set-out for construction.

Initially, pegs are offset from the uphill side from the top of batter and offset from the downhill side from the toe of fill. This allows a contractor to remove the trees from the roadline. After the trees have been removed, the pegs are checked to ensure that they are still in place. The station number, and depth of cut (from the top of batter) or depth of fill (from the toe of fill), together with offset information is written on the peg. Reference stakes outside of the clearing limits may also be used. These provide a distance and bearing to the centreline.



Chapter 4

Planning for landings



4. Planning for landings

Landings, yarder or hauler sites, skid sites and pads are all terms used to describe an area where logs are extracted and sorted, processed, loaded or stockpiled. Landings are used by ground-based or yarder logging, and production thinning or clear-fell operations. Landing construction generally requires significant earthworks. Poor landing location, design and management can have major consequences for safety, the environment, production, and quality and value recovery.

The NES-PF has many permitted activity rules for earthworks. This Manual, its associated *Operators Guide*, and the many FOA earthworks *Forest Practice Guides* have detailed information on environmentally acceptable earthworks construction practices.

4.1 Common landing layouts

The following are broad classes of landing layout. As already mentioned, their specific configuration will depend on many factors.

Drive-through landing

Drive-through landings use a loop road to allow trucks to enter the landing from one end, continue through the middle of the landing and leave via the other end. This reduces the area required for truck turning circles. Logs can be stacked on both sides of the road allowing the truck to be loaded from either side.

A problem with drive-through landings is that the road section passing through the landing



A cable yarding operation working on a landing



Aerial view, together with a schematic diagram (top right), of a drive-through landing

can rapidly become contaminated with mud and debris from the logging operation. Extraction, sorting and fleeting activities across the road can also lead to localised road failure. Drive-through landings are best suited for small settings harvested in drier times of the year.

Roadside landing

Roadside landings are very similar to drive-through landings. However, the landing is positioned to one side of the road only. The main disadvantage of this design is that trucks can be loaded from only one side. As stacks are harder to reach, it is most suitable when operating with a limited number of log sorts.

Spur road end landing

Spur road end landings are used at road ends. The landings often need to be constructed larger to provide a turning area for trucks. This takes space that could otherwise be used for

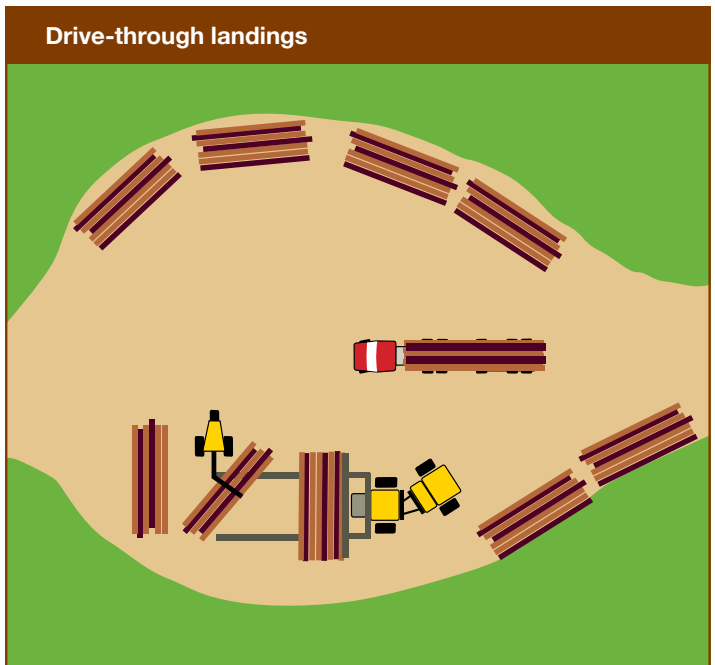

Roadside landings provide a clear separation between landing activities and the road, but can require more effort to reach logs stacks when loading out

log stacks or processing. Alternatively, when space is constrained, logging trucks can turn at a nearby widened road section or at a road junction and can back onto the landing.

4. Planning for landings – continued



Spur road landing

Split-level landing

Split-level landings are an option in steep country. The yarder is sited on the upper level, and the lower level is used as the landing and processing area. The advantages of split-level landings are that they require fewer earthworks, and their batter slopes can be shorter. This results in less visual impact and lower construction cost, plus may offer improved deflection for the yarder.

Two-stage operations

Two-stage operations use two (or more) landings. One is used to land logs, and the other is used to process, stack and load out. Two-stage landings have become common in steep hill country where a conventional sized skid is difficult to build. De-phasing the operation typically leads to a safer work site, reduced environmental effects, lower construction costs and harvesting productivity gains. For example, utilising a landing designed for the yarder and landing the stems means that the landing (often called a pad) can be located on a small site that provides favourable yarder coverage and deflection without major earthworks. The wood is then two-staged to a larger processing landing where there



Split-level landing with stems two-staged back to a processing site



Two-stage landing

is more room available to sort, stack and load. It also eliminates processing under yarder ropes. Two-stage operations require an additional machine' such as a skidder, forwarder or stems truck, to move the logs from the landing to the processing area.



4.2 Landing planning considerations

Review the planning considerations for constructing roads, as these will likely be applicable to landings too. The factors that are specific to landings or are worth reiterating when planning landing layout include:

- Topographical constraints, like steepness of terrain, geology and soils, which may constrain size, shape and access points
- Designing the landing and road location to ensure that the road adverse grade off the landing does not exceed 6% in the first 30 m. If it does, then road design and pavement accounts for truck egress. Design the favourable grade to be less than 12%
- Environmental constraints, including water control, slash location and diesel storage
- Types of machinery to be used on the landing. For example, yarder versus skidder, yarder type and configuration, rubber-tyre front-end loader versus excavator
- Processing area requirements. For example, conventional landing, two-stage landing, or at a central processing yard
- General storage requirements like number and size of log stacks and sorts
- Tree length. For example, at least two thirds of the stem/drag to be able to be landed safely and securely
- Loading out location and truck access
- Machinery production and likely bottle neck location
- Crew requirements including parking, storage container, smoko hut.

The selection of the final landing location may be the result of a compromise between the factors listed above. For example, steep, knife-edged ridges may require landings to be located back from the preferred site in order to build a landing of large enough size. Also, sometimes plans change so design criteria need to be flexible – especially since there may be two years or more between planning, construction and harvesting. For example, the landing may have been designed for a 26 m (85 ft) tower yarder

for deflection, but operational scheduling means that only a 21 m (70 ft) tower is available.

Be aware that deployment of a shorter tower may be interpreted by councils as a notifiable material change to a harvest plan under the NES-PF. This could result in an abatement notice being served if the NES-PF's requirement for log butt suspension, wherever practicable, cannot be maintained during yarding. This could lead to excessive ground disturbance, meaning that permitted activity Regulation 67 is breached.

Calculating landing earthworks is challenging unless you use road engineering design software. Where road egress off the landing is critical, it is essential to design the road and landing as part of the overall infrastructure design. In steep country where ridges are narrow, the constructed landing level could be way below the ridge crest. Unless the planner has anticipated the depth of cut correctly, an adverse road grade is likely to steepen. If the grade is already steep it will be constructed steeper. Operationally this may be fine in good weather but poor weather can lead to issues like having to do truck assists.



A 37t bulldozer (D8) and a 30t excavator constructing a new road and landing

4. Planning for landings – continued



Sometimes large earthworks are required for strategic landings but note the benching established to place the fill. Consider two-staging to reduce earthworks and cost

4.2.1 Landing size and shape

The efficiency of a harvesting operation is often very dependent on the configuration of the landing site. On average, landings are rectangular in shape and twice as long as wide, but landings for cable yarding operations are approximately 2.5 times as long as wide.

Design the landing shape to safely optimise the flow of logs through the work area, given the landform and other construction constraints. In many situations, the physical construction of the ideal landing is limited by site topography constraints. Therefore, the design of landings requires close liaison between the harvest planner, operations co-ordinators, and the logging and roading contractors.

Many serious work accidents and fatalities have been on landings. Some of these have been due to poor landing design and layout. It is essential that the planner understands their health and safety obligations when designing landings. Refer to WorkSafe's *Approved Code of Practice for Safety and Health in Forest Operations* (ACOP). Also, some forest company's health and safety manuals may have specific requirements too. WorkSafe requires that all landings shall be planned and constructed to allow safe operations to allow for:



When the situation is right, landings can be small yet maintain safety and productivity

- Stems, stockpiles and log stacks
- Safe areas
- Vehicle parking
- Fuel and chemical storage
- Load-out areas
- Where applicable, the yarder to be safely positioned, with at least two thirds of the stem/drag to be landed safely and securely
- Truck turn around.

Two typical design standards for landing size are 40 m x 60 m (= 2,400 m²) for small, or 40 m x 80 m (= 3,200 m²) for medium sized landings. However, a 2010 survey of landings indicated that the average landing size is now 3,900 m² – considerably larger than the design standards (FFR, 2010). A survey by Raymond (1987)



indicated they were 1,900 m², showing they have doubled in size over the last 20 years. Much of the increase in size, can be explained by the increased productivity of our typical harvest systems, as well as the need to work with much larger numbers of different log sorts. Both studies showed that the larger the operation, the higher the space requirements.

A basic equation that can be used to compare landing size is:

$$\text{Landing size (m}^2\text{)} = 390 + 3.5 \times \text{Daily prod (m}^3\text{/day)} + 173 \times \text{No. Log Sort.}$$

Other factors, such as machinery type, also affect landing size. For example, landings using front-end loaders instead of knuckle-boom loaders will need more space to operate. Landings may also 'grow' in size with the operation, especially ground-based logging, as contractors make more space to accommodate

log stacks. On average, a landing that has been used is 900 m² larger than a new landing, indicating that the contractors increase the size of landings during harvesting operations. This may be to accommodate additional log stacks, make space for new equipment, or simply side-casting material off the surface of the landing in the process of cleaning it up.

Reviewing recently harvested areas, including talking to operational staff and contractors, will also help identify what shape and size is effective and, as importantly, what aspects could be improved.

Safety is a prime consideration in layout.

4.2.2 Harvest residue (slash) management

Log processing can produce lots of slash and log waste, often referred to as harvest residue. It is estimated that on average 15% of the total volume will become harvest residue. The volume of slash generated, as well as the

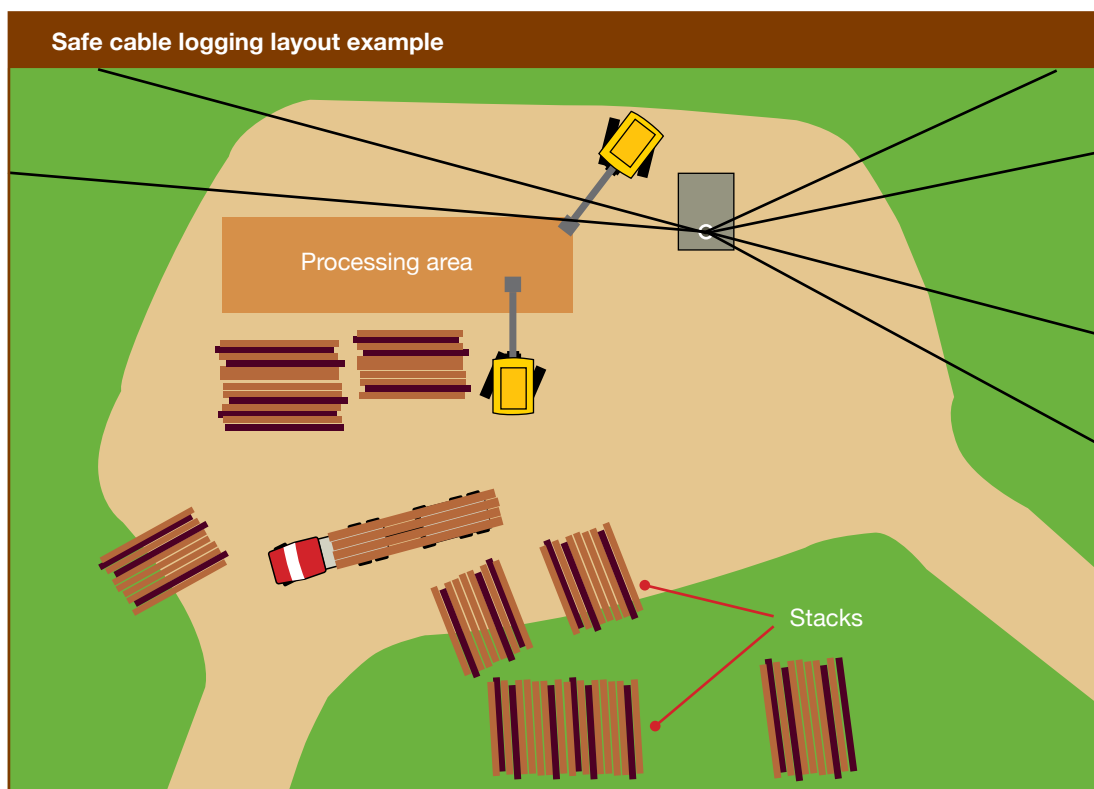

Cable logging landing with a processing area that does not interfere with loading out; safety is a prime consideration in layout, including if it is safe to work under ropes and locating chain shot zones

4. Planning for landings – continued



Plan for landing slash. Ensure the plan is followed otherwise the consequences can be major noncompliance with consent conditions or permitted activity standards

proportion that ends up on the landing, will depend on factors like the setting area, type of trees harvested, log grades specified, and the harvesting system used. It is essential that, if residues are not carted off-site, provision is made for disposal of slash in an appropriate place in the landing design. Slash must be located to avoid risk of mobilising into waterways, riparian areas, wetland or other sensitive sites, or where it could migrate off-site and effect adjacent neighbours and infrastructure.

Key planning considerations include:

- Ensure there is enough suitable area for slash, so it is not deposited in unsuitable locations. If not, locate a stable location to cart off-site
- Don't locate slash where it will load fill slopes that could lead to landing collapse. Make sure planning maps have clearly marked areas that are not acceptable to dump slash
- Identify areas where slash will be retrieved during post-harvest rehabilitation. Slash will rapidly go beyond the reach of the cleanup excavator if too much is pushed or placed there

- Manage water control around slash piles. Water that drains onto wrong places like through, or over large fills, will weaken and load the slope where the slash is located and increase the risk of fill failure
- Where possible, locate slash disposal sites that are less visible to public to reduce visual impact.

Planners should also consider opportunities to remove slash from landing as part of a biomass recovery operation. In some parts of the country this is a potential opportunity. Biomass will reduce environmental impacts from slash storage and also reduce the fire risk.

Burning is another tool that can effectively reduce the slash loading on landings. Burning can be challenging and risky unless it is managed carefully by experienced operational staff. Major forest fires have been accidentally started through burning slash on landings. Landing fires can take weeks to burn out.

The FOA *Forest Practice Guides* (FPGs) provide more detailed guidance on slash management.



Chapter 5

Road and landing construction



5. Road and landing construction

This chapter outlines road construction techniques and practices, and provides information on machinery types, machinery combinations, and the situations for which they are best suited.

Well-constructed roads require both teamwork and coordination as the project goes through the planning, layout and construction phases. Roothing planners need to talk to engineers, roading and harvesting supervisors, and contractors. Supervisors and contractors need to voice operational concerns. On steep, erosion prone hill country, earthworks need to be carefully managed. A skilled, efficient and resourceful team will identify and address potential issues before they arise.

For river crossings and water control measures including debris traps, see Chapters 6 and 7. For general information on traffic and hazard management, and road signage refer to *WorkSafe's Approved Code of Practice for Safety and Health in Forest Operations (ACOP)*. Where the ACOP specifically details road construction requirements these have been included in this Manual.

The diagram below describes some of the commonly used roading terms.



Well-constructed road with good salvage width and construction techniques

5.1 Soil and rock properties

The type of soil and rock that comprises the earthworks can greatly affect the ease of construction, the fill placement and compaction

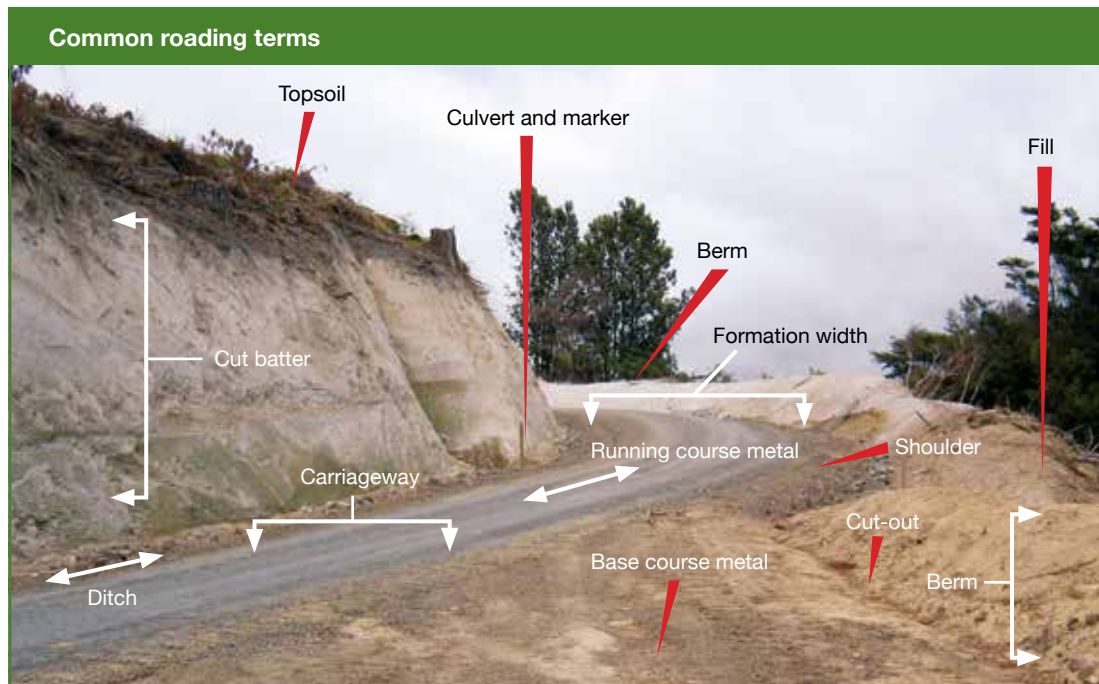

Figure showing common roading terms used for forest road construction



methods, the potential environmental effects of the operation and ultimately the cost of the job.

Determining soil and rock properties requires a technical background. The following link provides an overview of the detailed analysis required to assess basic properties www.ce.memphis.edu/4151/Documents/Field%20Analysis%20of%20Soils.pdf. A very useful reference is the two-page *Guideline for Field Classification and Description of Soils and Rock for Engineering Purposes*, New Zealand Geotechnical Society, December 2005 www.nzgs.org/library/field-description-of-soil-and-rock-field-sheet/.

Soil and rock come in many shapes and forms. The following provides basic descriptions of the broad classifications. One relatively easy aspect on which to categorise soils is by the size of the particles:

- Boulders – large rock segments (> 200 mm). They typically must be removed during road construction, however, in most situations, they make excellent material for retaining walls
- Cobbles – larger rock segments 60-200 mm. Unless they are integrated into a deep base course, they are typically too large to integrate

into the pavement. They move as trucks pass over them and create voids where water can get in. Cobbles are typically an ideal size for armouring and rip rap material

- Gravels – particles between 2-60 mm. They should make up the bulk of any improvement layer
- Sand – rock fragments of various sizes and shapes. These may be either rock fragments or single minerals
- Silt – very fine sand particles. Silt is less plastic and more permeable than clay, and displays ‘dilatant’ and ‘quick’ behaviour. Quick behaviour refers to the tendency of silt to liquefy when shaken or vibrated, while dilatancy refers to the tendency to undergo volume increase when its shape is changed (deformed)
- Clay – particles that are fundamentally different from silts. They are formed by chemical weathering and exhibit the properties of ‘cohesion’ and ‘plasticity’, which are not found in sand or gravel. Cohesion refers to the fact that the material sticks together, while plasticity is the property that allows the material to be deformed without volume change or rebound, and without cracking or crumbling. Plasticity can

Grain size criteria

TYPE	COARSE									FINE		ORGANIC
	Boulders	Cobbles	Gravel			Sand			Silt	Clay	Organic Soil	
			coarse	medium	fine	coarse	medium	fine				
Size Range (mm)	200	60	20	6	2	0.6	0.2	0.06	0.002			
Graphic Symbol												

PROPORTIONAL TERMS DEFINITION (COARSE SOILS)

Fraction	Term	% of Soil Mass	Example
Major	(...) [UPPER CASE]	≥ 50 [major constituent]	GRAVEL
Subordinate	(...) y [lower case]	20 – 50	Sandy
Minor	with some ... with minor ...	12 – 20 5 – 12	with some sand with minor sand
	with trace of (or slightly)...	< 5	with trace of sand (slightly sandy)

SOIL CLASSIFICATION

A section within the New Zealand Geotechnical Society's field classification guide

5. Road and landing construction – continued

be estimated in the field by rolling a sample in the hand to form a clay 'worm' that stays connected without splitting. Clay is also what makes a pavement impermeable to protect the base course from high moisture content and subsequent failure. The strongest roads will be built with an adequate amount of clay in the pavement.

Other soil properties include:

- Organic soil – a soil that has such a high organic content that it no longer behaves like a silt or clay. Organic soil typically has little to no strength, and will degrade over time. Soils containing small to moderate amounts of organic material still retain the properties of silts or clays
- Difficult soils – New Zealand soils that do not fit easily into the above classification. For example, volcanic ash.

Unless a soil has been extensively sieved, it will be a mixture of the components above. Most in-situ soils will be primarily a mixture of the smaller components – sand, silt and clay.

Soils are categorised as being uniform if they have a narrow range of particle size, whereas 'well graded' soils have a broad range of particle size. Sand, gravel or cobbles will not exhibit any bonding characteristic, and soils with an overall high percentage of these components will be

referred to as 'granular soil'. Conversely, soils with higher percentages of fines (defined as silt or clays) are referred to as 'cohesive' soils.

The following are basic ways to estimate particle size and soil properties in the field:

- Rub a small quantity of the soil between the palms of your hands and try to shake the material off by rubbing and patting your hands together. Sand grains will fall off, leaving your palms clean, and silt and clay will stick in the fine creases, leaving a 'dirty' appearance.
- Next try to roll the material into a 3-4 mm wide worm by rolling a sample in the hand to see if it stays connected without splitting. Easily rolled indicates medium to high plasticity, so it has a high clay content.
- Check for quick behaviour. A simple test of 'patting' a saturated soil sample in the hand can be undertaken to assess these properties and distinguish silt from clay. Roll a wet sample into a 20 mm ball and flatten it. Now shake or tap the hand to see if water rises. If so, it is a silt.

Rocks fall into three broad categories: Sedimentary, metamorphic and igneous (volcanic). Engineering properties cannot be inferred from rock names. Rock strength and the degree of weathering are important considerations for the forest engineer in



Left: The process of rolling a worm is a simple test for clay content. Right: The pat and tap test for silt



Left: While side casting is often the easiest way to build a road, the material pushed over the edge onto the slope is very susceptible to erosion and failure. Right: Tension cracks have developed on the landing. Over time it will allow water to infiltrate and cause the fill slope to slump. It is very important to correctly bench and compact fill material

determining pavement properties. Rock is described on a scale from extremely strong to extremely weak. There are many methods and scales for describing the weathering of rock masses.

An additional suggested reference is the *NZTA Standard Specification F/1 – Earthworks Construction* www.nzta.govt.nz/assets/resources/earthworks-const/docs/earthworks-const.pdf.

5.2 Managing adverse environmental effects

Earthworks can lead to adverse environmental effects, especially the risk of erosion and sedimentation. It is well documented that earthworks are a significant contributor to sedimentation from all forestry operations, including harvesting.

Three FOA publications describe good environmental practice – this Manual and the accompanying *Operators Guide*, and the *Forest Practice Guides*. Chapter 2, Regulations, Consents and Approvals, discusses the regulatory requirements that provide rules around forestry and its potential adverse environmental effects. These should be referenced when planning or managing earthworks.

The following are important practices:

- Earthworks should be planned, designed, supervised and constructed by appropriately trained personnel, employing engineering

expertise where prudent to do so

- Comply with all appropriate regulatory requirements, consent conditions and other authorities that relate to the particular earthworks activity
- Ensure important environmental values and sensitive areas are identified, and appropriate mitigation measures taken to protect these before an operation starts
- Ensure all construction personnel are aware of and understand the environmental issues, and the required mitigation measures
- Ensure equipment operation or earthworks activity operates behind a buffer zone, and does not migrate outside the intended zone into sensitive or protected areas such as rivers, wetlands, or archaeological sites
- Establish and maintain temporary drainage and sediment control during and after the earthworks construction period, until the site has stabilised
- Ensure erosion and sediment control structures are located and sized to the job
- Stabilise the site quickly; this may require vegetative and non-vegetative methods
- Construct stable earthworks fills, and avoid creation of unstable cut slopes
- Ensure handling of fuels, oils, construction material, waste and possible weed seed transfer is managed to minimise the risk of contamination of the site
- Avoid construction in wet conditions.

5. Road and landing construction – continued

5.3 Marking clearing widths

Getting the right roadline clearing width is important. Too little, and the road construction team does not have enough room to establish the cut and fill slopes. This may lead to trees being buried or more expensive construction. If the clearing widths are too wide, it may lead to windthrow or increase the harvest setting's logging rate. The clearing distance is the horizontal distance, so on steep slopes what appears to be a significant clearing width can ultimately be too narrow.

There are two ways of setting out the clearing width – an important first step in the road construction process. It sets the scene for the following operational steps, as it helps define the working area for the construction crew. The first and predominant way is to mark out the road centreline, or grade line, and specify a distance to each side to define the clearing width. The second is clearly defining the extent of the clearing width by pegging the outermost extent of it on either side at regular intervals.

The centreline marking approach is widely used in New Zealand. It relies on the principle of operator 'knows best'. This method generally works well, and is best suited if you are constructing in easy to moderate country and

have experienced crews and supervisors. The advantage is that planning and layout is quicker and easier.

Where unexpected soil material, drainage or stability issues are encountered, or construction problems arise, either improve operator skills through training or start pegging out. Use experienced earthworks operators in steep, challenging country where centreline and salvage limits are not marked. Ensure supervisors regularly visit the job. Sole reliance on a marked grade line can potentially lead to problems during construction. For example, the engineer could underestimate the location of the centreline in relation to the grade line, the road line salvage crew could take out too few or too many trees in the clearing width, and the extent of the earthworks could be under or overestimated.

The second approach – clearly defining the extent of the clearing width by pegging the outermost extent of it on either side at regular intervals – is carried out for roads that have a full design road plan (see Chapter 4), and the top of the cut and the bottom of the fill from the proposed road location can be identified. Another option, if using a modern mechanised felling plant, is to use the electronic tools available to set the boundary.



Left: Well-marked road clearing limits. Right: The clearing limits were not marked wide enough



5.3.1 Determining clearing widths for non-surveyed roads

In order to determine the extent of the road, the road centreline needs to be marked. From the centerline, the road profile can be estimated or marked out; this defines the upper and lower limits of the roadway. As a rule of thumb, allow at least 3 m beyond the upper and lower limits for contingency. This becomes the clearing width. Major construction issues result if too few trees are marked out. Allow more downslope clearing limits as the terrain steepens, and where benching is required.

There is no standard approach to marking clearing widths to help the roadline salvage crew remove the appropriate width of trees. Some companies mark the roadline width with the trees that are marked to remain, but some rely on the skill and experience of the crews, and the supervision of them, to do a good job.

Marking the boundary has several advantages – the planner determines the width; the contractor removes the minimum number of trees, and the operational control may not need to be as close. These advantages can reduce the cost of road line harvesting and road construction. However, marking out does take time and good crews quickly learn what is required if road line salvage limits are not marked. Another option, where available, is to use the electronic tools in the felling plant to set the boundary.

On gentle to rolling country, the centreline typically follows near to the grade line. On steep and bisected country, the grade



Re-establishing the grade line after road line salvage using taped branches as markers

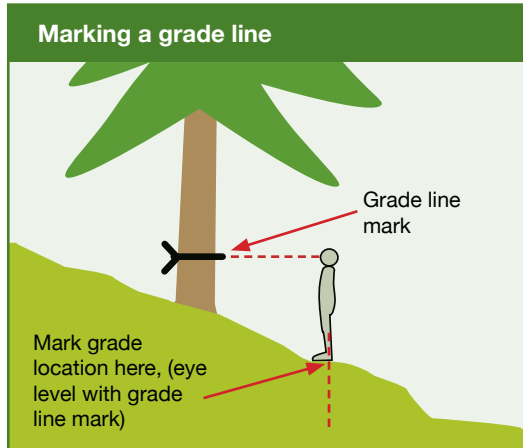

Source: Walbridge, 1997

line may not be representative of the road centreline at all. This is especially true in country with lots of small gullies and ridges due to the grade line not physically being able to follow the actual road alignment.

The grade line location is marked at the finished road level, and is not the same as the road centerline.

Estimating clearing widths for cut and fill cross sections

For some sections of a non-surveyed road, it may be prudent to peg out the extent of the cut and fill slopes. This will enable the machinery operator to better visualise the finished road and use the marker pegs to more effectively construct the road segment. The diagrams on page 66 show a typical cross-sectional layout, and the equation to calculate the width. Ideally, the engineer would use road design software to determine this, rather than the slow and less flexible manual approach and calculations.

Where:

A = Offset distance along natural ground on uphill or cut side in metres

B = Offset distance along natural ground on downhill or fill side in metres

U = Depth of cut from the top of batter in metres

T = Depth of fill from the toe of fill in metres

c = The cut slope in degrees. The appropriate value is dependent on the stable angle of repose for the cut slope material.

f = The fill slope in degrees. The appropriate

5. Road and landing construction – continued

A typical cross-section layout

Cut

$$U = \frac{\sin(180^\circ - c)}{\sin(c - s)} \times W_1 \sin(s)$$

$$A = \frac{\sin(180^\circ - c)}{\sin(c - s)} \times W_1$$

Fill

$$B = \frac{\sin(180^\circ - f)}{\sin(f - s)} \times W_2$$

$$T = \frac{\sin(180^\circ - f)}{\sin(f - s)} \times W_2 \sin(s)$$

value is dependent on the stable angle of repose for the fill slope material. The value selected for f cannot be less than or equal to the value for s, as the fill slope and side slope will not converge, creating an infinite fill slope

s = The side slope in degrees for the road cross section. This value is taken from survey data

W1 = The road formation width, in metres, that will be constructed on the cut bench. Forest roads constructed on steep side

slopes (angles greater than 20%) should have the majority of the road formation constructed on the cut bench to limit the risk of fill collapse under heavy vehicle loads

W2 = The road formation width, in metres, that will be constructed on the fill slope.

The total road width is W1 + W2.

Note: These equations need to be converted from degrees into radians to use in Excel. For example, variables c, s and f and the 180° constant all need to be converted to radians.

Large volumes of material need to be shifted when roads are constructed on steep side slopes. To limit the quantity of earthworks required in steep country, a steeper cut slope (C%) can be made. The following table shows the advantages and disadvantages of a steep cut slope.

Steep cut slope	
Advantages of steep cut bank	Disadvantages of steep cut bank
1. Less right-of-way	1. Difficult to revegetate
2. Less excavated material	2. Prone to ravel and ditch plugging
3. Less side cast	3. Risk of increased slumping
4. Shorter slope exposed to erosion	4. Increased risk of rotational failure



A very high batter with a steep cut slope. While this slope may be susceptible to some slumping and raveling over time, the alternative of cutting the slope back would result in a much greater road prism

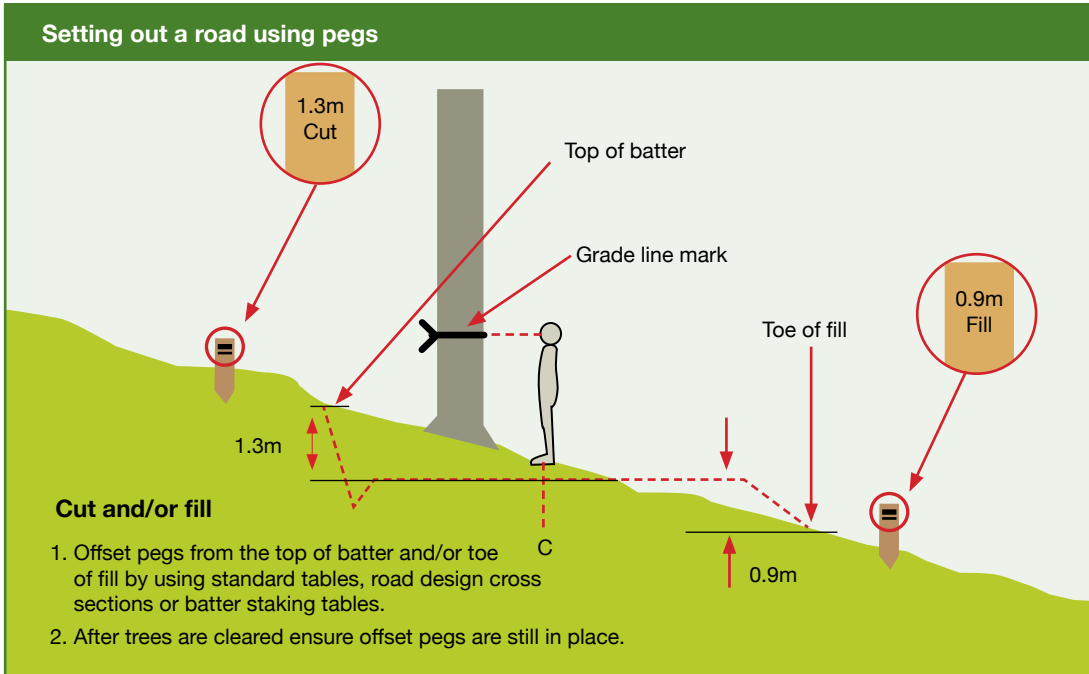

Source: Walbridge, 1997

Advantages and disadvantages of a steep cut slope

The top of the batter and the toe of fill can be located by measuring the ground slope in the field using a clinometer, and then measuring out the appropriate slope distance. Pegs are then used to mark these positions. See above.

Setting out a road section

The following examples show the setting out for a 6.6 m road cross section. The first, below, is on the gentle side of a slope, the second, on page 68, is on a slope that requires full bench construction. A

cut slope of 200% and a fill slope of 70% is used for these examples.

As the slope steepens and approaches the natural angle of repose for the fill, the road needs to be full bench constructed, as shown in the figure on page 68.

The equations to calculate the offsets and cut and fill depth can be used, together with the road width and slope angle assumptions, to develop a table that shows appropriate set-out data. The lookup table can then be used when setting out the road formation in the field. A

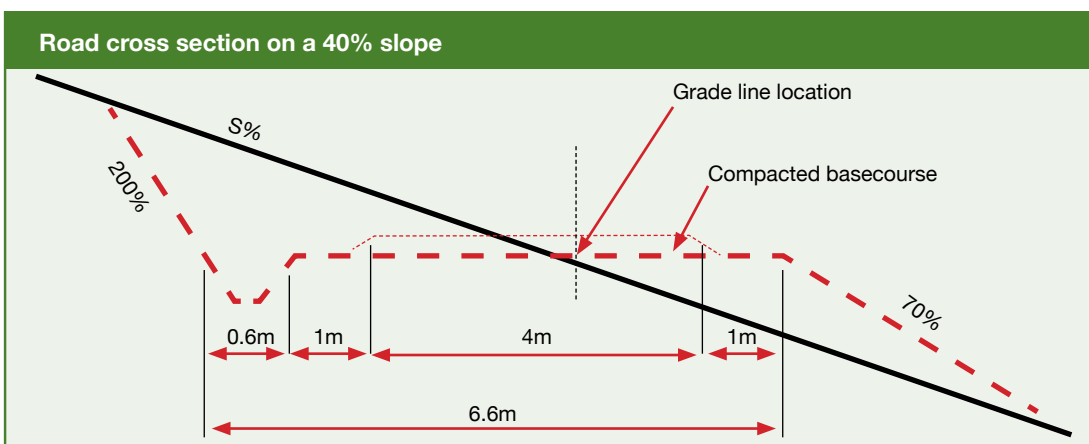

General set out of a 6.6 m road cross section with side slope < 40% (Source: Walbridge, 1997)

5. Road and landing construction – continued

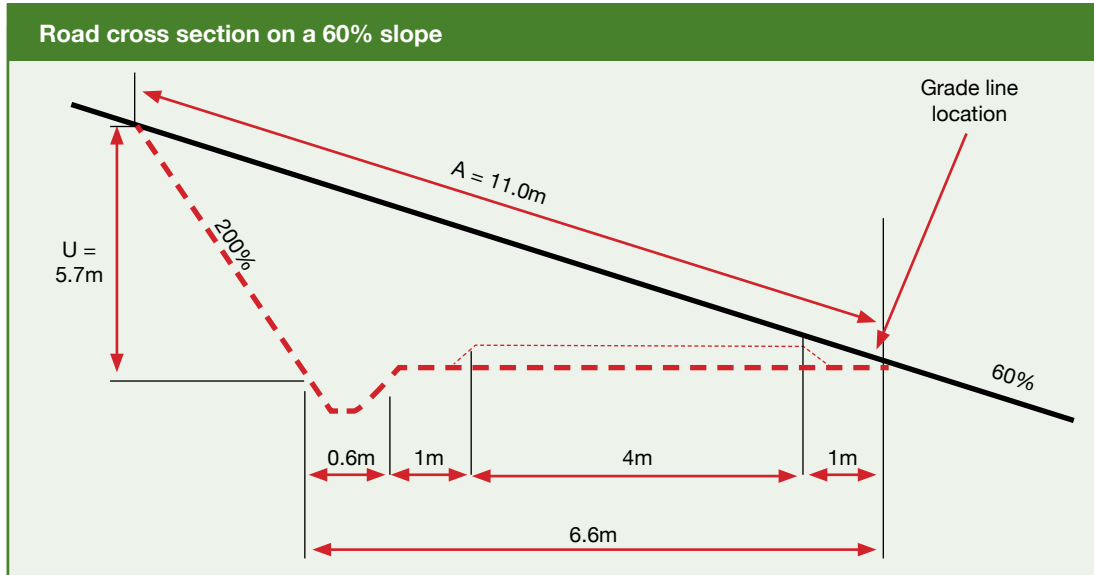

Set-out information for a 6.6 m road cross section with a side slope of 60% (Source: Walbridge, 1997)

table for this example is shown below.

Note that the table is not appropriate for setting out block cuttings or all fill cross sections. These require different calculations, and road design software packages are a better option to determine these clearing widths.

Offset for formation width (W) 6.6m Cut slope = 200% Fill slope = 70				
Slope S%	Offset cut A	Depth cut U	Offset fill B	Depth fill T
10%	3.8	0.4	3.7	0.4
20%	4.2	0.8	4.2	0.8
30%	4.7	1.3	5.1	1.5
40%	5.4	2	7.7	2.4
50%	9.8	4.4	0.0	0.0
60%	11	5.7	0.0	0.0
70%	12.4	7.1	0.0	0.0
80%	14.1	8.8	0.0	0.0
90%	17.1	10.8	0.0	0.0
100%	18.7	13.2	0.0	0.0
110%	21.8	17.1	0.0	0.0
120%	25.8	19.8	0.0	0.0

Set-out data for a cut and fill formation width of 6.6 metres

5.3.2 Determining clearing widths for surveyed roads

The previous section provided tools that help estimate the extent of cuts and fills so that an acceptable clearing width could be calculated. For roads that have been surveyed and geometrically designed, the set-out widths and the extent of the earthworks have already been determined. This leaves pegging the road boundary at each of the survey points.

The logging crew should be instructed to remove all the trees contained within the pegs. After the trees have been removed the pegs should be checked to ensure they are still in place. The pegs determine the width for the bulldozer or excavator to clear all organic matter.

>> See diagrams page 69

5.4 Roadline salvage

A logging crew will need to remove trees before the engineering contractor can start the first step in building the road or landing – clearing and stripping. Determining the width of the salvage has been discussed in the above sections. It is critical that the roadline salvage width provides enough room to undertake these operations effectively. Since clearing and stripping must be carried out in advance of earthworks it is important that enough trees have been removed prior to the harvesting crew

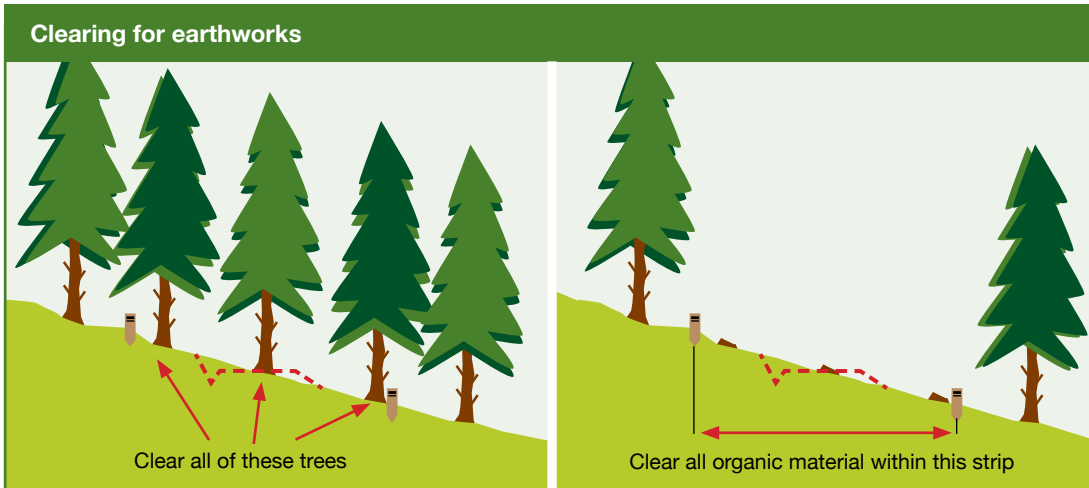

5.3.2 – Left: Trees that are to be cleared for earthworks. Right: The width to be cleared of all organic material for earthworks (Source: Walbridge, 1997)



The roadline salvage width is wide enough to form the road

leaving the site. Ideally, a site inspection should be carried out to confirm that the clearance widths are enough to construct the road or landing effectively.

Safety and environmental impacts must be considered, with care taken to not create or leave hazards that will affect future operations. Hazards arising from roadline salvage and stripping operations include:

- Poor placement of tree stumps on steep slopes, where they may be dislodged by future tree felling and extraction operations
- Leaving trees standing above landing sites or operational areas. These may present windfall risk to road users and harvesting workers.

5.5 Daylighting

Daylighting is the process of removing trees on either side of the road to allow sunlight onto the road. It may occur as part of the roadline salvage, where additional trees are extracted beyond what is required for construction, or on existing roads prior to harvest. Daylighting assists drying which will result in a firmer road and reduce rutting.

The daylight clearing width is very dependent on the position or aspect of the road. Daylighting is not required for roads constructed on true bearings clockwise between 305° and 055° because the sun will shine directly down the roadway, even on the shortest day of the year. Furthermore, there is little point in clearing trees

5. Road and landing construction – continued

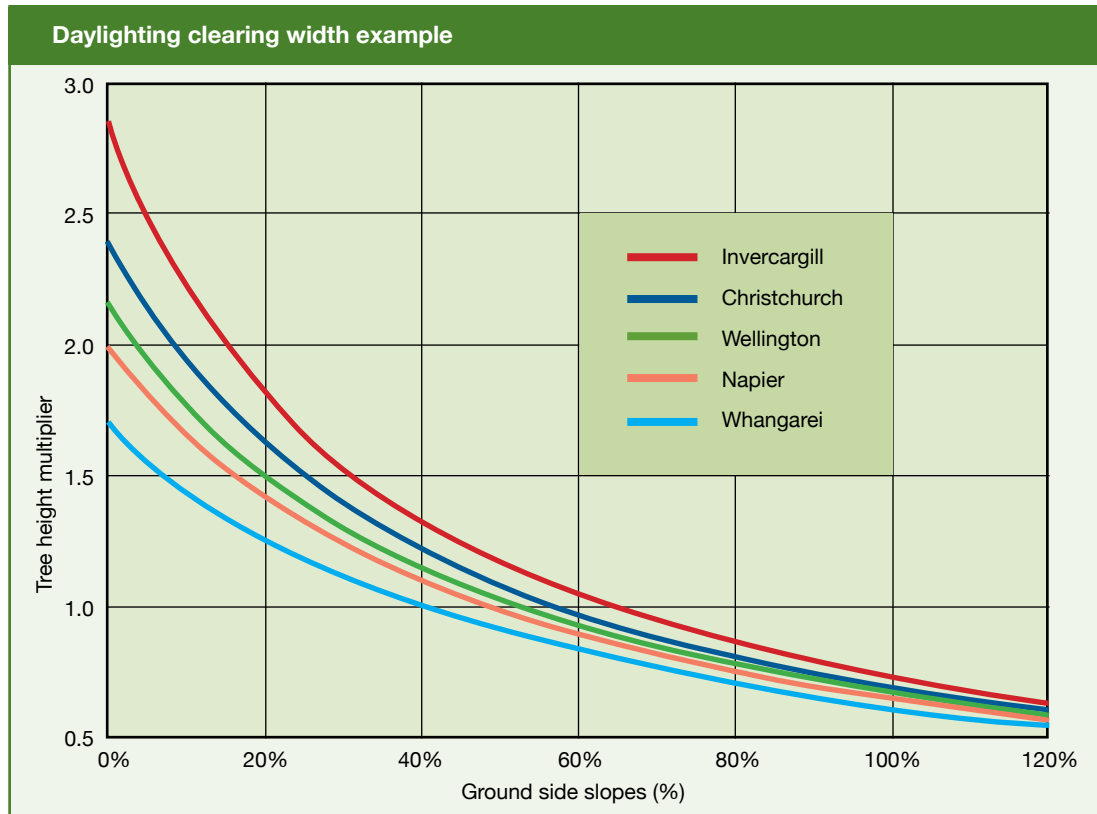

Daylighting clearing width required for one hour of daylight to reach the road on the shortest day of the year

20 m either side of the road if the sun will not reach the road in the middle of winter. It may be more beneficial to remove the north-facing trees and leave the south-facing trees standing. The mid-winter sun is then more likely to dry the road. Roads on steep terrain should, wherever possible, be constructed on north-facing slopes only, as the sun will generally not reach the road on a south facing slope.

The daylighting clearing width should be kept as small as possible, to ensure that the maximum productive area remains and, in some locations, to reduce the potential for windthrow. The figure on page 71 can be used to estimate the amount of clearing width required, assuming that at least one hour of sunlight must reach the road on the shortest day of the year. Note that the required clearance width is dependent on latitude and side slope.

>> See diagram page 71

5.6 Road formation

This section covers common road formation practices. It begins with clearing and stripping organic matter and vegetation, then discusses



Above: Balancing cuts and fills help minimise the overall earthworks required to construct a forest road
Below: Landings can generate large volumes of earthworks. Benching is essential in anything other than the easiest country to help stabilise the fill



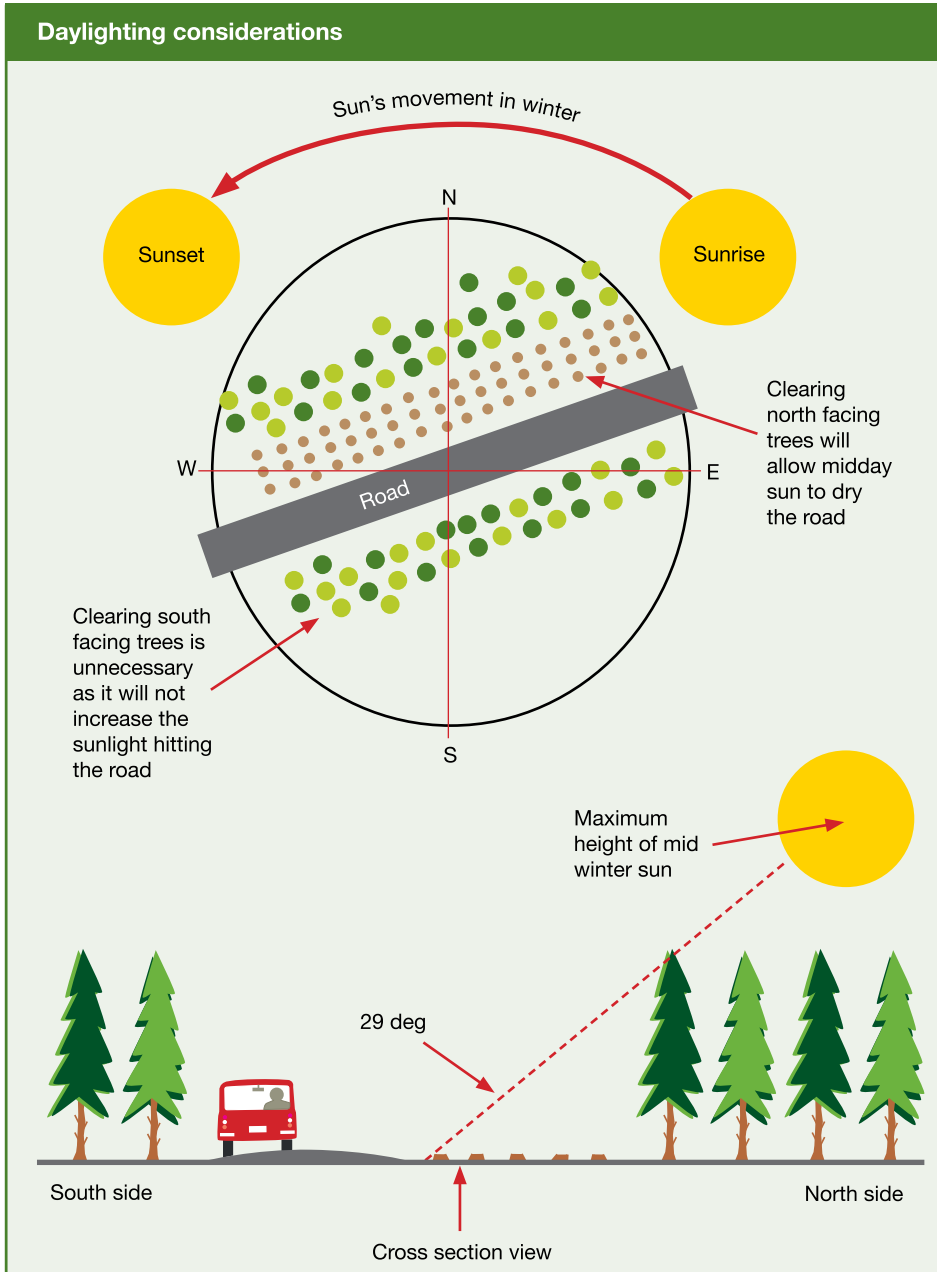

5.5 – Position of mid-winter sun and the effect of cutting north-facing trees for daylighting

bulk earthwork construction techniques for road construction. These are side cast, cut and bench and end-haul construction. Some road segments will require solely fill, others cut, and the majority balanced cut and fill works. There is a continuum between a road fully constructed on fill material to one that is entirely cut out of the hillside (benched) where all material has been carted off-site (end-hauled).

excavated material can be side cast and the road carriageway built partially on the fill. In moderate hill country, side casting is a risk for slope failure. The excavated material needs to be stable, and to help ensure this, a bench should be constructed below the road to contain it. On extremely steep or unstable areas, benching may become unacceptable, so the material is excavated and trucked away (end-hauled).

For many forestry roading applications, the formation methods fall somewhere between these extremes. Most earthworks are about how to balance cut and fill material in the best cost effective and environmental way. For example, on steeper slopes, a combination of cut and benched fill and end-haul should be considered. This can provide a practical and cost-effective solution.

Skill and expertise in identifying what approach to take in a given situation is essential. The approach varies depending on an array of on-site factors and social and environmental considerations. For example, topography, rainfall, soil, geology and the risk associated with these attributes help determine the approach.

One of the big issues with construction is what to do with the excavated material so that it is stable. On flat or rolling country this may not be a problem, as

5. Road and landing construction – continued

Another risk mitigation measure is to decommission non-essential roads after harvest where there is the possibility of off-site mobilisation of earthwork material. The fill material can be pulled back by excavator onto the road carriageway. The aim of the road rehabilitation is to reduce the likelihood of the fill slope failing and leading to sedimentation. Compaction, which is a critical construction step to stabilise fills, is discussed in detail in Chapter 6.

The NES-PF regulations have specific requirements for most aspects of earthworks. These are located throughout the regulations so make sure these are understood. Earthworks are an NES-PF activity, but general and ancillary rules also apply to aspects of road and landing construction. The NES-PF has earthworks threshold tests. This could include the erosion susceptibility classification (ESC), measurable limits like volume or area of earthworks, or secondary thresholds like sediment, fish spawning or setbacks in the worksite. Activities where you cannot meet the permitted rules will need consents. It is a fundamental aspect of forest engineering to understand the rules you need to work with to get the job done well.

Document and take photos of the location and construction of earthworks as they progress. For example, preparatory work like benching that is important to the integrity of the job but is hidden in the final formation.

5.6.1 Clearing and stripping

Clearing and stripping is the process of removing woody debris, organic soil and other unsuitable material – like surface vegetation of grass and scrub – before forming the road or landing. The reason why this material is removed is that organic material – such as tree stumps and roots, slash and branches – and topsoil are unable to be compacted. It decays over time and can be a point of water entry, resulting in weak and unstable fills that may collapse. Borrow pits and overburden dumps should also be cleared and stripped of vegetation and organic material.

Choose the right machinery size and combination for the terrain, stump size and

soil type. Excavator/dozer combinations can work best. Place stumps and debris in a stable location where they will not interfere or cause safety issues for other forestry operations, or have adverse environmental effects. For example, put on flat stable ground or a secure bench or beyond the toe of fills. Keep stripped material away from water bodies or any restricted areas. Where there is no suitable placement option, cart to a safe disposal site.

Ensure the roadline salvage strip is wide enough and safe to construct the road or landing,



An excavator and dozer clearing and stripping



Stumps left resting on a hill slope amongst standing trees are a significant hazard to tree fallers and breaker outs



Stumps have been placed on a bench, which is a safe location and one that will not cause environmental issues

and unencumbered by the surrounding trees. Earthworks should not commence if insufficient trees have been cleared, and there is a risk that the cut and fill batters will encroach into standing trees. If not wide enough remove or get more trees removed.

The NES-PF has rules around the maximum amount of wood and organic matter in the fill. A resource consent is required if there is more than 5% by volume.

5.6.2 Bulk earthworks – cut and side cast construction

The cut and side cast method is used for most forest road construction in flat to rolling terrain. Some, or all, of the excavated material is placed as fill onto the down-hill slope. It is important to assess structural requirements of the fill during the planning phase to determine if side cast is suitable. Uncompacted fill may not support heavy logging traffic and collapse under loading.

There can be increased environmental risk if this method is not used in the right location. Loose uncompacted fill is prone to erosion, and can create sediment issues if the road and landing water control is not well managed. Cut and side cast should only be used where there is no risk of sediment being deposited in a water body. For example, do not use above a perennial river regardless of slope. Stabilise or

Cut and fill side cast construction

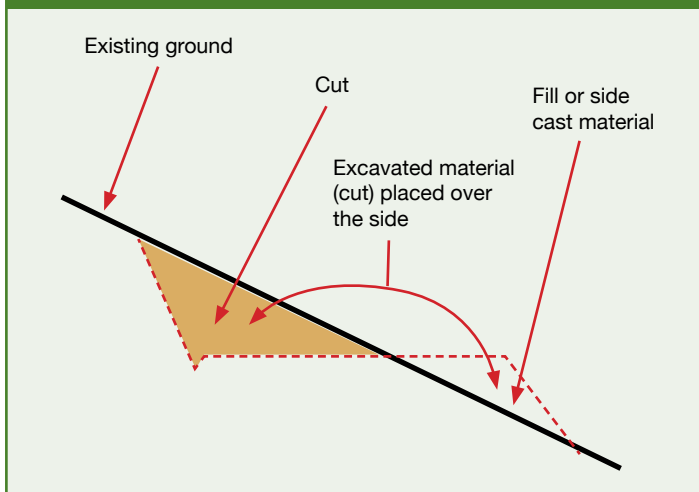

Cut and side cast construction

vegetate side cast material immediately after construction to mitigate ongoing erosion and sedimentation risks.

5.6.3 Bulk earthworks – cut and bench fill construction

Cut and bench fill construction is a common method for constructing roads on moderate to steep hill country up to about 35 degrees, where fill side cast onto the natural slope cannot be retained in a stable state.

On moderate to steep slopes, a level bench (or multiple benches) should be constructed to provide the base for structural fill. The bench(es) need to be designed to balance cut and fill volumes, and have an appropriate batter slope;

5. Road and landing construction – continued

the finished road formation must meet width and safety specifications. At its simplest, this involves constructing a pilot roadway or track, on grade, but below the formation height, to create the bench. This keys in the compacted fill to the slope and provides a level surface on which layers of fill can be compacted.

Benches should be constructed wide enough for the safe and effective operation of compaction equipment. A typical cross section confirming cut and fill batter heights and slopes should be developed during the planning and design phase. Where it is anticipated that subsurface water will be encountered within the bench formations, special provision should be made for the installation of subsoil drainage.

Not all slopes are suitable for cut and bench construction, so the initial road location assessment and design should assess whether the slope is suitable for this type of construction. Cut and bench construction is only effective where the fill batter can safely be contained or hold at a slope steeper than the natural ground slope. Therefore, it is not suitable on slopes that are too steep for side cast and/or where side cast formation is required to support

logging traffic so needs compaction.

With cut to fill construction, the fill will typically be part of the trafficked road formation (carriageway) and therefore needs to be structurally competent. It is good practice to compact, not track roll road fill. The fill should be spread and compacted in layers of uniform quality and thickness, parallel to the camber and grade for the full width of the cross section. The thickness of each layer should be limited to ensure that the specified compaction is achieved for the full depth of each layer. Refer to Chapter 6 for more information on this requirement.

On steep slopes, fill batters formed using cut and bench construction can produce significant areas of exposed soil. Bare earth should be stabilised or vegetated immediately after construction. Surface water controls need be established above the slope to direct storm

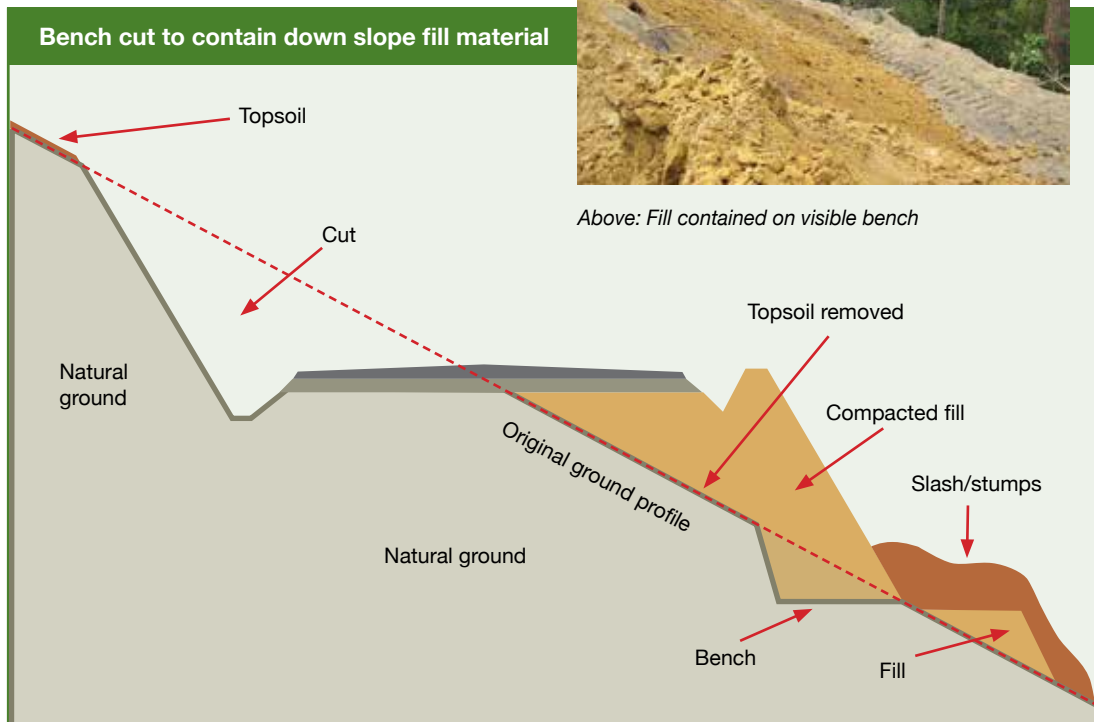

Above: Fill contained on visible bench



Examples of poor practice. Roads above rivers or waterways need careful planning and operational management

water runoff away from the fill to prevent scour and rill erosion, and fill saturation and slumping. Downstream sediment controls should be installed to contain sediment generated from the fill batter and prevent discharge to a water body.

The recommended fill slope for most soils is 1:5 H to 1.0 V (33 degrees). Specialist advice should be sought if constructing fill slopes greater than this, on steep slopes.

5.6.4 Bulk earthworks – end-hauling (full bench) construction

Full bench or construction with no fill is necessary where slopes are too steep to contain fill or where, for example, there are unacceptable consequences of a fill failure. This means the fill needs to be end-hauled to a safe containment area. The road is literally constructed on solid in-situ material. On slopes greater than 35 degrees, end-hauling is a NES-PF requirement. Also, it is not possible to compact side cast material to an appropriate fill batter slope, whether benched or not. If the fill slope is either too steep for the material involved, or if it cannot be compacted, the integrity of the road is compromised. As well as being unstable, uncompacted fill slopes have insufficient strength to support vehicle wheel loads. There can be substantial adverse environmental impacts in this situation.

End-hauling involves removal of the entire excavated material to a disposal area. End-haul road construction typically cost several times the

cost of side cast construction. To minimise the cost of end-haul construction, it is important to optimise the type and quantity of equipment as well as minimise the cartage distance to dump sites.

Full bench construction generates large volumes of material that needs to be disposed of. It is essential that dump sites are carefully located and treated as fill zones. Ideal locations for dump sites include shallow basins and areas of flat to gentle contour that are away from water bodies, and for operational efficiency, as close as possible to the work site. Avoid slip zones and visible earthflows, and areas above sensitive receiving environments. The fill area

End-haul (full bench) construction to eliminate fill

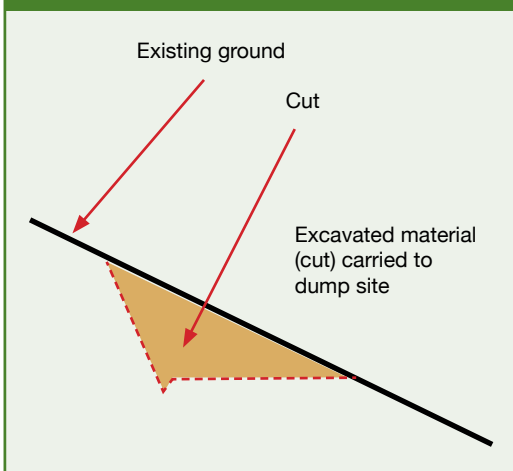

5. Road and landing construction – continued

should be cleared and stripped of vegetation and logging debris prior to the placement of fill. Erosion and sediment controls also need to be established to prevent/contain sedimentation. The long-term stability of the fill must be considered and, where necessary, fill should be placed and compacted in lifts to prevent slumping. The fill should be contoured and revegetated after construction.

In some circumstances, end-haul construction may not be appropriate. For example, in unstable rock, especially soft sedimentary with unfavourable bedding planes, or deep soft clay soils, such as lacustrine or marine soils where it may induce rotational failures. Seek specialist advice if needed.

The layout of haul roads can be an oversight. However, it is important that they are designed, constructed and maintained to support the safe passage of dump trucks for the duration of the construction operation.

End-haul construction typically requires an excavator to form the road, and trucks to cart the excavated material to the dump site, or where fill is necessary for other construction

areas. Each bucket of excavated material is loaded directly onto a truck for cartage and placement in the fill designated area.

There are two methods of end-haul road construction – the ‘one pass’ and the ‘two pass’. With the one-pass method, an excavator clears the trees and stumps, and forms the road in one pass. Every bucket load of material is loaded directly onto a truck for transportation to a disposal site.

This method is suited to the construction of narrow one-lane roads in very steep country. An additional benefit is less risk of sediment entering rivers than with other methods.

End-haul road construction methods

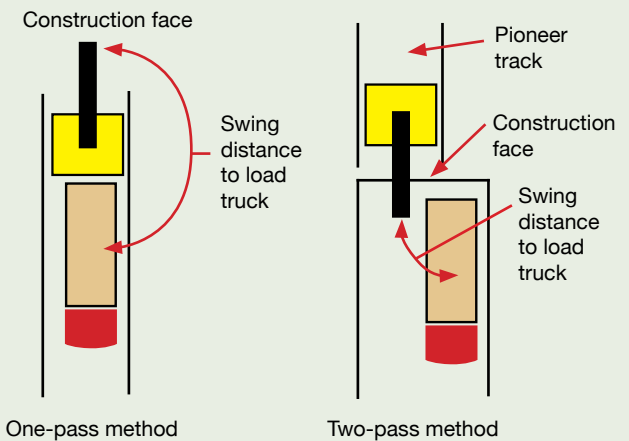

End-haul road construction

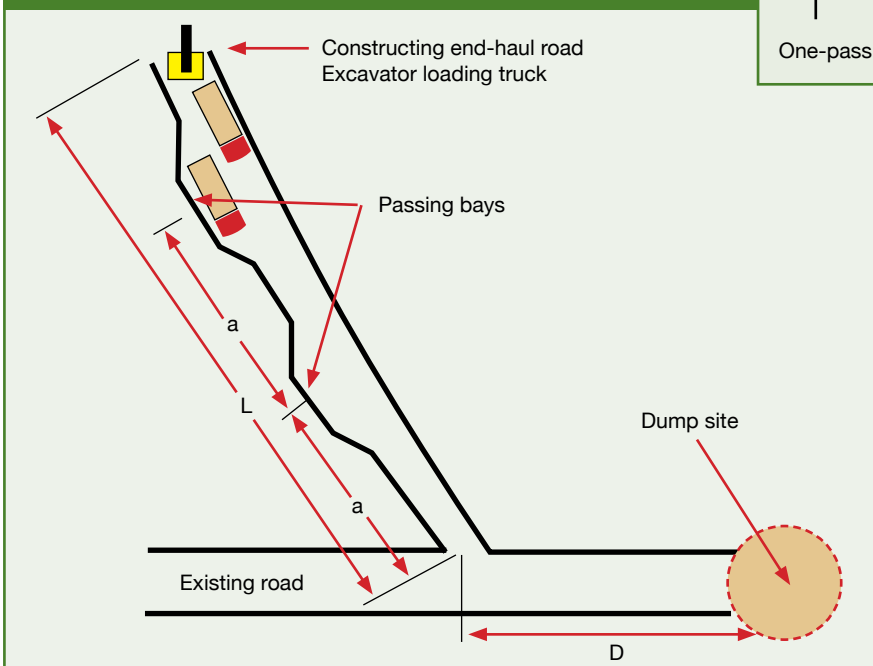

Typical end-haul road construction with passing bays

The two-pass method is ideal for wider formations or two-lane roads. A small pilot track is initially constructed at approximately the 3/4 mark. The excavator then constructs the final road, loading both the side cast and excavated material into trucks, while backing along the pilot track. This method is cheaper than the one-pass method because the swing time between excavation and loading is reduced. This method is only suitable if the excavated material will remain stable on the side of the hill while awaiting disposal.

The steps involved when end-haul constructing are:



End-haul construction methods. Left: One-pass method. Right: Two-pass method

One-pass method

- Remove any trees, stumps or other vegetation, and either take them from the site, or place them over the hillside
- Face the cut slope (in the direction of the road) with the excavator, and remove the material from the slope, swinging 180 degrees to load it into trucks
- Form the batter slope at the correct angle
- Shape the road camber and ditch to allow effective drainage.

Two-pass method

- Place the pilot track at the 3/4 mark by stripping any trees or stumps, vegetation, top soil and side cast
- Facing back down the road, the excavator digs beneath itself backing along the pilot track. In this case, the excavator only swings 90 degrees to load the trucks
- Form the batter slope at the correct angle
- Shape the road camber and water table to allow effective drainage.

Reducing end-haul costs

End-hauling is expensive, and costs can rapidly escalate if not carefully planned and managed. Minimising the amount of earthworks, using the right equipment, providing passing bays, and reducing the distance to the dump site are ways of significantly reducing cost. The simplest method is to reduce the amount of

material excavated. Excavator production can be considerably slowed by hard rock. Disposal site distance has the largest impact on costs, as cost increases directly with an increase in disposal site distance. The required number of trucks to keep up with the excavator will also increase, since it takes longer for trucks to return to the loading position.

Ideally dump sites should be flat – for example, abandoned landings or roads. More than one dump site may be required, and it is important to plan their location to avoid delays during construction. Installing passing bays at regular intervals along a one-lane road construction will increase production, since the excavator has less time to wait for the next truck to load. Usually bays can be constructed within naturally occurring areas where the terrain is flatter. Where no flat areas exist, a passing bay should still be constructed so that maximum turnout spacing does not exceed 300 m. Consideration could also be given to using specialised 6-wheel drive articulated dump trucks designed specifically for moving large quantities of earth in rough terrain. They typically have a capacity of 15 m³, and their all-wheel drive and large tyres allow them to travel quickly. They can also drive on soft and wet ground without the need for aggregate, which can be applied once the road formation has been completed. The effect on end-haul cost using other types of machinery can also be evaluated.

5. Road and landing construction – continued

5.7 Drainage control during earthwork construction

It is critical not to neglect drainage during earthworks construction. Earthworks should be carried out in fully drained conditions with no free water on the working surfaces. Precautions should also be taken to control stormwater runoff from the construction site to ensure sediment is not discharged into a sensitive area.

Temporary drainage controls should be constructed to direct stormwater away from areas of operation and/or to drain water whenever it is seen to pond. All fill surfaces should be graded and rolled at the end of each day's work to prevent ponding and erosion. Temporary drainage will frequently include cut-off ditches to deflect stormwater runoff, temporary diversion of natural surface drainage away from the work site including bunds and sloping the cut and fill surfaces to prevent ponding and infiltration. Any materials that have become too wet or soft should be removed and dried or replaced.



Poor water control during construction can damage a road and cause severe erosion

5.8 Earthwork machinery

Bulldozers and excavators are widely used in road construction in New Zealand. Up until about the mid-1980s, bulldozers were the machines of choice. There are many advantages of pairing up dozers with

excavators as each machinery type has significant advantages over the other and jointly, they lead to a better-quality job. However, excavators are much more adaptable and useful.

The earthworks machinery needs to be matched with the intended job. Bigger is not always better. Sometimes it is best to forego operational efficiency and substitute a different, less efficient machine to achieve an improved outcome. For example, use an excavator to shift and carefully place material rather than use a dozer which has less control over the material.

There are strict requirements to machinery protective structures within forestry. Refer to WorkSafe's *Approved Code of Practice for Operator Protective Structures on Self-Propelled Mobile Mechanical Plant*.

The operator is as critical to the job as the right machinery.

5.8.1 Excavators

Correct excavator specifications are important to obtain the best performance. Local conditions will determine the selection of the most appropriate boom and bucket configuration for the soil types and construction method. This will affect the production rate.

There are several classes of buckets. They range from extra heavy duty for rough rock and other severe applications, to heavy duty for use where rock is encountered occasionally, and medium and light duty buckets for soft materials. Buckets can be changed in a matter of minutes using a quick coupling system.

As a rule, the softer the material the wider the bucket that can be used, and vice versa. For excavating hard materials, a boom and a short tip radius bucket achieve the highest tooth forces. Using a short boom will reduce the reach but increase the digging force. A short tip radius bucket will increase the breakout force. In hard rock reduce the bucket width to apply a higher force. A wider bucket can shorten the boom life through the twisting action, which occurs when the bucket corner hits a 'fixed' object while digging.

It is widely thought that excavators compact the



soil through track rolling. However, excavators typically are not very effective because their tracks are designed to minimise ground pressure. Also track rolling is not efficient due to an excavator's slow travel speed and low ground pressure.

Excavators that work in the cutover as part of their normal operation need additional protection for forestry work. A protective plate under the upper structure is needed to protect against debris being pushed up from underneath.

5.8.2 Bulldozers

Bulldozers are commonly used to clear the right-of-way, to cut and fill, and to construct an even subgrade. Match the machine size with its intended use. The weight and horsepower of the machine determines its ability to push. Local conditions will determine the selection of the most appropriate size and configuration for the topography, geology and soil types. This will affect the production rate.



There are a range of bulldozer blades available, dependent on the individual machine. The blades and their intended use are:

'U' – Universal, large wings for moving large loads over long distances

'S' – Straight, most versatile 'all-rounder'

'A' – Angling, can be positioned straight or angled 25° to either side for side casting

'C' – Cushion, designed for large tractors for push-loading scrapers, but may be used for general dozing jobs.

5.8.3 Advantages of excavators compared with bulldozers

As mentioned above, dozers and excavators have areas of road construction in which they excel. The following compares the advantages of these machines:

Excavators

- Are more precise at formation in difficult topography than a bulldozer
- Handle materials that may be inaccessible to a bulldozer
- Have better control over material, leading to a more consistent subgrade. Can select and borrow suitable rock and blend other formation materials
- Have lower track ground pressure, enabling them to work in wetter terrain



5. Road and landing construction – continued

- Can work in a narrower construction corridor, leading to less soil disturbance. For example, a steep side hill cut is easier with an excavator because less material needs to be moved
- Are superior for back sloping and for working around rocks
- Can easily and effectively put in water control structures. They are ideal for culvert installation
- Great at upgrading existing roads, to load gravel, to extract hard fill, and to work in environmentally sensitive areas such as river crossings
- Are more general purpose than bulldozers.

Bulldozers

- Much more effective at moving material short distances
- More efficient stumping with some exceptions, for example wet areas
- More efficient at levelling the road.

5.8.4 Scrapers

Scrapers are employed where large volumes of subgrade materials have to be transported over longer distances than bulldozers can economically push. Scrapers require specially skilled operators to work efficiently and effectively.

5.9 Estimating machinery production

Estimating the cost of the job is crucial. Budgeting and tracking actual versus estimated costs are a core component of managing costs. No matter how the job is ultimately paid for, whether on hourly machine rates or rate per unit of production, awareness of productivity is essential.

Most companies have detailed historic records of productivity. Actual costs can vary significantly between roads, even in similar terrain. Rock may be encountered that had not been anticipated or the weather may have not been favourable. Using accumulated cost data, if it has been reliably collected, is the best way to estimate production. Ideally, it is detailed to a machine level so that each component of the construction phase can be analysed.

Another option is to use the production equations

and graphs (page 81). These give broad level estimates. They should be used with caution. They become out of date because machinery productivity changes with new models and technologies. If you base your production rate on production type studies, beware of the challenges with this work. Do the operators work as hard or as efficiently with someone measuring their every movement? Maybe yes, or maybe no.

Also, it could be useful to seek expert advice. There are consultant companies that track machine rates and productivity across the sector; they can provide baseline data for your area. This comes with its own challenges, because it is essential that the comparison is not one of ‘apples with oranges’.

5.9.1 Bulldozer production

Estimate bulldozer production using the production curves shown in the graph on page 81. It should be noted that other factors need to be applied to these production estimates, depending on the work conditions. The graph (page 81) shows that larger dozers are significantly more productive. However, the key requirement is that the dozer needs to be fit for purpose, so larger is not always better.

For forest road construction, where side casting is applied, an average dozing distance of 30 m is considered appropriate. The table on page 81 lists the estimated production in loose cubic metres per hour (Lm³/hr).

Use the graph at right (or your own figures) to calculate production rates. Use the following equation to calculate earthworks cost (C) (\$/m³):

$$C = \frac{V}{P} F \times S \times R + T$$

Where:

V = Total in-place volume of earthworks (m³)

S = Soil swell factor (table below)

P = Dozer production (Lm³/hr)

R = Hourly charge out rate, including operator (\$/hr)



Estimated dozing production

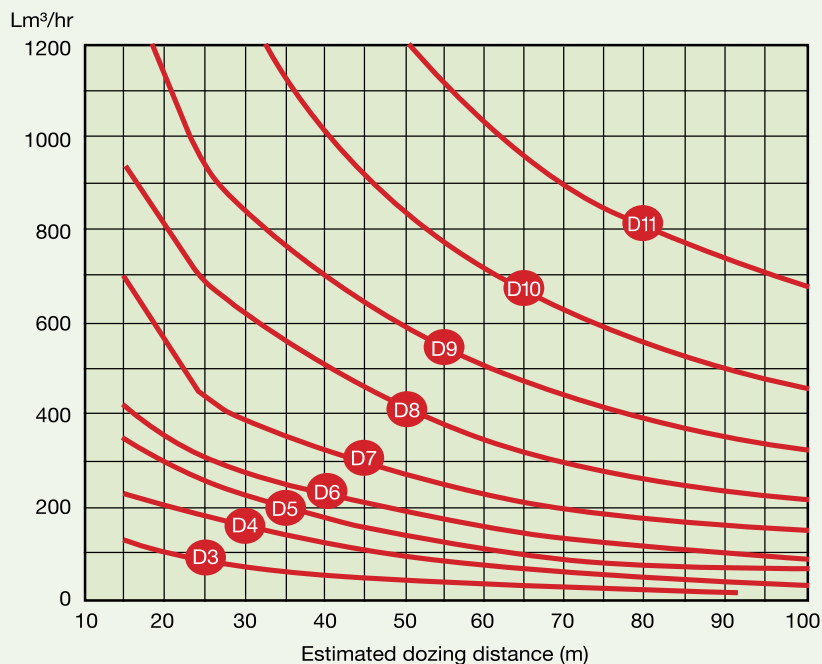

5.9.1 – Estimated production for various dozer types (Source: Caterpillar Performance Handbook)

T = Total cost to transport dozer to site (multiply km from depot to site by the appropriate cost per km, and add the unloaded and loaded costs)

F = Job condition correction factor – multiply together all the factors that apply in the table below left.

Job conditions greatly affect productivity. The worst-case scenario is a poor operator who takes lots of breaks or has machinery breakdowns, and is working in poor conditions with a bad material. These jobs need to be well managed as they can lead to major budget 'blow-outs'.

Soil swell factors	
Attribute	Correction factor
Clay – natural bed	1.22
Dry	1.23
Wet	1.25
Clay & gravel	
Dry	1.18
Wet	1.18
Decomposed rock	
75% rock, 25% earth	1.43
50% rock, 50% earth	1.33
25% rock, 75% earth	1.25
Earth – dry packed	1.25
– wet excavated	1.27
Loam	1.23
Granite – broken	1.74
Gravel – pitrun	1.12
Limestone	1.79
Sand	1.12
Sand & clay – loose	1.27
Sand & gravel	
Dry	1.12
Wet	1.10
Sandstone	1.77
Shale	1.33
Stone	1.77
Topsoil	1.43

Job condition correction factors	
Attribute	Correction factor
Operator	
Excellent	1.0
Average	0.75
Poor	0.70
Material	
Loose stockpile	1.20
Hard to cut: frozen	
With tilt cylinder	0.80
Without tilt cylinder	0.70
Cable controlled blade	0.70
Hard to drift: "dead"	
Very sticky material	0.80
Rock, ripped or blasted	0.70 – 0.80
Slot dozing	1.20
Side by side dozing	1.15 – 1.25
Visibility	
Dust, rain, snow, fog or darkness	0.80
Job efficiency	
50min/hr	0.83
40min/hr	0.77
Direct drive transmission	
0.1 min fixed time	0.80
Using A-Blade or C-Blade	0.50-0.75
Grades	See figure 68

Above: Source: Caterpillar Performance Handbook

Left: There are large variations between materials so plan accordingly (Source: Caterpillar Performance Handbook)

5. Road and landing construction – continued

5.9.2 Excavator production

Excavator production is dependent on average bucket payload, average cycle time and job efficiency. The production can be derived from the following formula:

$$P \text{ (m}^3\text{/hr)} = \text{Cycles/hr} \times \text{Avg Bucket Payload (m}^3\text{)}$$

The digging cycle of the excavator comprises four segments:

1. Load bucket
2. Swing loaded
3. Dump bucket
4. Swing empty.

Excavator production can be estimated from the graph on the right.

The work conditions are defined as follows:

Excellent

- Easy digging (unpacked earth, sand gravel, ditch cleaning etc) to less than 40% of machine's maximum depth capability with

Excavator production

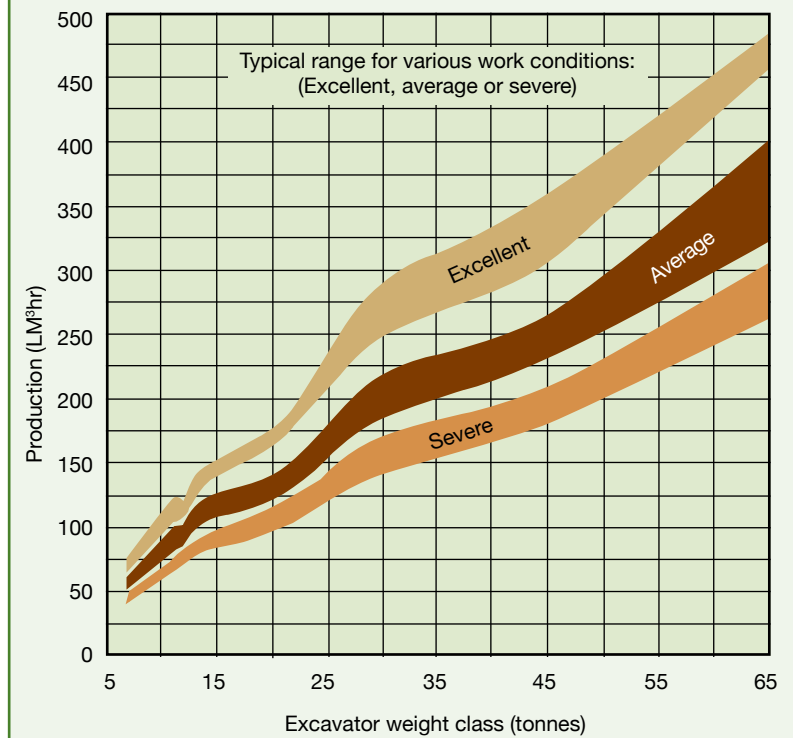

Excavator production for various work conditions. Production is in loose cubic metres and should be divided by the appropriate soil swell factor, see graph above. (Source: Caterpillar Performance Handbook)



Severe low production digging with a single ripper tine smoking away

a swing angle less than 30°. Dump onto spoil pile or truck, with no obstructions and an experienced operator

Average

- Medium digging (packed earth, tough dry clay, soil with less than 25% rock content), depth to 50% of machine's maximum capability, swing angle to 70°. Large dump target with few obstructions

Severe

- Hard digging (shot rock or tough soil with up to 75% rock content), depth to 90% of machine's maximum capability and swing angle to 120°. Shored trench. Small dump target.



5.10 Stabilising cut and fill slopes during construction

Well-constructed roads are safe, they minimise environmental impacts, and are cost effective to build. Implicitly, a major component to meet these objectives is constructing a stable road. Stabilised cuts and fills are therefore an essential part of a well-constructed road. This includes the ongoing stability of cut batter slopes, constructed fill slopes, and slopes adjacent to waterways, river margins, culverts and bridge abutments. All components of the road need to be stable – the cut banks, ditches, road carriageway, berms, and fill slope. A core component of road stability is water control. Dilute and disperse, especially away from fills, is a fundamental requirement of any road. Water control is discussed in detail throughout this Manual.

Poor practice can lead to significant sedimentation and high maintenance costs until cuts and fills self-stabilise. Fixing poor construction is often more expensive than doing

it right, first time. Organic material, stumps and other vegetation should not be used as fill material, because it will not compact to a hard surface, and may eventually break down, leaving soft spots which could develop into holes and embankment failures.

Vegetative and non-vegetative methods to reducing erosion on cut and fill slopes will be discussed in Chapter 7, Erosion, Sediment and Slash Structures.

Engineered stabilisation structures will be briefly covered but these generally require technical engineering input so are beyond the scope of this Manual.

5.10.1 Methods available to stabilise earthworks

Ways to stabilise earthworks include:

- Compaction of fill
- Benching
- Correct cut and fill angles including benched cut slopes
- Appropriate water control
- Controlling erosion and sediment including vegetative and non-vegetative methods
- Engineered stabilisation structures like gabion baskets, geosynthetic matting and textiles (discussed later in this section).

Selecting an appropriate cut and fill angle is critical to the stability of the earthworks. Soil has a natural angle of repose, and slopes that are steeper than this will have increased shear stress and potentially fail when they become saturated. The type of material will dictate the cut and fill slope batters. Cut slopes are challenging because opening up the in-situ material often leads to a certain amount of slumping, irrespective of how well they are planned and the mitigation measures that were in place. For example, slumping can occur, especially after prolonged rainfall, even if cut batters are at the correct angle for the material, and the bank has been oversown. The tables on page 84 give ranges of values for these by material type.

The easiest way to determine what works in your area is to drive around existing roads,



It is essential to remove all stumps prior to formation

5. Road and landing construction – continued

Cut batter slopes	
Material types	Maximum cut slope
Sand	1.5h-2.0 h to 1.0 v (67% to 50%)
Pumice	1.0 h-0.25 h to 1.0 v (100% to 400%) Depending on cementation
Ash	0.5h-0.25 h to 1.0 v (200% to 400%) Some slumping accepted
Clay, loose gravel, topsoil	0.75 h to 1.0 v (133%)
Compacted gravelly, clay boulder and earth mix	0.75 h to 1.0 v (133%)
Tight cemented gravels, papa, mudstone	0.5 h to 1.0 v (200%)
Average rock	0.25 h to 1.0 v (400%)
Solid rock	Vertical

Fill batter slopes	
Material type	Maximum cut slope
Sand	2.0 h to 1.0 v (50%)
Pumice	1.5 h to 1.0 v (67%)
Clay	1.5 h to 1.0 v (67%)
Rock, dumped	1.25 h to 1.0 v (80%)

with similar material type, and see what angle provides the most stability.

Lowering the batter angles leads to more earthworks and additional construction costs. However, maintenance and the potential for environmental effects are reduced. In some situations, it initially appears counter intuitive to have steep batter for some materials like pumice. Steep batters reduce the amount of rain intercept and rilling or erosion.

Once a stable angle of repose is reached, there is little benefit in further flattening, since this will only increase the area of exposed soil, and, therefore, the susceptibility to erosion. Changes in slope angles should be rounded to reduce erosion potential. Rounding the top of cut batter slopes reduces the tendency for material to erode from the edge of the batter.

Ensure the clearing limits or the road are sufficient so that stumps close to the edge of the cut banks will not be undermined, leading to maintenance issues.



Papa/mudstone can have steep batter slopes which also reduce the volume of material that needs to be moved

5.10.2 Benched cut and fill slopes

The stability of large cut slopes can be improved by removing some of the overburden material to reduce the shear stress. An example is the benching above the road level, see diagram on page 85. By doing this, the slope must only support approximately 2/3 of the original overburden material. The bench should be in-sloped and have a ditch installed at the toe. Failure to install appropriate drainage may cause the cut slope to become saturated – dramatically increasing the likelihood of slope failure.

Fill slope stability is greatly improved by constructing a bench below the road to contain the compacted fill. This is discussed in an earlier section on balanced cut and fill construction methods.

Where possible, revegetate as quickly as possible. An interim measure for fill slopes is to oversow, hydroseed, or have material like slash or hay placed over the fill to help intercept the rain and slow down its velocity. Maintain cut and fill batters, and water control structures like ditches, berms, culvert inlets, and flume outlets especially where they are prone to erosion. For example, if they are constructed from light, mobile material like ash and pumice, and are in areas that have high intensity rainfall.



Benched cut slopes

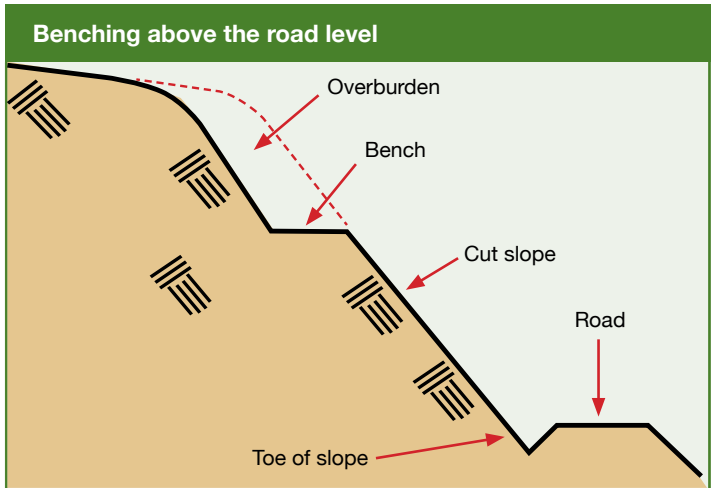

5.10.3 Retaining wall structures

When there is inherent cut bank or fill slope instability that standard forestry roading stabilisation techniques are unlikely to effectively control, additional specialist engineering methods may be required. Do not try constructing these if you are not a certified engineer. This section will give an overview of retaining wall techniques used overseas that are not used or have had limited use in forestry in New Zealand. Some of the structures are widely used in council and national roads here. For example, mechanically stabilised earth structures (MSES), timber counter-levered pile walls and gabion structures. It is likely they are not used in forestry because they require expert technical input, are expensive, and forest engineering contractors may not be skilled in their construction. Retaining walls can be used for both new construction and slope failures.

Retaining walls can be used in forest road design and construction to increase slope stability and reduce soil erosion. Wall design should consider the different site factors like geology, soil type, and groundwater and of the required wall attributes like type, length, and height. Their initial cost is offset through road whole life costs reduction, mainly due to reduced maintenance.

A significant advantage for new road

construction is that retaining walls reduce the gradient and length of cut and fill slopes by:

- Reducing the total road width and excavated material
- Increasing productive area, as less area is within the roadway
- Increasing stability through the structure.

Constructing a successful retaining wall requires

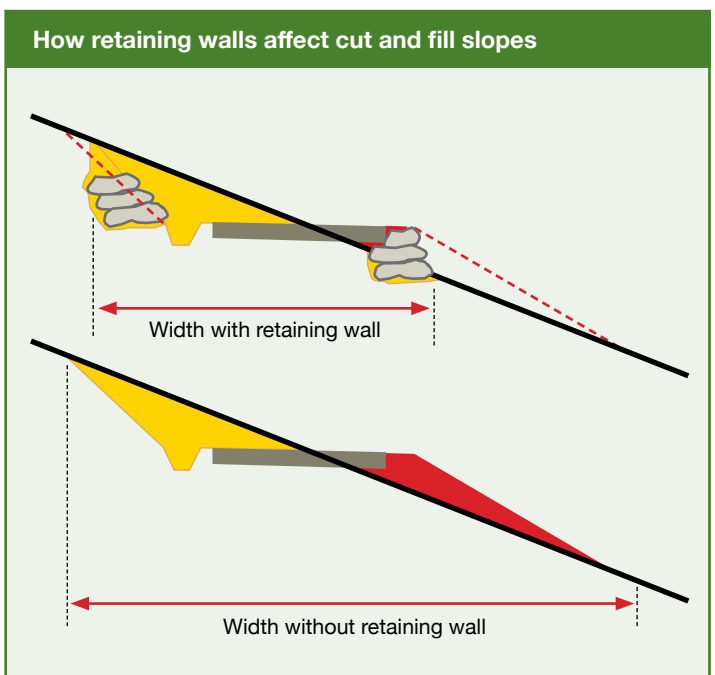

The use of retaining walls reduces the gradient and the length of the cut and fill slope

5. Road and landing construction – continued

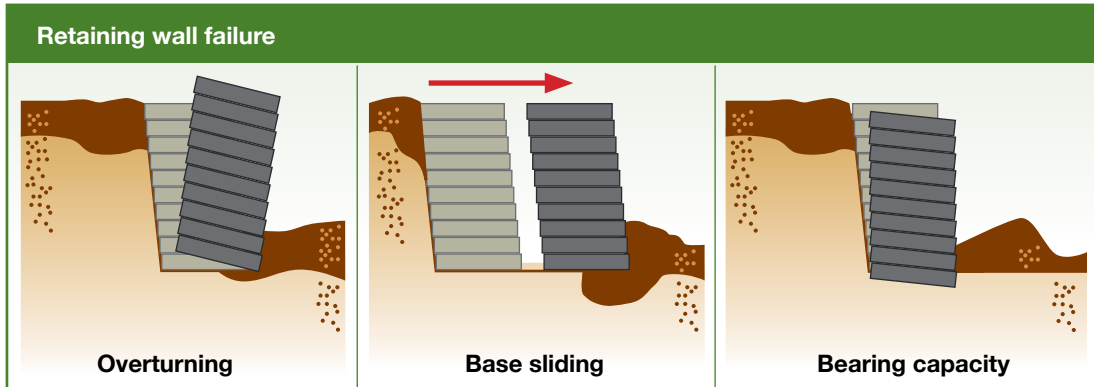

Three ways retaining walls can fail

design and construction focused on wall stability. Many of the commercially available retaining wall options will come with design guides, but obviously for more substantive or complex structures geotechnical expertise is strongly advised. There are three separate stability aspects to consider – external, global and internal.

The external stability is based on three criteria:

- Overturning resistance – either through soil movement or water pressure. The most common failure of retaining walls is ‘overturning’, where the structure is pushed forward over time. Ensuring good drainage immediately behind the structure is the main design criteria to limit the soil pressure on the wall. A heavier or stronger wall with greater back leans will help resist the overturning moment, but you might need to anchor the retaining wall back into the soil. Overturning failures typically develop over time and initial movement will be readily visible.
- Sliding resistance – as above, soil movement will push the retaining wall forward. If the wall is not anchored adequately with the ground, the whole structure might push forward. Ensuring a strong wall to ground interface prevents the wall from sliding forward.
- Sufficient bearing capacity of the underlying soil – most retaining walls will have considerable weight and as such, the ground underneath should be strong. For any ground that is not rock, this normally means some compaction is required, whereby using geogrid materials can also work well.

Where external stability analysis takes into consideration the wall and the terrain condition where it will be constructed, global stability considers the surrounding environment in terms of mass slope failure. This looks at the effect the retaining wall structure might have on the stability of the wider area. Unlike the external stability issues, global failure is likely to be more dramatic and less predictable. During maintenance the surrounding ground should be inspected for signs, such as cracks in the ground, that may indicate global movement.

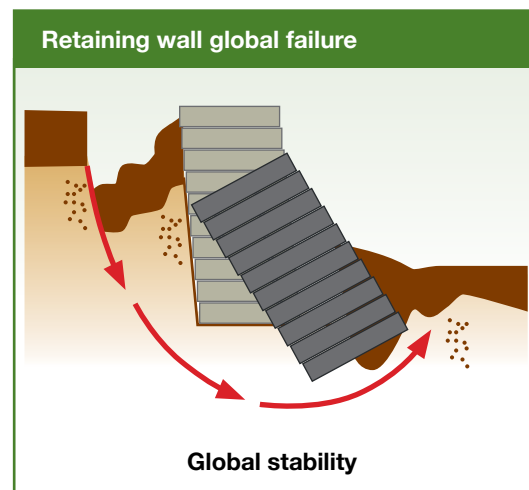

Most retaining walls are designed using multiple elements. The design and construction should consider the internal stability in terms of bulging, internal sliding and topping. Most commercially available systems will come with recommendations on how the elements should be combined.

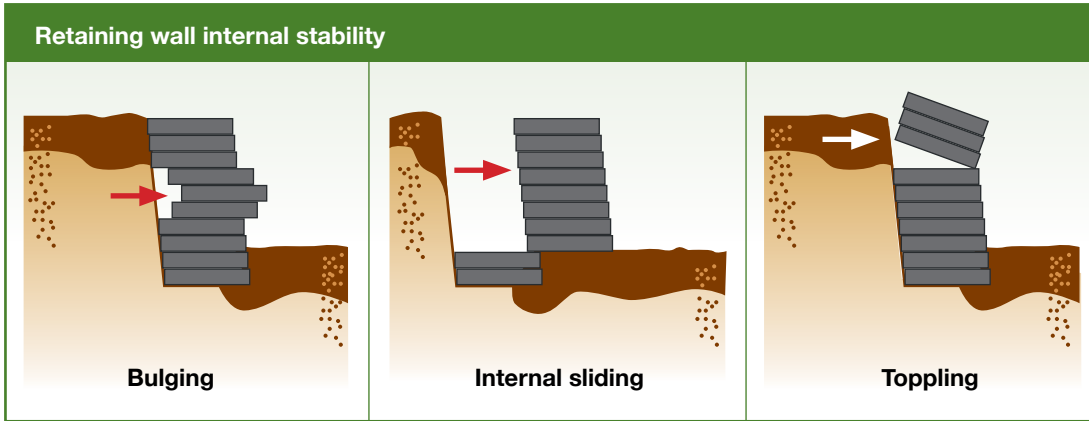

Mechanically stabilised earth structures

Mechanically stabilised earth structures (MSES) are made by overlapping layers of soil reinforced with wire mesh and or geosynthetic materials (geotextile and geogrids) until reaching the needed wall height. Each layer is built using an appropriately shaped container, and is infilled with compacted soil.

The main advantages are the simple materials used, low cost and fast construction, minimal foundation preparation (typically), and that they can sustain large loads. The structure can be hydroseeded to look like a typical fill over time. The main disadvantages are the high amount of excavation required, the needs of well-skilled operators and the good quality of filling soil (compaction susceptibility).



MSES fill slope of a forest road

5. Road and landing construction – continued



Gabion wall being constructed to support a fill slope

Gabion structures

Historically, boulders have been the most commonly used material to construct gravity walls. However, the introduction of the gabion basket system now makes them the preferred and proven gravity options through their flexibility and reliability.

Gabion structures are designed to support slopes, and to provide erosion protection. They are ideal for use as a gravity retaining wall to support steep cut and fill slopes where the optimum cut or fill slope angle would produce a large exposed surface, or where the fill slope would otherwise encroach into a waterway. The retaining wall can be stepped, sloped, or vertical, depending on the situation.

Wire mesh baskets are filled with stones, rock or rubble, and are laced together to form a continuous structure. There are two main types of gabion structures – gabion baskets and gabion (reno) mattresses. The former is designed to use their mass to support a toe of a slope, or to provide an effective retaining wall.

Gabion basket

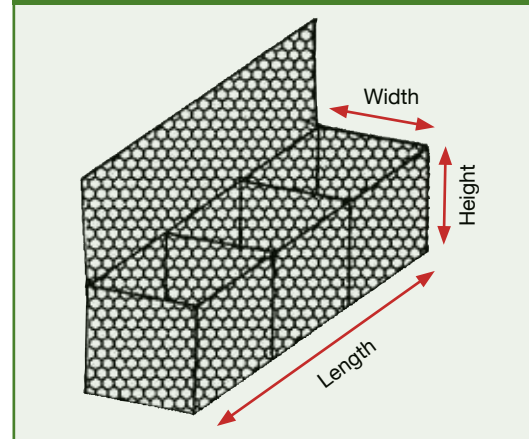

The latter may be used to overlay a riverbed or other surface, to reduce the erosion effect of water flow. The high permeability of gabions provides free drainage through the structure, which reduces hydrostatic pressure. This is an advantage in areas where high seepage flows are expected. Gabion baskets and mattresses should be provided with a geosynthetic filter



fabric placed between the backfill and the basket to prevent the loss of fines from the fill through the basket.

Both gabion baskets and mattresses are flexible because of the combination of mesh and rock fill. This flexibility allows them to be used in variable conditions, such as soft or unstable ground where movement is expected due to settlement or frost heave etc. They are ideal for river and waterway erosion control, bridge abutments and approaches, slope stabilisation and toe support. Different sizes of wire mesh baskets are available commercially – they typically range from 2 m in length, 1 m in width, 0.5 m in height to 4 m in length, 1 m in width, 1 m in height. The wall is constructed by step-stacked layers with the resulting structure able to sustain heavy loads. Gabions tend to be a very cost-effective solution. They use material that is usually obtainable on site – any solid, hard material such as rubble, broken rock or concrete. The main disadvantage of this solution is the visual impact.

Gabion baskets and mattresses can be used on their own, or in combination, to form effective bridge abutments. Gabions can also be used to provide erosion protection of existing abutments.

Reno (gabion) mattresses are used to reduce water velocity and eliminate scour of the waterway bed, especially downstream of a

ford or battery culvert. Mattresses are laced together to form a continuous mat overlaying the waterway bed. Mattresses are generally manufactured 6 m in length, 2 m in width and in thicknesses of 240 mm and 300 mm. They are flexible and, therefore, can be folded to accommodate undulating ground conditions. If additional erosion control is required, the mattresses can be overlaid with concrete.

Timber cribs

Timber cribs are a traditional retaining wall option in some parts of the world. The construction components are logs with high



Treated timber crib as retaining wall of forest road fill slope. Never use untreated radiata logs as they are not durable

Timber crib construction overview

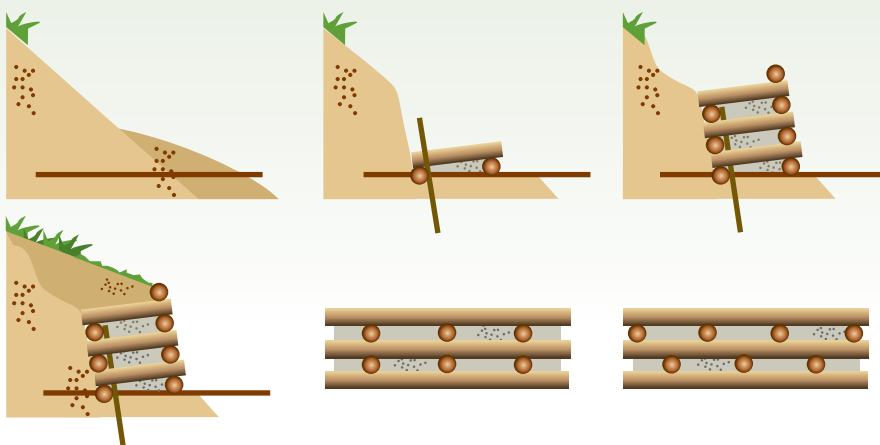

Crib construction spike component

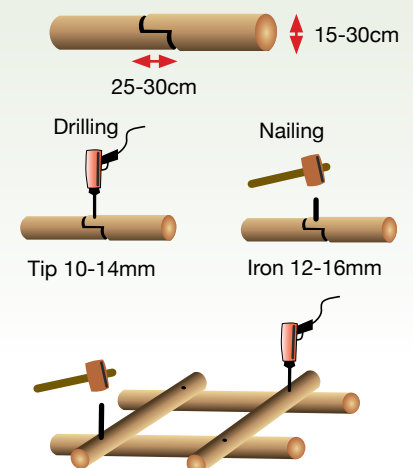

5. Road and landing construction – continued

natural durability, stones and spikes. The space between the layers are filled with stones and, where necessary, geotextiles and drainage pipes may also be used. The logs are connected with spikes 20-30 cm in length and 10-12 mm in diameter. The result is a highly water-permeable and cost-effective structure. When compared with a gabion, it is aesthetically more pleasing, the construction materials are less expensive, but the construction is more laborious.

Timber cantilever pile wall

Another common retaining wall design option is using vertical poles fixed in the ground that sustain horizontal logs or lumber containing the backfill soil. These are common outside forestry in New Zealand. The design should consider the bending resistance of the poles used and pole depth into the soil. A rule of thumb is that the depth of the poles should be as the wall is high. Cantilever pile walls are a low impacting solution with the major advantage is a low amount of excavation. However, on ground with bedrock or soils with larger rock components it may be difficult to drive piles to the necessary depth and other options need to be considered. Use either ground durable or treated wood for structures. A good reference is www.croftpoles.co.nz/wp-content/uploads/2012/02/Croft-Poles-retaining-wall-guide.pdf



Timber cantilever retaining wall



Chapter 6

Pavement design, subgrade preparation, pavement construction



6. Pavement design, subgrade preparation, pavement construction

Unsealed gravel (or aggregate) road pavements are the most common type of forest road construction. They are technically referred to as unsealed flexible pavements.

The pavement layers elastically deform beneath the vehicle load to disperse the stress to a level that the subgrade soil can bear. Like planning, correct pavement design is critical for a fit-for-purpose road that allows truck traffic to move effectively in all but the worst weather conditions, be safe and have minimal long-term environmental impacts.

The pavement can account for a large percentage of the total road cost, and subsequently, there can be substantial savings in construction and maintenance costs by getting the pavement design and construction right. This becomes increasingly critical as the distance from the aggregate source increases, because transporting aggregate gets increasingly expensive as the cart distance lengthens.

Sealed or paved surfaces are seldom used in most forest applications and are not discussed in this Manual.

Subgrade strength is an important factor influencing pavement design; a formal assessment at the planning stage can lead to more cost-effective road construction. Once the subgrade strength has been identified, the pavement thickness for a given traffic loading can be calculated, based on the axle loads being applied. A thicker pavement layer distributes stress over a larger area, enabling the subgrade to withstand larger loads or a higher number of repetitive loads. This load distribution by the pavement layer is very important, because most subgrade materials will not have sufficient strength to carry a large number of heavy axle loads applied directly. A weak subgrade will require a thicker pavement to distribute the applied traffic loads, or conversely, the subgrade can be strengthened to reduce the thickness of pavement.

The objective of pavement design and



A grader is used to spread the pavement layer over the newly formed road. This layer, when compacted correctly, will provide a good, strong running surface and prevent moisture from infiltrating through to the base course or subgrade layers



Flexible pavements

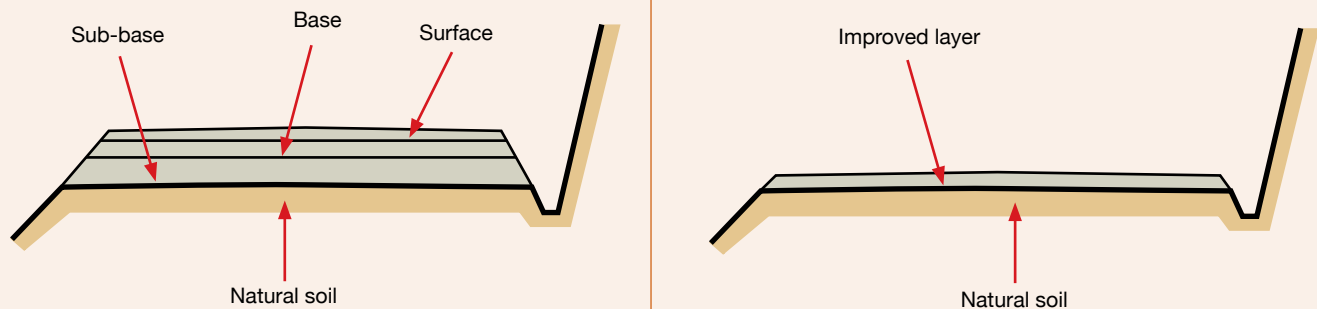

Flexible pavements are constructed as multiple-layer pavements (left) or as single layer pavements (right). (Source: *Forest Road Operations in the Tropics, J. Sessions, 2007*)

construction is to produce fit-for-purpose pavement which will perform the following functions with an acceptable level of maintenance:

- Distribute the pressure from the wheels, so that the load can be supported by the road foundations (subgrade)
- Protect or shield the subgrade from water, so the strength of the underlying soils is maintained or improved
- Provide a surface that has sufficient traction, so that vehicles can climb and brake safely.

The layer of material closest to the surface needs to be sufficiently strong to withstand the direct vehicle load, while successive layers beneath the surface can be of lower strength as the vehicle load disperses. Public road pavements are generally constructed using a traditional multiple layer design, whereas most forest roads will use a single improved layer design. Both methods work adequately in terms of being fit for purpose if constructed correctly; however, the multiple layer approach tends to be more expensive to construct, both in terms of material and cost.

The function of the surface course, also called the 'running course', is to provide low permeability with a smooth finish that is resistant to ravelling and scouring. These attributes help seal the road surface and provide a good running surface for traffic. Running course is not often applied on forestry roads, or if it is, it tends to be on steep adverse grade sections where a good surface is required. A

well-graded fine aggregate, such as AP20, is typically used. Note that AP20 refers to a designed aggregate standard (AP) where the larger particles are 20 mm in length. The AP standards have a defined particle size distribution, to ensure the particles lock together when they are compacted.

The function of the base course is to withstand the high stress concentrations immediately below the traffic load, and to distribute the stress to the lower levels of the pavement and onto the subgrade. The material should be compacted to achieve a high binding effect. The base course should have good crushing strength, and a good proportion of broken faces to distribute load and take shock load. A well-graded AP65 is suited for use as a forest road base course.

The purpose of the sub-base is to distribute the load onto the subgrade. It is usually a lower quality, and therefore a lower cost, aggregate. For example, weathered rock or river run, since its position low down in the pavement means that it is subject to less stress. The sub-base material should have good compaction and a high proportion of large aggregate material to help spread the load across the subgrade.

Pavement design can be challenging. Design requirements will change among roads within and between forests as subgrade properties and vehicle loading change. Company standards on pavement design need to reflect this variability. Ideally, the pavement for each section of new road should be individually designed. The use of a standard design for all roads within a forest or estate runs the risk of either over or

6. Pavement design, subgrade preparation, pavement construction – continued

under engineering pavements. This will result in roads that are either excessively expensive to construct or fail and require extensive maintenance to repair.

The key factors in pavement design are:

- Traffic loading (maximum axle loads, tyre pressure and number of loads)
- Subgrade soil strength
- Pavement layer material properties
- Pavement thickness.

Using the fit-for-purpose design approach, it is highly likely that some segments might not meet expectations right after construction, from factors such as lower than expected subgrade strength or the improvement layer failing to compact adequately. A pragmatic method at time of construction is to see if the road deforms under a loaded metal truck and to add aggregate (or compaction effort) in those locations.

6.1 Traffic loading

Axles passing over a pavement generate stresses within the pavement that are transferred to the subgrade. These stresses cause two types of strain – resilient and permanent strain. Resilient strain deforms the pavement when the axle load is applied, but rebounds when the load is removed. However, with permanent strain, the deformation remains after the axle load has passed. While this might initially support compaction, over time the

road starts to deform – that is, rut – and typically, the incremental damage will quickly accelerate with each passing truck.

The level of expected traffic and the various truck types must be estimated when designing a pavement. Forest roading is unusual in that roads are either sparsely used by light vehicles or, during harvest, have a high proportion of high axle loadings. Another aspect unique to forestry roading is the use of off-highway, oversize, heavy vehicles which can have axle loadings that exceed the legal highway axle loading.

The design traffic for a pavement is expressed in terms of the number of equivalent standard axles (ESA) which are expected to travel the pavement during the design period. The ESA number is a measure of the equivalent damaging effect to which the pavement will be subjected as a result of the passage of the total estimated traffic.

The design period is the time a pavement is required to be in service without requiring major rehabilitation or reconstruction. The design period is influenced by a number of factors, including the cost of capital expenditure, road class, intended usage, seasonality of use and location. For example, there is no need to design a secondary road to withstand the expected traffic loadings for 10-20 years, if it is only likely to be used for a few years of harvest, and then lie with minimal traffic until harvest of the next forest crop.

The standard axle used for the ESA design method is a single axle dual tyre configuration loaded to 80kN (8.15t). Each dual wheel load is taken as being applied to the pavement on two

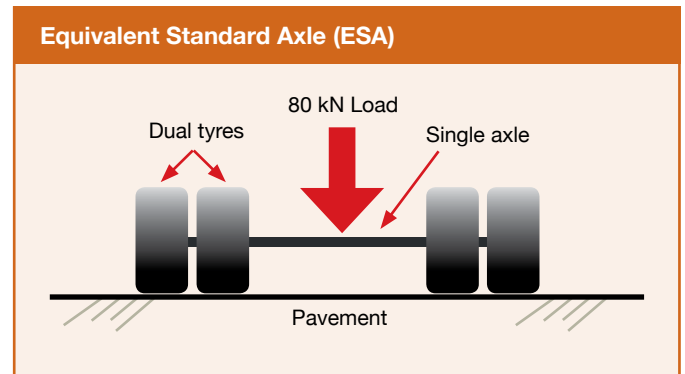
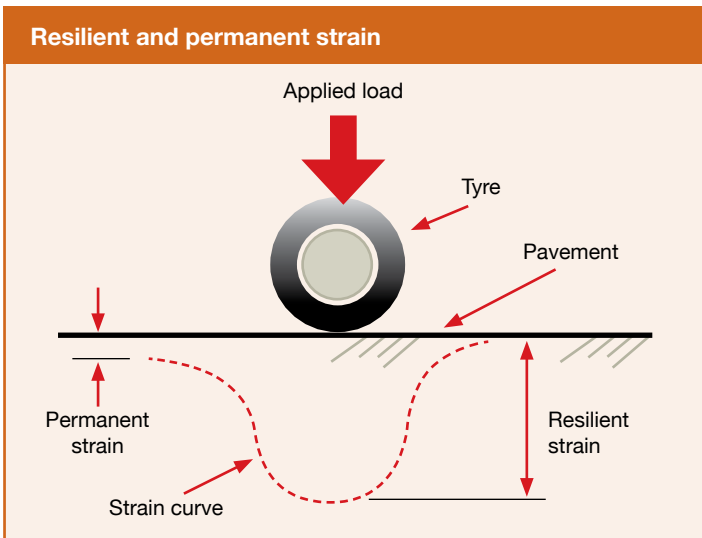

Standard 80 kN axle used for the equivalent standard axle (ESA) load method



circular areas with centres 330 mm apart, and with a uniform contact pressure of 550 kPa.

A wide variety of axle spacing and configurations of tyres and axle sets are used for heavy vehicles working within a forest. To undertake pavement design, these configurations need to be simplified into a small group of standard axle sets and loadings. For design purposes, axle group loadings are generally simplified in terms of the following five types:

- Single axle with single tyres (SAST)
- Single axle with dual tyres (SADT)
- Tandem axles with single tyres (TAST)
- Tandem axles with dual tyres (TADT)
- Tri-axles all with dual tyres (TRDT)
- Quad axle with dual tyres (QADT).

Tandem axles, with wide axle spacing in excess of 2.4 m, can be considered to be single axles, with the total load on the spread tandem configuration being divided equally between the two single axles. Twin steer axles can be considered to be equivalent to tandem axles, both with dual wheels, which are loaded to 1.5 times the load on the twin steer axles.

The table below shows the loads on each of these axle configurations that are considered to cause the same amount of pavement damage as the standard axle. For example, an 80kN load on a SADT configuration will cause the same damage to the pavement as a 181kN load on a TRDT configuration.

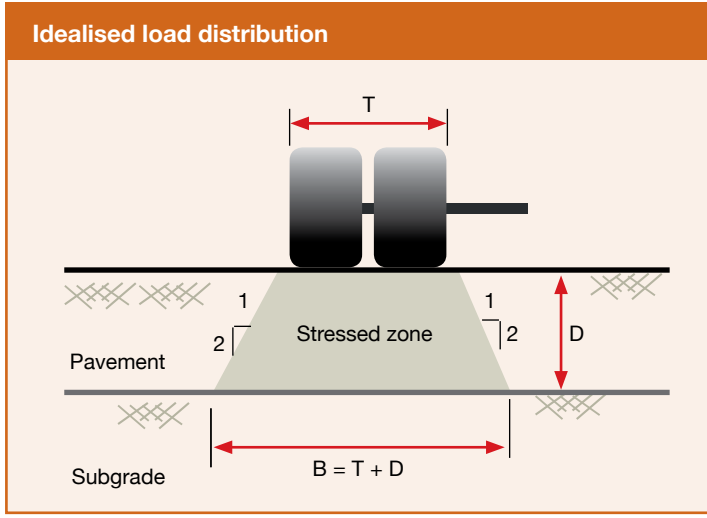
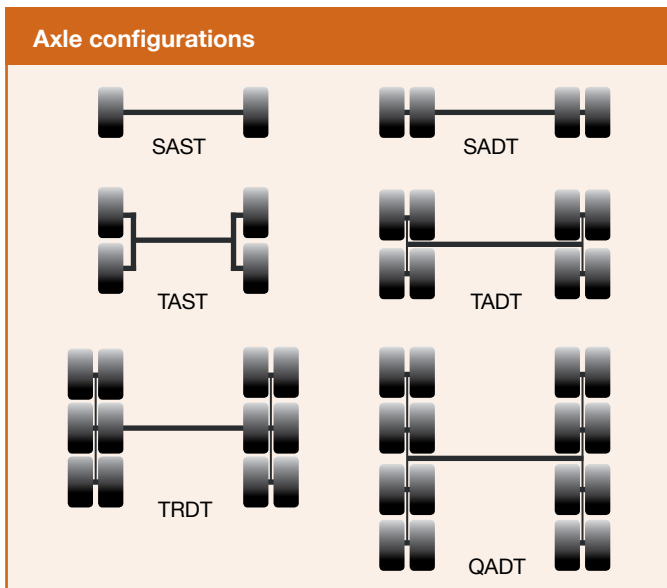

The idealised load distribution is where the stress area (circle of diameter B) of the subgrade is equal to the width of the tyre(s) (T) plus the pavement depth (D)

Axle loads causing equivalent damage		
Axle type	Standard load	
	kN	(T)
SAST	53	(5.4)
SADT	80	(8.2)
TAST	90	(9.2)
TADT	135	(13.7)
TRDT	181	(18.5)
QADT	221	(22.5)

6.1.1 Axle load equivalencies – calculating ESA

The design traffic is given in terms of the number of equivalent standard axles (ESA), and is determined by:

- Present or expected traffic volumes
- Distribution of vehicles
- Axle types and loadings
- Traffic growth rates
- Design life of the road (before major rehabilitation is required).

6. Pavement design, subgrade preparation, pavement construction – continued

When the number of passes of the configuration is equal to the number of ESA loads for which the pavement was designed, the pavement in theory will have deteriorated to the point where it is no longer useable and will need to be rehabilitated.

Axle groups operating at loads other than the standard loads shown above, need to be expressed in terms of the number of standard axles that would cause the same damage. Conversion to standard axles is achieved using the following equation:

$$\text{Vehicle ESA} = \sum \left[\frac{\text{Actual Axle Load}}{\text{Standard Axle Load}} \right]^4$$

For example, consider a logging truck operating at 44 tonnes and with the axle configurations shown in the top graphic below. The ESA for each axle group is individually calculated and summed to determine the ESA value for the vehicle. For this example, the logging truck will cause the same damage to the pavement as 3.17 standard axles.

Note (see bottom graphic) that the conversion to standard axles uses an exponent of four. The consequence is that axle groups with actual loads greater than the standard load, will cause significantly greater pavement damage. For example, the same logging truck used in the previous example increases its GVM by 50% for off-highway operation. The resulting ESA would be 16.0 – a 500% increase in pavement damage.

Logging truck operating at 44 tonnes

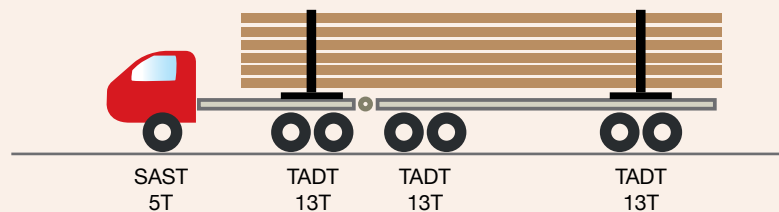

$$\text{ESA} = \left[\frac{5.0}{5.4} \right]^4 = 0.74 \quad \text{ESA} = \left[\frac{13.0}{13.7} \right]^4 = 0.81 \quad \text{ESA} = \left[\frac{13.0}{13.7} \right]^4 = 0.81 \quad \text{ESA} = \left[\frac{13.0}{13.7} \right]^4 = 0.81$$

ESA = 3.17 for this logging truck

Logging truck operating at 66 tonnes

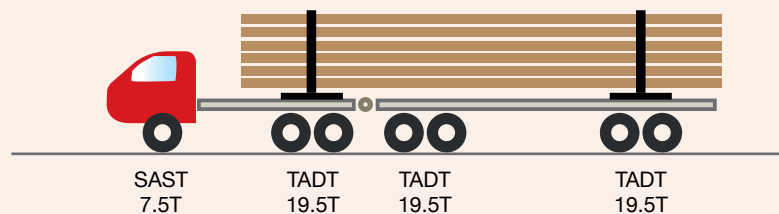

$$\text{ESA} = \left[\frac{7.5}{5.4} \right]^4 = 3.72 \quad \text{ESA} = \left[\frac{19.5}{13.7} \right]^4 = 4.10 \quad \text{ESA} = \left[\frac{19.5}{13.7} \right]^4 = 4.10 \quad \text{ESA} = \left[\frac{19.5}{13.7} \right]^4 = 4.10$$

ESA = 16.0 for this logging truck



The fourth power function means that off-highway trucks with very high payloads have correspondingly high ESA values. Pavements need to be designed for this. The higher road construction and maintenance costs need to be justified. Often the trade-off in increasing pavement construction and maintenance cost is the operational savings that occur with the use of high capacity trucks.

An estimate of the total ESA value for the design of a forest harvesting road can be calculated from the expected volume of harvest using the following steps:

- Estimate total volume of harvest (production forest area x yield per hectare)
- Estimate the number of logging truck loads (volume/average truck capacity)
- Calculate the ESA value for the typical log truck configuration that will be used for the operation (ESA per truck loaded plus ESA per truck empty)
- Multiply log truck ESA by the number of trucks required to complete the operation
- Add extra ESAs to allow for construction and service traffic (either estimate or increase wood flow ESA by 15%).

Example

A 140 ha area of forest with 550 m³/ha average yield is to be transported on a new forest road over a period of three years, following which the area will be replanted for the next rotation. The new road's pavement design ESA is:

ESA for logging truck round trip = 3.17+1.16 = 4.33

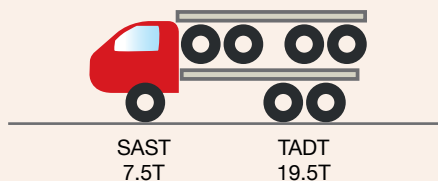

$$ESA = \left[\frac{5.0}{5.4} \right]^4 = 0.74 \quad ESA = \left[\frac{11.5}{13.7} \right]^4 = 0.42$$

- Total volume of harvest: 360 ha x 550 tonne/ha = 198,000 tonnes
- Number of loads: 198,000 tonnes/28 tonnes/load = 7,070 loads
- ESA value for logging trucks:
Loaded ESA= 3.17 (from previous example)
Unloaded ESA = 1.16
- Total log truck ESA for operation: 7071 loads x 4.33 ESA/truck = 30,620 ESA
- Allowance for construction and service traffic (15%): 30,620 x 1.15 = 35,210 ESA

The pavement for this new forest road will need to be constructed to withstand the damage that will be caused by 35,000 standard axles.

6.2 Evaluating subgrade properties

The subgrade strength needs to be assessed, together with the traffic loading (ESA), to determine the pavement thickness. Subgrade strength is influenced by the physical and mineralogical characteristics of the material, and its density and moisture content, both when compacted and in service. The best outcome is usually determined through practical experience backed up with field testing. If there are still concerns on the subgrade properties then laboratory testing may be required.



Collecting a soil sample for analysis can provide detailed information about its suitability as an adequate base layer, and can also be used to determine optimal compaction levels

6. Pavement design, subgrade preparation, pavement construction – continued

Subgrade strength can vary greatly along any stretch of newly formed road. Often, the key thing is to identify where the subgrade strength is very low. This might be evident from the wheel rut depth from construction vehicles or become visible during compaction of the subgrade. Areas of high moisture content or high clay content are of particular concern. Getting the subgrade reasonably consistent will lead to a more evenly strengthened road. Weak areas need to be fixed because they will cause subgrade failure once the road is in use. If the subgrade fails, then typically the section of road must be dug up and laid down again.

6.2.1 Using the California bearing ratio (CBR)

The most commonly used measure of subgrade strength is the California bearing ratio (CBR). It was developed back in the 1930s by the Californian Department of Transportation, to measure the load-bearing capacity of soils used for building roads. The basic test is performed by measuring the pressure required to penetrate soil or aggregate with a plunger of standard area. The rate of this penetration is then compared to a standardised Californian crushed limestone aggregate, and the result expressed as a percentage.

In terms of CBR values, the Californian crushed limestone is very strong (by definition 100%), and most highway pavement charts only require material with strength of CBR = 80%. Extensive testing of pavement material used in New Zealand forest roads show a great range from 20% through to 80%. Most subgrades at the time of construction will typically have values from 3 to 15%. A subgrade with 8% is considered just strong enough to build on. However, a CBR of less than 4% has marginal capacity to carry traffic loads. Some form of stabilisation treatment or other techniques will be required, or an alternative road alignment may be necessary to avoid the weak soils. Stabilisation techniques are discussed later in this chapter. For example, daylighting will reduce the moisture content of the subgrade and result in a significant increase of CBR.

The pragmatic problem with the laboratory-based CBR test is that it is both very time

consuming and costly to complete a single measurement, and the test itself relies on simplifications and assumptions. For example, all particles > 40 mm are sieved out or removed as they can affect the result, but most pavement aggregates have a relatively high percentage of this larger material. Also, because the tests are for highway design, it very much focuses on strength at very low levels of deformation, up to 20 mm. For lower class forest roads, ruts of 50-100 mm are accepted before a pavement is considered failed.

A number of in-situ alternatives have been developed over time and most still report the outcome as a CBR value. The laboratory CBR tests are usually used as a control for field penetrometer determinations.

CBR test apparatus



A sample of soil is prepared by compacting it into a mould. A plunger is then pushed into the soil at a uniform rate, and the pressure dial measures the force. This force is compared to a Californian limestone standard and the result presented as % CBR

6.2.2 In-situ measurements of CBR

The aim of subgrade evaluation is to determine a subgrade CBR value for the density and moisture conditions that are expected to prevail



in service. The procedure used is influenced by factors such as the importance of the road, and the amount of experience the designer has had with similar subgrade material in similar locations and environments.

In variable soil conditions more measurements are warranted. A design CBR must take into account the changes in topography, drainage and soil type along the road. Correct documentation of the changes in soil type and CBR sample positions will provide accurate information for the subsequent pavement design.

For lightly trafficked roads, or where subgrade and climatic conditions are similar over large areas, extensive investigations might not be warranted if the road designer has considerable

expertise and experience. However, it is still important to formalise the process and record the outcome. For example, the test might be primarily through visual inspection of soil samples to determine its uniformity with depth, and call upon supplementary tests with the dynamic cone penetrometer or impact hammer for weak areas.

Dynamic cone penetrometer

The dynamic cone penetrometer is an instrument that drops a standard weight a fixed height to drive a small cone into the ground. The incremental changes in depth are correlated to CBR measures. The dynamic cone penetrometer permits the measurement of CBR through to a depth of 800 mm, or deeper if extension rods are used. As such, it is an excellent tool to use prior to road



Above: A cone penetrometer being used. Right: The chart showing the number of blows to reach a given depth, overlaid with the estimated CBR value

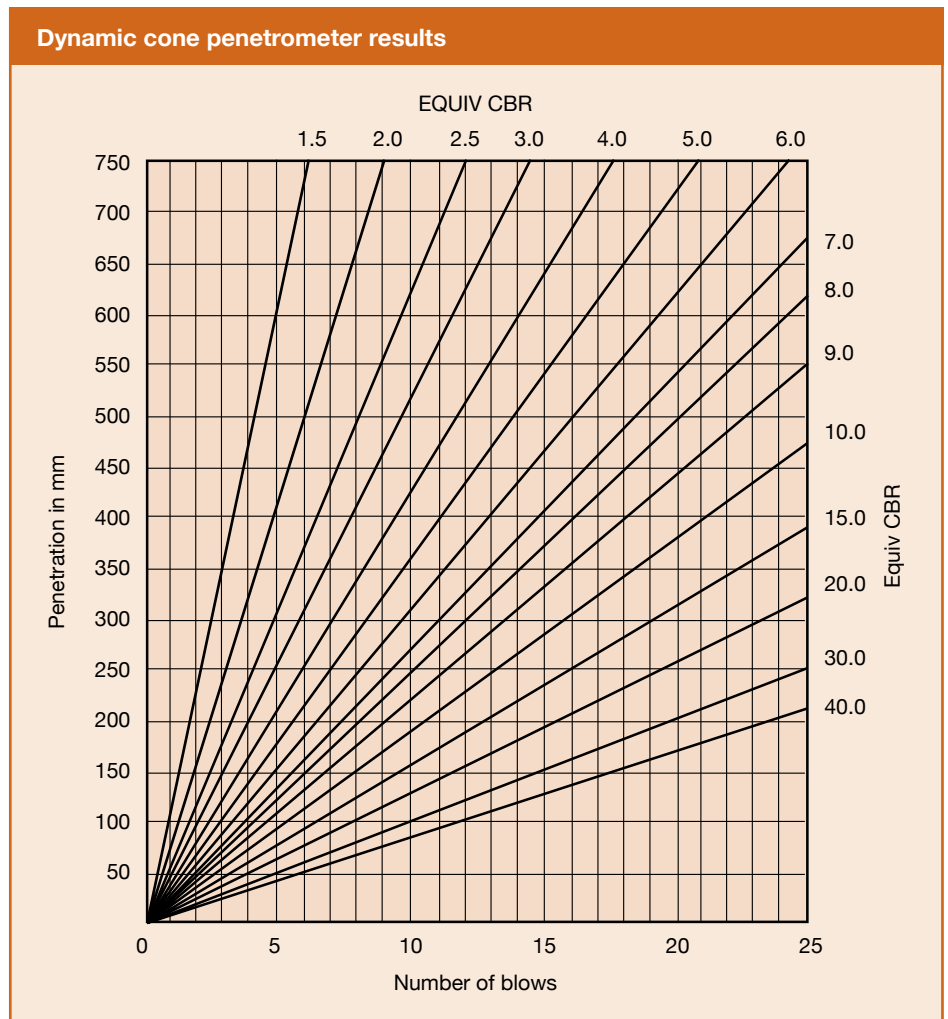

6. Pavement design, subgrade preparation, pavement construction – continued

construction to ascertain the subgrade strength below the surface where the road will be built.

From the CBR profile, variability of the subgrade material properties can be determined. The dynamic cone penetrometer test is most reliable in fine-grained soils. High subgrade CBRs, obtained from this penetrometer test in sands and gravels, should be further checked using laboratory testing or in-situ CBR equipment. The use of a cone penetrometer for the measurement of CBR in soils with a CBR < 3% will give unreliable results. This is due to the tendency of the penetrometer to sink into the soil under its own weight.

The graph on page 99 can be used to determine the CBR value of the subgrade material from the blows per mm ratio obtained from the penetrometer tests.

Impact soil test (Clegg Hammer & Loadmaster)

The impact soil test is a dynamic test procedure using a falling weight dropped directly onto the pavement. An internal accelerometer measures the rate of deceleration. The peak deceleration of the compaction hammer is directly related to the resistance offered at contact. This resistance results from the stiffness and shearing resistance of the material. Several dynamic falling weight apparatuses are available, including the Loadmaster and the

Clegg Hammer Impact Soil Tester.

From various comparison studies, it has been shown that there is a correlation between the impact test results and the CBR of the material, although this relationship varies with soil types. For example, for the Clegg Hammer, a useful starting point is the form $CBR = 0.07 (IV)^2$, where $IV = \text{Clegg Impact Value}$. Although this relationship must be used with some caution, the impact test procedure has wider applications including checking variations during construction, and monitoring changes over time.

For further information on the equipment and test procedures consult the manufacturers or suppliers of the soil impact test equipment.

6.3 Determining pavement depth

Knowing both the designed traffic loading, in terms of equivalent standard axles (ESA), and the Californian bearing ratio value for the subgrade, means that design charts can be used to provide an indication of pavement depth requirements. A thicker pavement layer distributes stress over a larger area, enabling the subgrade to withstand larger loads.

The standard chart used for public road design has two shortcomings for forest roads. It is based on very high volumes of traffic in excess of 10,000 ESA, requires a pavement with minimum CBR of

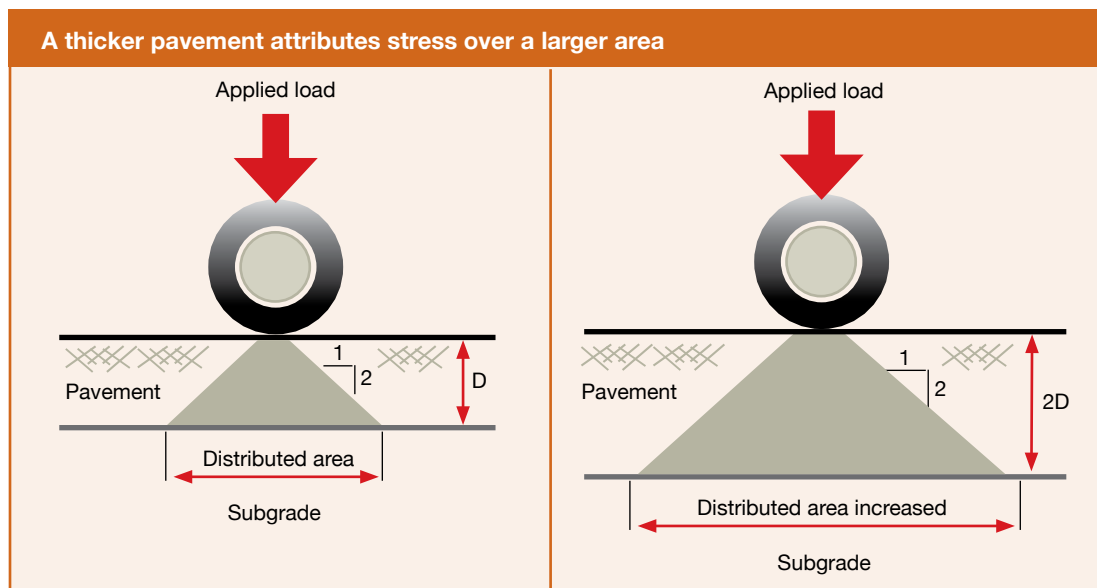



CBR versus pavement thickness

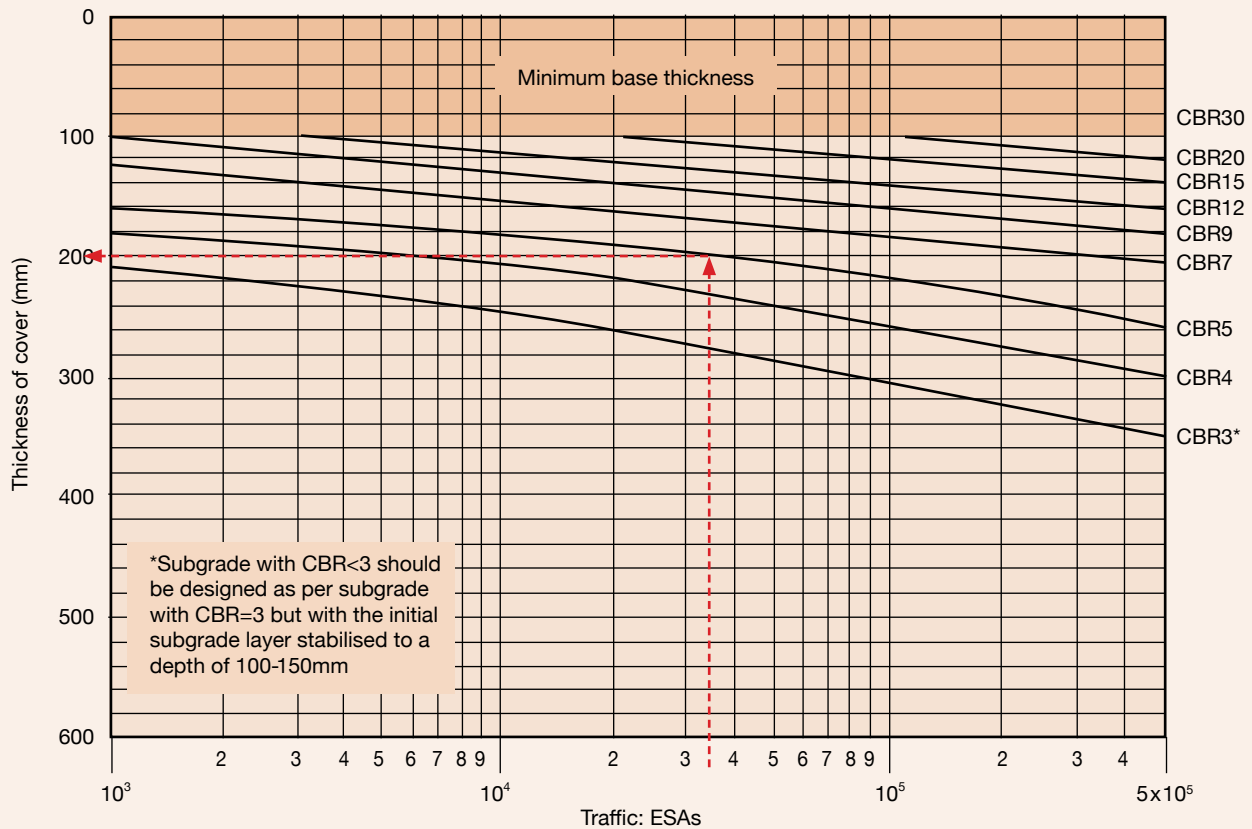

Source: *Guide to the design of new pavements for light traffic, APRG Report 21, 1998*

80%, and provides a 90% confidence that the road will not fail in its design life (ARRB 2010). Traffic will be less for most forest roads and the pavement material will be weaker (CBR approximately 40%). Also, 80% confidence is considered fit for purpose for forest roads. Small failures, such as rutting, can be readily remedied through maintenance and will not stop typical forestry traffic. As such, the chart presented in the ARPG report (1998) is most suitable for forest road design.

Example: CBR design chart

A subgrade soil for a new forest road has been assessed to have a saturated strength of CBR=5. Saturated strength has been used as the road is planned for use during the wet season. The design ESA is 35,000 (from previous example). Enter the graph at $ESA = 3.5 \times 10^4$ and draw a line vertically until the CBR=5 line is intercepted. Draw a second line horizontally from this point to intercept with the horizontal axis. The resulting value on the horizontal axis is the required pavement depth. For this example, a minimum compacted pavement depth of 200 mm would be required.

Central tyre inflation (CTI)

Central tyre inflation (CTI) assists truck performance on forest roads through improved gradient, traction and handling. CTI also helps to maintain the pavement. In critical areas with steep adverse roads or poor pavement properties, roads may need to be designed solely for CTI trucks.



Central tyre inflation on the drive wheels

6. Pavement design, subgrade preparation, pavement construction – continued

6.4 Pavement material properties

The design process outlined above, assumes a strong aggregate material being used for the improvement layers. In many forestry applications, the roads consist of just a single pavement layer, known as an improved layer. Aggregate is spread and compacted and, as long as the aggregate is well graded with an appropriate proportion of fines, can develop a good pavement that concurrently works as a base course and surface course. On steep adverse sections, where traction is critical, an additional layer of crushed running course may be spread.

Material properties and characteristics are the most important factors when determining which material to use for a pavement. Other factors which must also be considered are cost, availability and environmental factors. Often the material is selected as a compromise between achieving the desirable properties and acceptable overall costs. Ideally, the best aggregate is well graded, has numerous broken faces, is hard, and has a low water absorption rate.

The material property which has a significant influence on pavement strength, compaction and longevity is the particle size distribution. Particle size distribution is described in terms of standard particle size classifications. For example, gravel, sand, silt and clay or alternatively, the fractions which pass various sieve sizes. A soil-aggregate consisting of a well-graded gravel sand mixture with a 10-15% proportion of fines (particles smaller than 0.06 mm diameter) will usually be the most desirable material. The large gravel provides structural strength, the finer gravels and sands fill the voids between the larger particles to provide high density and to maximise frictional interfaces, while the fines combine with water to bind the aggregate together. Note that it is desirable for the fines to have some plasticity (Plastic Index between 3 and 10) to improve binding capacity.

The table on the right right shows the main characteristics and workability properties of three materials: A good particle size distribution material, a coarse material



Well-graded material being placed onto the subgrade to form the improvement layer

lacking in fines, and a material with excess fines. The coarse material lacking in fines will be porous and unstable, which makes it unsuitable for a base course or wearing course, but ideal as a sub-base material.

Aggregate mix properties and workability

Type of Mixture	Coarse stone low fines	Well-graded coarse to fine	Excess fines
Compaction	Difficult	Moderate	Easy
Flexibility	Relatively stiff after compaction	Moderate	Relatively pliant
Stability	Variable	Good	Fair
Frost	Not affected	Susceptible	Very susceptible
Drainage	Good	Low	Variable
Effect of water saturation on strength	Not much	Moderate	Very significant strength loss
Chemical stabilisation	Not very suitable	Suitable	Very suitable
Dust	Low	Moderate	High
Roughness	High	Moderate	Variable
Capillary effects	Very low	Beneficial	High suction potential instability

Source: New Zealand Supplement to the ARRB Unsealed Roads Manual

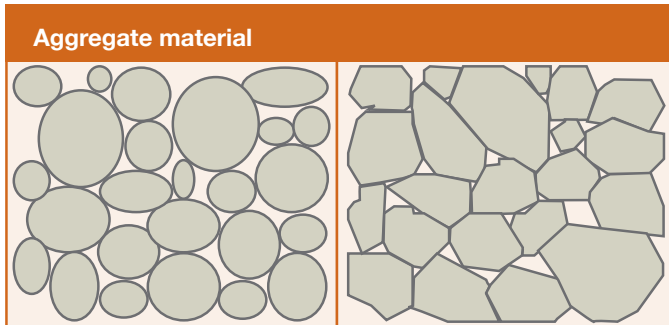

Surface contact is increased with broken faces

Aggregate material gains some of its strength from surface friction between the particles. An increase in the number of broken faces will increase the surface contact area between the aggregate and increase the load bearing capability of the material.

Soft material, which is easily broken, will quickly deteriorate under the constant motion of the traffic loadings. This results in degradation of the pavement material, which lowers the bearing capacity.



Typical small forest quarry

The environment can affect both the subgrade and pavement materials. Changes in moisture and temperature can influence the properties of a material, and, therefore, the overall performance and serviceability of a pavement structure. Pavement design must take into account the moisture and temperature, both averages and ranges, which the pavement and subgrade will encounter during service. The significance of environmental effects will depend

Pavement material properties and characteristics					
		Gravels	Sands	Silts	Clays
Water content	Dry	Little effect on strength	Low strength unless well graded	Low strength	High strength when compacted
	Moist	Little effect on strength	Improves cohesion	Improves cohesion	Improves cohesion of uncompacted clays. Reduces strength of compacted clays
	Wet	Little effect on strength	May lose strength due to particle separation	Very weak. Water lubricates and separates particles.	Weak. Water lubricates and separates particles.
Density	Low	Low strength	Low strength, unless confined	Low strength	Low strength
	High	Increased strength by improving interlocking of particles	Increases strength by improving interlocking of particles	Increases strength	Increases strength
Particle size distribution	Poorly graded	Lower strength due to less interlocking	Low strength		
	Well graded	Increases strength by better interlocking of particles	Increases strength		
Particle mineralogy and shape		Strength reduced by weak or weathered particles	Strength reduced by weathered particles, but these may improve grading	Shape and mineralogy may influence elasticity	May have significant effect on plasticity and shrinkage

6. Pavement design, subgrade preparation, pavement construction – continued

on the materials selected for the pavement, and the period during which the heaviest loads will use the pavement.

Aggregate material, which absorbs water from the environment, will generate problems with shrinkage and swelling, as well as freezing and thawing during winter periods. Freezing causes not only a build-up of ice on the running surface of the pavement, but also expansion within the aggregate material. This causes material to fracture and break down into fine material with a decreased load bearing capacity.

6.4.1 Aggregate selection

Several factors determine aggregate selection. These include:

- Material availability
- Cost of transportation
- Structural properties
- Durability
- Workability
- Royalty, purchase or extraction costs.

Selection and use of local pavement materials is a key factor in minimising the cost of forest roads. Often in forestry, the cost of transporting high quality aggregate may be prohibitive. It may be better to use a local, poorer quality material which requires less transportation. However, additional quantities of the poorer quality material will be needed to improve the design performance. Be careful, as substandard quality material requires careful consideration to determine pavement depth, load bearing and load distribution properties. Additional pavement depth of stabilised material may be required. An option is to use the higher cost material for the upper pavement section if required.

In some regions of New Zealand, there are multiple options for sourcing material. For example, in parts of Hawke's Bay there is a choice between red metal (old river cobbles), weathered greywacke and limestone all within close proximity. Further north in the Gisborne region, many forests do not have an in-forest metal source, and metal is often carted long distances.

The following are sources of potentially suitable local pavement materials:



An ideal situation – a large in-forest aggregate source

- Granular material exposed in cuttings during the formation of the road. This may consist of weathered rock that can be easily excavated or alluvial gravels
- Borrow pits established near the road formation that contain suitable granular material. Where deposits of suitable material are found, the establishment of borrow pits can significantly reduce the cost of pavement surfacing
- Extraction of gravels from rivers. This will usually require resource consents, and may have specific conditions. However, in some circumstances, removal of gravel from an aggrading river channel is beneficial to river management, and may provide a useful local source of pavement material
- Establishment of a forest quarry. This may require geological investigation and application for consents. However, a quarry



producing suitable pavement material within a forest can significantly reduce the cost of forest roading

- Blending of materials from off-site with on-site materials. A granular material that is available on-site may be lacking in a particular particle size and could be improved by blending this with a complimentary material from off-site. For example, crushed bluestone aggregate imported from a quarry can be blended 50/50 with lime rock from local deposits to produce a road surfacing aggregate that will bind well. It will also have much better durability and strength than the lime rock would have if used without blending
- On-site crushing of suitable material. If suitable source material is available in a borrow pit, quarry or from extracted river gravels, the suitability of this can be significantly improved by arranging an on-site crushing operation using a mobile crushing plant
- In-situ crushing of material. A simple towed steel grid roller can be effective at crushing larger aggregate particles that have been placed on a road pavement sub-base layer from a weathered rock quarry face. Mobile in-situ crushing equipment can crush and blend aggregate that has been placed on the road pavement. This enables rock or gravel from local sources to be spread on the road pavement and then processed to a suitable



Crushed concrete may be a non-traditional alternative where there is a close source. Two screened grades can be seen

particle size distribution for compaction into a pavement layer

- Other creative options that could include crushed concrete, but the reinforcing steel needs to be removed as it is a hazard.

6.5 Compaction of subgrade and pavement

Compaction is an essential component of earthworks; it should be an integral part of both the subgrade preparation, as well as the placement of the improvement layer. All fill material should be compacted; correct compaction of subgrade and especially fill material will ensure that natural settlement is minimised increasing its stability and life. Uncompact fills are likely to be prone to vertical settlement of the ground surface which may lead to construction or environmental issues. Weak soils are greatly strengthened with compaction.

Compaction consists of reducing the apparent volume of the soil by expelling air through mechanical action. Compaction reduces the voids, thus increasing the soil density, and therefore increasing its bearing strength. This also leads to less water absorption.

Often there will be more than one soil type on a construction site. Consideration will need



Well-prepared, compacted and shaped subgrade ready for placement of aggregate

6. Pavement design, subgrade preparation, pavement construction – continued

to be given to how best to manage the range of soil types that may be present. Fill design determines how soils will be mixed (and behave), depending on the site geology and geography, and the contractor's construction methodology. It is important that the suitability of the in-situ soils be assessed against the fill requirements before earthworks begin. Some material is not acceptable as structural or load bearing fill. A good reference is *Methods of testing soils for civil engineering purposes – Part 4 Soil compaction tests* (NZS 4402.4.1:1986.)

6.5.1 Optimum moisture content

Moisture content has a significant impact on the efficiency of compaction. A soil that is too dry does not have sufficient inter-particle lubrication for the soil to pack into a dense configuration, whereas a soil that is too wet, will either be prevented from dense packing, due to the presence of water within the pore spaces of the soil matrix, or will cause the fines to be 'pumped out' during the compaction process. Before the compaction process begins, the layers should be checked to ensure that the moisture content is uniform.

Through a series of lab compaction tests, the effect of moisture content on density is readily shown, as is the concept of an optimum moisture content (OMC) at which a soil will

achieve maximum dry density for a given compaction effort.

For example, in the chart below the OMC occurs at 18% moisture content and results in a maximum dry density at 1.75t/m³. The OMC for each soil varies and needs to be determined by laboratory analysis. Note that the dry density achieved when the soil is dry (13%) is no better than that achieved when the soil is saturated (22%).

A simple in-field approximation of OMC is that the soil should be moist, but not wet, when compacted. A rough check for most materials is to squeeze a lump in the hand and, if it just holds together when pressure is taken off and the material does not stick to the fingers, the water content will be approximately at optimum. If a soil is too dry, add water with a water truck. Compaction is impossible if a soil becomes too wet. In this situation, stop compaction and wait until the soil has time to dry. Options are to provide good drainage and daylighting, or alternatively, apply lime and/or cement to assist drying of a wet subgrade.

The benefit of compaction at the OMC is that the soil will be at its densest, which provides highest saturated strength and reduces water infiltration. For example, the subgrade soil in the figure below exhibits high strength when built at a low

moisture content (CBR=15 at 14% moisture content), but rapidly loses strength upon becoming saturated reducing to CBR=3 due to low dry density. This occurrence is common, as many forest roads are constructed during the dry summer, only to fail when they become saturated during the following wet winter. The same soil constructed at OMC will exhibit lower strength during construction (CBR=9), but will retain higher strength when saturated (CBR=6). Note that when compacted at OMC this soil will increase its strength as it dries, exceeding CBR=15 when dried to 14% moisture content.

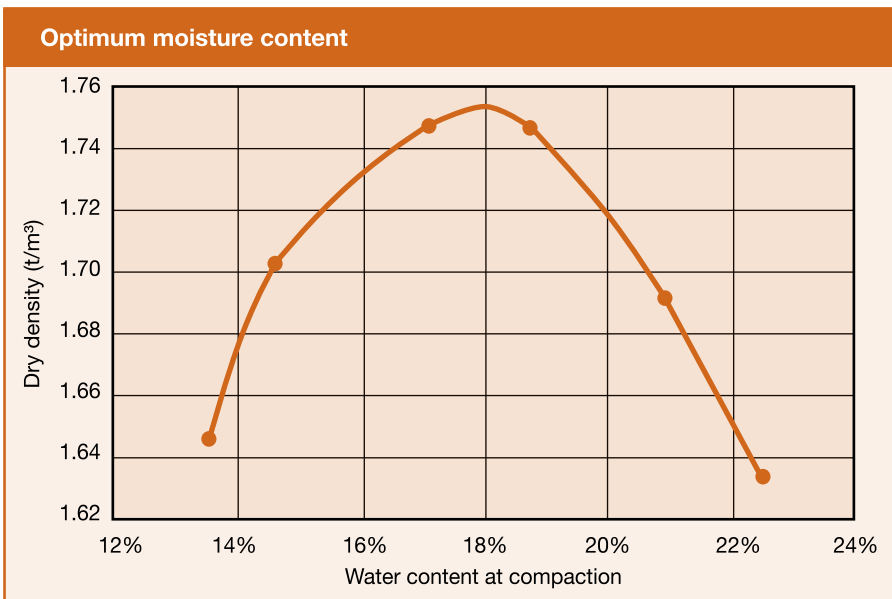

Optimum moisture content for an East Coast low plasticity clay soil

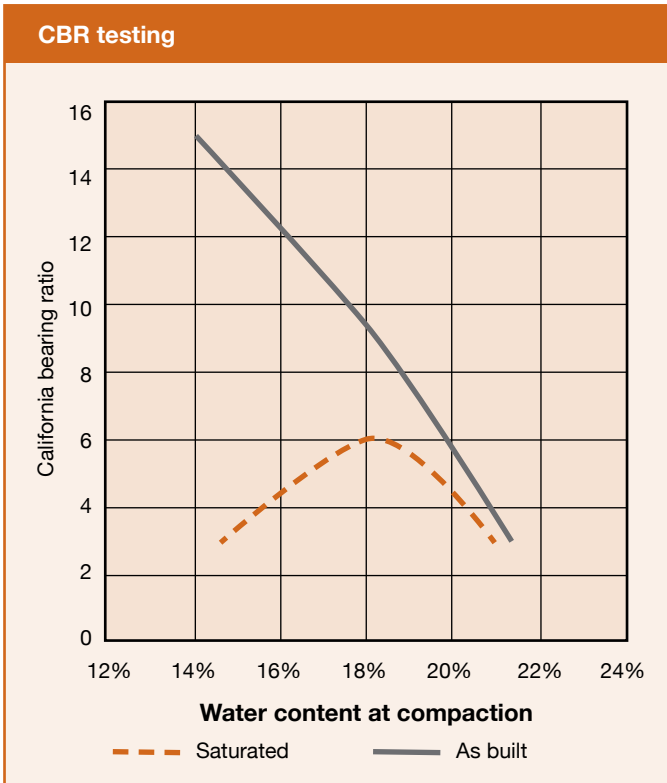

Laboratory results from CBR testing of an East Coast lean clay soil

Granular fills are normally suitable for fill construction, as strength is usually adequate over a range of moisture conditions. Granular soils are free draining and are less likely to be above their OMC for compaction. Significant volumes of water can be added to granular



Compacting fill material around a culvert is important to avoid failure in the long term

pavement layers to aid compaction. This is particularly important when compacting aggregate layers. Compaction of granular soils can be carried out with static compactors, that simply apply weight and tend to compact from the bottom of the layer up; vibratory compactors, that use a mechanical action to consolidate soil particles; and impact compactors, that use a high-amplitude thump to compact material.

Compaction is not only important for subgrades and roads, but also around culverts to prevent the fill material from becoming saturated and failing.

6.6 Compaction equipment

There is a wide variety of compaction equipment available. Compaction is usually achieved using a vibrating or non-vibrating steel drum roller, a pneumatic-tyre roller, a sheep-foot roller, or a grid or cleated roller. Each is best suited to specific applications. A large steel drum vibratory roller is often considered the best for general purpose use. The range of material that can normally be compacted economically with each type of roller is shown below. Compaction in cohesive soils are best achieved by impact and weight to increase the soil density. Impact is required to break down the cohesive bonds to enable the soil to become denser.

Kneading compactors with high point loads, such as sheep and pad foot rollers, are required for cohesive soils. Compactions in granular soils are best achieved by vibration. The options are static compactors that simply apply weight and tend to compact from the bottom of the layer up, vibratory compactors that use a mechanical action to consolidate soil particles, and impact compactors that use a high-amplitude whack to compact material. In addition to their normal compaction applications, smooth drum-vibrating rollers and pneumatic-tyre rollers are used as finishing rollers for clay and clayey sand subgrades, as sheep-foot and tamping rollers do not produce a smooth surface. A pneumatic-tyre roller may be used to seal off earthworks from rainwater.

The range of compaction equipment available for subgrades and pavements, and the situations for which they are best suited, is described on page 108.

6. Pavement design, subgrade preparation, pavement construction – continued

Compactor selection depends on the material									
Heavy clay	Clayey sand	Clayey gravel	Paving gravel	Silty sand	Rock & sand				
Sheep-foot									
	Wedge foot								
		Steel cylinder							
		Vibrating smooth drum							
Vibrating sheep-foot									
		Pneumatic-tyred							
		Grid							

Smooth-wheeled rollers

Used for the compaction of crushed rock, gravels, sands and other granular materials. In general, they're not best suited to silts or clays but they can be used for compaction of these materials. The performance of smooth-wheeled rollers depends on the mass of the roller, and the width and diameter of the rolls. The compaction depth of the layer for satisfactory results depends on the mass of the roller, but can be up to 450 mm for embankments, and 150 mm for subgrades. Safety issues need to be considered when using these rollers on wet roads with crossfall.

Multi-tyre, pneumatic-tyre rollers

These rollers are usually self-propelled, with smooth tyres on two axles in an offset arrangement, so that the wheels on one axle track are in the gaps between the wheels on the other axle. The mass of the roller can be increased by attaching ballast, and the tyre pressure is sometimes variable. Fine soils with little or no cohesion, for example silts, sandy silts, well-graded sands, and clay soils, compact well when using these rollers. The layer thicknesses should not exceed 230 mm when compacted, and the performance of the roller is a function of tyre pressure, tyre contact area and weight.

Heavy pneumatic-tyre rollers

These rollers have four equally-spaced independently suspended tyres and can be ballast loaded up to a total mass of 50 tonnes. They are usually towed, and are suitable for similar soils to the multi-tyre pneumatic-tyre rollers, as well as for gravels and finer silts. The difference between these and multi-tyre pneumatic-tyre rollers is that the heavy pneumatic-tyre rollers can compact deeper layers, and the surface density achieved is greater.

Sheep-foot rollers

The sheep-foot name comes from the tapered prong feet on the steel drum of these rollers. They can be either towed or self-propelled, and their mass can usually be increased by filling the drum with water, or with sand and water.



Smooth-wheeled roller



Sheep-foot roller preparing the subgrade of a new forest road

Performance is best on cohesive soils at, or drier than OMC. During use these rollers will tend to 'walk' out of the fill as compaction occurs and the feet ride on the compacted surface.

Tamping-foot rollers

These are similar to sheep-foot rollers however the feet are wider, shorter and closer than sheep-foot feet. They are also often diamond-shaped. They can be self-propelled or towed and will compact a wider range of soils than sheep-foot rollers, including silts, and rock fragments, but not uniform sands.

Grid rollers

The rolls on grid rollers are manufactured from a mesh of usually 20 mm diameter bars spaced 100 to 150 mm in both directions. Alternatively, they may be smooth drums with a pattern of square holes formed in the surface. They are particularly useful for scoria-type fill (random mixtures of large and small particles, usually angular and fairly soft). Their particular use is in breaking down oversized stones and forcing them below the compacted surface.

Vibratory compactors

These rollers have a rotating eccentric weight to produce a vertical acceleration, which helps to compact the material. They have various types of drum, such as smooth wheel and sheep-foot.

The force applied to the soil is proportional to the acceleration in the vertical direction, so they have a better performance than static rollers. Vibrating rollers are suitable for compacting non-cohesive soils, compacting from the base up towards the surface, which always leaves a layer of looser material at the surface. This is caused by the bouncing effect among the particles of that layer as the vibratory effect is transferred downwards. This can be easily overcome by using a compactor with medium to low weight and low amplitude, or by turning off the vibration.

The primary characteristics of vibratory compactors are the weight of the vibrating component (drum or plate), the weight applied through the component to the ground, and the frequency and normal amplitude of the vibration. Heavier weight rollers with high amplitude and relatively low frequency (200-1800 vibrations per minute) can compact very thick lifts (0.5 m) in some granular materials, and up to 300 mm in clay materials.



With less weight, lower amplitudes and generally higher frequencies, a reduced layer thickness can be compacted. Frequency is not generally critical, except that the higher it is, the fewer passes are required, and the faster the compactor can travel to obtain optimum compaction per pass.

When using a vibratory compactor, a pattern

6. Pavement design, subgrade preparation, pavement construction – continued

must be adhered to, to avoid gaps in the pass coverage. It is also important not to over compact the material. When the drum bounces on the hardened surface, a distinct ‘ringing’ noise can be heard. This can cause damage to the roller, and it will also reduce the density of the material. Therefore, for very thin layers (30 mm), particularly of granular or sandy materials, two passes may be sufficient, and four passes may be too many.

Large dual vibrating drum rollers

Granular materials of up to 250 mm can be successfully compacted in four to 10 passes with these rollers, providing they are correctly calibrated to obtain the most appropriate weight, frequency and amplitude. To complete the compaction, it is generally necessary to operate the roller without vibration for two to four passes to consolidate the surface.

Earth vibratory compactors

These are generally of the large single vibratory drum type with large rubber driving wheels. They are used for difficult terrain and thick layers of earth. Some rollers of this type are fitted with rubber coated drums, which have proved effective for the compaction of chips in chip seal construction.

Powered static rollers

Powered static rollers compact material by pressure only. Loose layer thicknesses of 100 to 150 mm of material are compacted at any one time, and a large number of passes are generally required to obtain full-depth compaction. These rollers compact from the top down. Only the first 50 mm of material is usually compacted by the first four or five passes, and a further 20 or 30 passes may be necessary to complete compaction. One major disadvantage in the use of these rollers is the crushing effect on the upper compacted material, which can produce excessive fine material, affecting the quality of the base course. Various types of rollers are available, including tandem and three steel wheeled 8 to 12 tonne rollers, sheep-foot and grid rollers which are used for bulk material compaction.

Track rolling

Track rolling is commonly used by forest road contractors to compact road and landing surfaces. However, the tracks for construction equipment are designed for low ground pressure. By definition, this means that tracked equipment is poor for compaction. Time and money spent track rolling would be better invested into dedicated compaction equipment. However, track rolling is probably better than nothing and may reduce surface scour.



Track rolling will produce an attractive surface finish but has negligible compaction effect

The range of compaction equipment for hand-held, localised applications – such as culvert installation – are described below.

Power rammer (oscillating foot compactors)

These small compactors, usually operated by hand, have a relatively low output in terms of volume of compacted soil/hour. Generally, these compactors are used for compacting material which has been backfilled into excavations in confined spaces, such as in trenches and around culverts. Compaction of material using a power rammer should be completed in layers. For granular soils, layers should not be more than 230 mm thick, whereas for cohesive soils, layers should be no more than 200 mm thick. Power rammers have a vertical movement ranging from 12 mm to 150 mm at frequencies of 20 to 200 blows per minute.

Vibrating plate compactors

These compactors are available in weights ranging from 50 to 150 kg and have an operating frequency



of 400 to 10,000 vibrations per minute, with low amplitude. Vibrating plate compactors are used to compact layers of 75 mm-110 mm compacted thickness of most materials, and are ideal for small areas (up to 20m²) requiring 4-6 passes for optimum compaction.

Single drum vibratory rollers

These compactors are hand-operated, and are ideal for granular materials with compacted layer depths of up to 120 mm with four to six passes. They operate in the high frequency, low amplitude mode.

6.6.1 Compaction process

To be effective, compaction needs to be done correctly. The layer thickness should be appropriate to the type of material being placed, and the type and capacity of the compaction equipment being used. The table below provides indicative compaction requirements for various types of fill material. Compaction becomes ineffective over 300-400 cm.

The following will help provide additional operational guidance:

- The subgrade should be even and have the required cross-section shape with crossfall, and where necessary, superelevation on corners. Re-shape with a grader or excavator if compaction changes the subgrade shape, and then re-compact. Do not use the aggregate layers to create crossfall and to even out variations in the subgrade shape. It is an inefficient method, and aggregate is usually the most expensive component of the road construction

- Dispose of non-compactable, unsuitable or excess road construction material where there is a low risk of movement
- All culverts and ditches should be in place. Installation of any culverts after the placement of pavement aggregate should be avoided. Typical subgrade compaction consists of six passes of a sheep-foot or steel drum vibrating roller of at least six tonne static weight. Effective compaction is not possible if the moisture content of the material is too far from the optimum moisture content. That is, too dry is as bad as too wet
- Rolling should commence at the outer (lower) edge of the pavement and progress towards the centreline, or upper edge, if superelevated. Rolling with the passes progressing towards the lower edge will cause material to move downhill, resulting in loss of shape
- Fill batters should be overfilled to support earthmoving equipment and to allow the compaction plant to compact the full width of the design cross section, and then trim back to the design batter slope as the fill is built up. This will ensure the full width, including the outer edge of the fill, is effectively compacted
- A forward and reverse pass is made over the same section of pavement before moving to the adjacent section. It is important to check that this is done at the edges of the pavement. When changing direction, the roller should be on the previously compacted section

Typical compaction requirements for fills				
Material type	Preferred type of compaction	Layer depth mm		Number of passes
		Subgrade	Fill	
Gravel/sand	Smooth drum	200	400	4 – 6
Clayey gravel/sand	Sheep-foot	150	300	4 – 6
	Pneumatic Tyred	150	300	6 – 8
Clay/silt	Sheep-foot	250	200	6 – 8
Crushed rock (pavements)	Heavy smooth drum	125		6

6. Pavement design, subgrade preparation, pavement construction – continued

- An overlap of up to 500 mm over the previous pass to ensure complete coverage should be completed
- A space of 200 to 300 mm should be left on the outside edge of the pavement if this is unsupported. Rolling of this section should take place later with a lighter roller.
- Vibrating rollers should have the vibrator turned off when the roller is stopped or turning
- Rollers jolting during reversing can encourage surface roughness, as can sharp turns or changes in direction, and therefore this should be avoided
- Static drum rollers should have the drive wheels leading on the initial pass to avoid pushing material ahead of the drum
- Best compaction can be achieved with a vibrating roller by using a sequence of a non-vibrating pass, followed by several high amplitude passes, and finishing with low amplitude passes.

Subgrade strength needs to be identified to make sure that the compaction is effective, consistent across the area, and to design standards. Decide on the specific tests and testing frequency during the planning and design phase. These should reflect the scale and complexity of the earthworks, and the consequence of the fill failing.



Compaction needs to be done in layers

The following field-testing equipment is considered suitable for compaction testing on most forest earthworks projects:

- Scala penetrometer – strength testing in cohesionless soils. Results are converted into an ‘inferred CBR’
- Shear vane – strength testing in cohesive soils. The results are expressed in kPa
- Clegg Impact Test – testing surface hardness or stiffness. The result (impact value) can be used as an indication of compaction but is not a direct measurement. Impact values can be converted into an inferred CBR (Inferred CBR = $0.07 \times (IV)^2$)
- Nuclear densometer – testing of water content and percentage compaction (if MDD target is provided).

The table on page 113 shows the recognised methods for testing the quality of fill materials and construction.

6.7 Pavement construction

The key to the successful application of aggregate is having a well-prepared subgrade, using the right aggregate at the right thickness for the job, and applying it with skilled operators in the right weather conditions.

The subgrade is the road foundation. Make sure this is done well. Use a grader to shape the road. Eliminate depressions and holes, and get the camber right on corners. Metalling is an expensive way to solve poor formation practices. If soft spots are found, dig these out and replace with quality fill. If needed, use geosynthetic fabric as a barrier in weaker subgrades.

Pavement aggregate layers should be placed in a thickness that is not less than 2.5 times the maximum size of the aggregate, but generally not greater than 300 mm thickness in a single layer. For example, a GAP65 aggregate can be placed in layers from 160 mm to 300 mm thickness, whereas aggregate containing quarry rock up to 120 mm particle size should be placed in 300 mm thick layers. Placement of aggregate that has particles exceeding 150 mm in diameter on the pavement should be avoided, except where it is intended that this



Recognised methods for testing the quality of fill materials and construction		
Parameter	Test description	Test method
In-situ density	Rapid	NZS4407:1991, Test 4.2.1 (Nuclear densometer direct mode) NZS4407:1991, Test 4.2.2 (Nuclear densometer backscatter mode)
	Fully specified	NZS4402:1986, Test 5.1.1, 5.1.2, 5.1.3 (Sand replacement, balloon densometer or core cutter)
MDD & OMC determination	Standard compaction	NZS 4402:1986, Test 4.1.1
	Heavy compaction	NZS 4402:1986, Test 4.1.2
Strength	Scala penetrometer	NZS 4402: 1986, Test 6.5.2
	Pilcon shear vane	NZ Geotechnical Society Inc <i>Guideline for hand held share vane</i>
	Clegg impact test	ASTM D5874-95
Permeability	Laboratory triaxle permeability	Based on Head, Vol.3, 1988, Section 20.4.2
Solid density	Solid density	NZS 4402: 1986, Test 2.7.1
Moisture content	Moisture content	NZS 4402: 1986, Test 2.1
Particle size distribution	PSD wet sieving	NZS 4402: 1986, Test 2.1
	Hydrometer	NZS 4402: 1986, Test 2.1

material will be in-situ crushed with mobile crushing equipment.

The quantity of aggregate required to create each surfacing layer should be calculated before beginning the pavement spreading operation. This is to ensure that the required quantity is available, and to maintain sufficient quality control over the placement so that the required pavement depth is uniformly achieved. If this is not planned and monitored properly, local areas of reduced thickness may be present. These will reveal themselves as soft spots once the road carries heavy traffic in wet conditions.

Pavement aggregate volume requirements are calculated by using the following formula:

$$\text{Volume} = \text{Road length} \times \text{Pavement width (incl. allowance for shoulders)} \times \text{Thickness} \times \text{Compaction factor}$$

Example

A 1.2 km length of 3.5 m wide road with 0.5 m wide shoulders is to have a compacted pavement layer of 200 mm with an aggregate with a known compaction factor of 1.4.

$$\begin{aligned} \text{Volume} &= 1200 \times 4.0 (3.5 \text{ m plus } 0.5 \text{ m tapered shoulder both sides}) \times 0.2 \times 1.4 \\ &= 1,344 \text{ cubic metres (say } 1,350 \text{ cubic metres allowing for some handling loss)} \end{aligned}$$

The compaction factor is the amount that the aggregate will decrease in volume once it is compacted on the road. This will depend on the aggregate being used, but will typically be 1.3 to 1.5. For example, to get a 100 mm depth, between 130 mm and 150 mm will need to be applied. Once the required volume is calculated, the length of road that will be surfaced by each truck load should be calculated. This is then used as a guide for the operation to ensure the correct quantity is applied. For example, if you are putting a m³ of metal on a metre of road, and the truck carts 7m³, then the spread should be 7 m long.

Where a local aggregate is available at low cost, it is less important to monitor quantities because placing additional thickness in some areas has minimal impact on total road cost. Where pavement surfacing aggregate is being supplied from a quarry at some distance from the forest,

6. Pavement design, subgrade preparation, pavement construction – continued

It is especially important to monitor spreading rates and thickness. This can be achieved by marking the distance each load is to be spread over, and ensuring each truck operator spreads over this distance.

Pavement aggregate should be handled carefully to minimise the effects of segregation. Segregation is the separation of aggregate particles into size categories, and this occurs when aggregate is deposited in a stockpile or is bladed along the road surface. The fine particles tend to fall out of the aggregate mix, while the larger particles roll or are carried along by the blade. As a result, the outer edge of a stockpile will tend to contain a higher portion of large particles, and the bottom of the stockpile will have a higher concentration of fines. Where segregation is observed, the loading operation from a stockpile should include some re-mixing to achieve a uniform distribution of the entire particle sizes in the aggregate mix.

Unscreened metal can be dumped by the trucks then spread with an excavator. Oversized rock may need to be track rolled into the subgrade. The depth of the aggregate depends on the pavement purpose, and the subgrade strength. There are some rules of thumb like 'no less than 300 mm' or m^3/m of road. There are many opportunities to reduce the volume of aggregate on roads, especially if metalling costs are expensive. A good place to start is determining

the subgrade strength. Consider spreading a layer of crushed/screened aggregate to improve the running surface.

Aggregate spreading is best achieved through a spread from a moving aggregate truck. Dumping aggregate, and blading it into position with a small bulldozer, is likely to result in segregation,



Coarse stone with few fines





but this may be the only possible method if a course, uncrushed quarry rock is being applied to form a sub-base layer. A grader should be used to give the final shape. If the subgrade becomes saturated, the placement of pavement aggregate should be delayed until the subgrade material dries out.

On arterial and secondary roads, the placement of the final aggregate pavement layers should be accompanied by a grader and vibrating compaction equipment. The spread aggregate should be shaped by the grader to achieve the required crossfall and to remove ruts, with the minimum of re-working of the aggregate material to avoid segregation. Once the shape is correct, the entire pavement layer should be compacted as soon as possible with a minimum of four passes of a smooth steel drum vibrating roller of at least 6 tonne static weight.

On less critical secondary roads and spur roads, it may be unnecessary to grade and compact the pavement aggregate layers with a grader and vibrating roller. Spreading of aggregate, and reliance on truck wheel compaction, may suffice for these less critical roads. Typically truck wheels, although effective at compacting, cannot compact the crown of the pavement, so there will always be a portion of the pavement where, initially, water can penetrate to the subgrade. This is a problem if the road is to be used immediately, but not so much of a problem if the pavement is left for a winter to stabilise and seal.

Applying aggregate in poor weather conditions can lead to problems. Unsealed and wet aggregate spread on a wet subgrade could lead to major problems. However, in some situations it is better to take the risk on the metalling rather than leave an erosion-prone subgrade.

6.8 Weak subgrades

There are a number of options for subgrades that are weak and that cannot be strengthened by drying and compaction:

- Excavation of the unsuitable material to a depth, typically 0.5 m or more below the formation surface, disposing of this in a suitable fill area off the road formation, and importing alternative suitable formation

material to replace the reject material

- Mixing additional material with the unsuitable subgrade material to improve its consistency and strength. This is referred to as mechanical stabilisation
- Mixing in lime or cement stabilisation. This is referred to as chemical stabilisation
- Installing geosynthetic materials over the weak areas prior to or during placement of the pavement layers.

6.8.1 Corduroy

Corduroy is a valuable stabilisation alternative to geosynthetics, stabilisation chemicals and other products for forestry roads. Corduroy involves laying a mat of slash or logs on top of the subgrade. Aggregate is applied on top. To lay it requires considerable machine and labour time, and often uses wood that could otherwise be sold. However, corduroy may be the only cost-effective option for constructing roads over very weak and wet subgrades.

Using corduroy for forestry road or landing construction:

- Enables construction over very weak subgrades
- Has the potential to reduce the quantity of expensive aggregate required
- Allows the road to be used immediately after construction
- Minimises exposed earth that could erode (often when built on top of existing vegetation)
- Allows aggregate and corduroy to be recovered from roads that have been abandoned
- Provides a separation layer and improves drainage.

The major advantage of using corduroy is that it acts as a separator and a re-enforcer. The slash or logs separate a weak subgrade from the aggregate. This reduces any intermixing of the two, and ensures that the load bearing functions of the base course are performed without contamination from the weaker subgrade.

6. Pavement design, subgrade preparation, pavement construction – continued

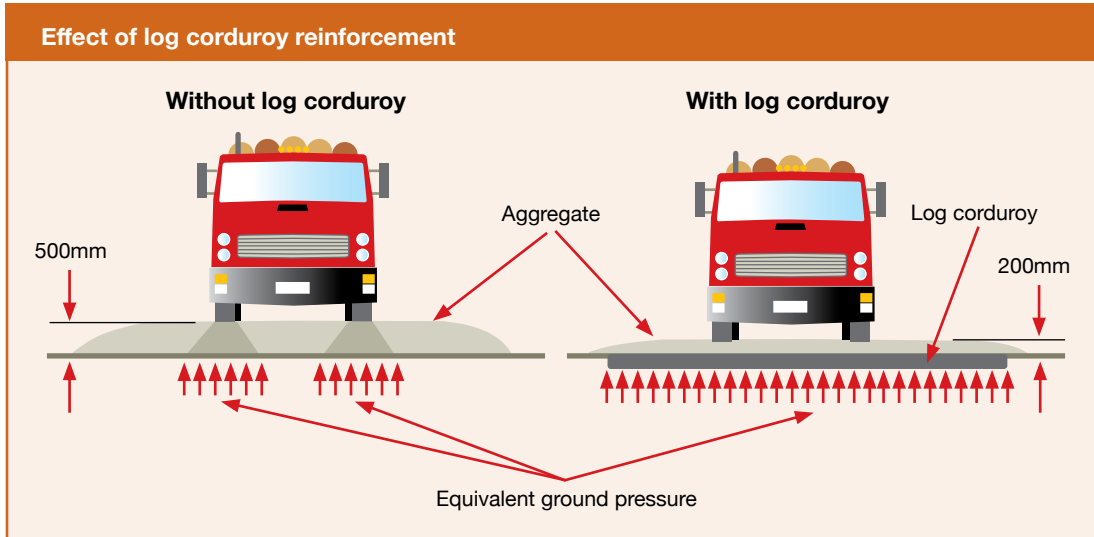

When aggregate comes into contact with the weak subgrade, it becomes slippery, which reduces the particle interlock (bearing capacity). Consequently, the road may fail.

The effect of corduroy laid across the subgrade is to spread the load. The load is redistributed over the whole width of the corduroy, effectively increasing its load bearing area. Reinforcement is greater with log than with slash corduroy since the logs act as a rigid platform.

Corduroy can improve drainage by providing a permeable layer between the base course and the subgrade. Water on the road surface percolates through the base course, and then flows along the corduroy plane, as shown below.



Slash corduroy provided truck access on a steep section of road after the subgrade failed

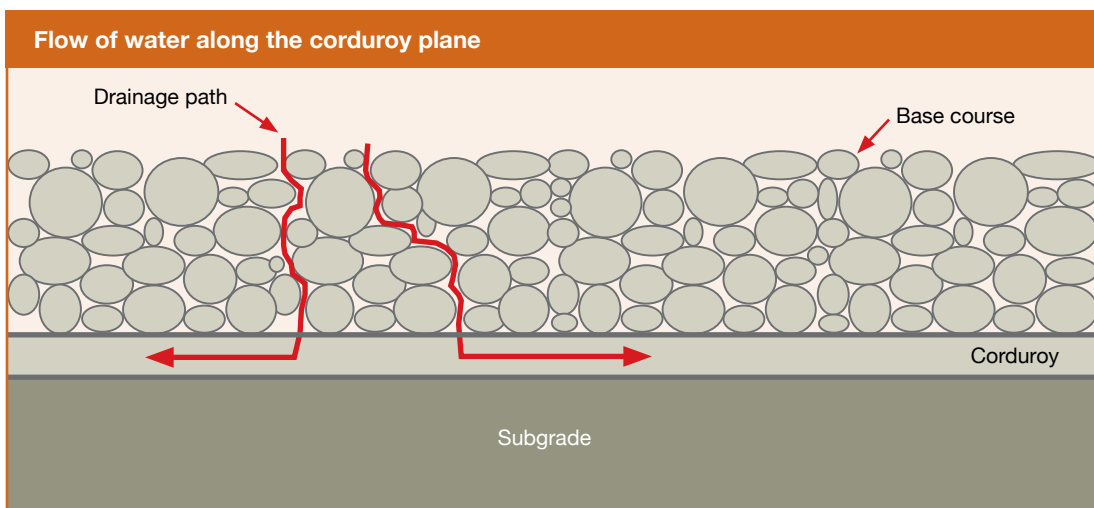



6.8.2 Geosynthetics and geogrids

The two main types of geosynthetics that may be used for forest roads are geosynthetic cloth and geogrids. These products have multiple uses, but they are most often used on roads with weak subgrades. They are an alternative to corduroying. Only use geosynthetics when a lower cost, equally effective method cannot be used or when a long-lasting solution is required. For example, a layer of corduroy may solve a subgrade stabilisation problem more economically than a geosynthetic; however, corduroy will decompose over time, and would be inappropriate for an important secondary or arterial road.

Geosynthetic cloth and geogrid work in different ways. Geosynthetic cloth provides a separation layer between the pavement and soft subgrade materials. This prevents fines from migrating and contaminating the pavement layer. Effective separation maintains aggregate layer strength and enables aggregate to be recovered for later re-use.

Geogrids are grids of high strength plastic that are laid between the subgrade and aggregate layers. The mesh interlocks with the aggregate to improve the shear strength of the aggregate layer.

The main benefit of these products is that they can significantly reduce the required thickness

of pavement (up to 40% in some studies), and can allow roads to be constructed on weak subgrade that would be otherwise unsuitable for construction. A cost-benefit analysis may be used to determine whether geosynthetic cloth or geogrids (or a combination of both) is suitable for a given road. Geosynthetic cloth and geogrids are non-biodegradable, so are well suited for roads that will be used for extended periods of time. Geosynthetic cloth and geogrids may be used in combination, with the grid overlying the cloth, for construction on particularly weak subgrade.



Geogrid laid on a subgrade prior to application of the aggregate layer

Geosynthetics can also be used as a drainage filter, restricting water movements into the subgrade or pavement. They also stop the migration of fine soil particles from aggregate material while under pressure from water. For example, a geosynthetic wrapped around coarse gravel that fills a drainage trench, allows water to pass across the soil/fabric interface while retaining soil particles. Some non-woven geosynthetics are quite thick and can pass water along their length as well as across their thickness. This improves drainage of excess water pressure in the soil.

Geosynthetic cloth and geogrids are relatively easy to use; however, correct application often requires specialised design input to determine



Geosynthetic cloth being used as a separation layer

6. Pavement design, subgrade preparation, pavement construction – continued

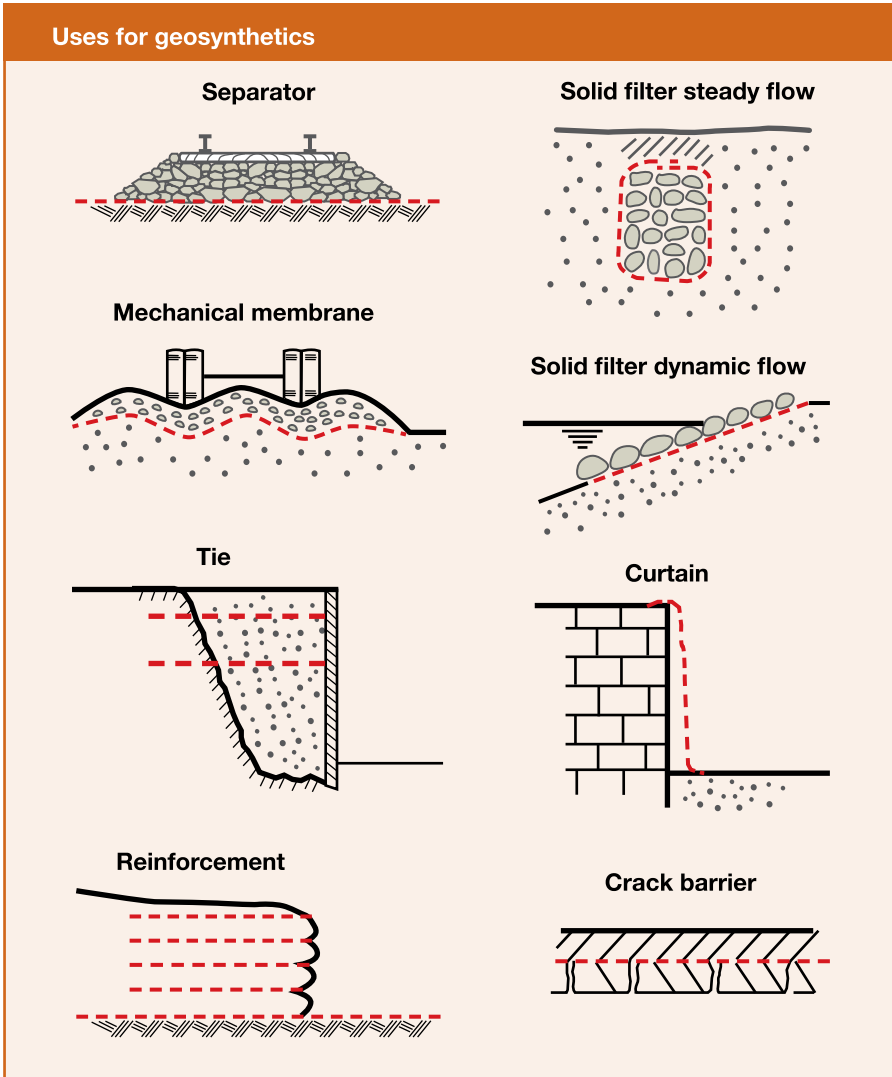

Source: Douglas A. Roadnotes Vol. 2 No.8

the best technique, location and pavement design. Road planners should seek specialist advice prior to using these products.

6.9 Chemical stabilisation of pavement or subgrade

Mechanical stabilisation involves the mixing of two, or more, selected materials to modify particle size distribution or plasticity. Mixing can be carried out on-site, or at a quarry or pit before transportation. An alternative is to use rock crushers or grid rollers on-site to crush existing material. Static or portable vibrating screens can be used to separate material into appropriate sizes and grades before delivery

and mixing. Laboratory tests of both the material to be treated, and the stabilising material, ensures that the desired end result will be achieved. An example of mechanical stabilisation is the blending of a granular material lacking in fines with a sand/clay mix. The finished material will have improved strength, abrasive resistance, imperviousness and compaction.

The purpose of chemical stabilisation is to improve material properties of the subgrade and/or aggregate layers. This can, consequently, reduce the quantity of aggregate required, or allow low quality aggregate sources to be used. Stabilisation can also reduce maintenance costs, and provide a better wearing all-weather road pavement. Unsuitable materials can be modified to overcome their deficiencies using stabilisation techniques and products. Their addition produces a layer within the road with increased strength and rigidity.

The properties that are usually altered by stabilisation include:

- Increased strength (bearing capacity)
- Increased stiffness (reduced flexibility) of soil
- Volume stability, with changes in moisture content
- Reduced soil plasticity
- Increased durability of soil particles
- Decreased permeability.

Most binder materials work by effectively dehydrating the subgrade or aggregate material. This reduces the shrink and swell effect caused by water entering or leaving the material.

Materials stabilised by modification do



not always increase in strength. Cement stabilisation will increase strength and stiffness, allowing, in some cases, a reduction in pavement thickness. However, pavements which are stabilised by cementing action cannot be easily maintained by grading.

Soils and aggregates have a wide range of properties. Consequently, the reaction of a specific material with any particular stabiliser cannot be determined by simple observations, or by defining the soil type. Laboratory analysis is required before using chemical stabilisers, since an incorrect binder material or application rate will not produce the desired outcome. Insufficient quantity of chemical stabiliser can have negligible benefit, while too much chemical stabiliser is expensive and, in some cases, may worsen the properties of the treated soil or aggregate. Consultation with industry specialists should be carried out prior to using these products. The following table provides a guide.

6.9.1 Chemical stabilisation methods

Common types of chemical stabilisation materials include burnt lime Ca(O) and hydrated lime Ca(OH)₂, bitumen and cement.

Lime stabilisation

Lime can be applied to either the subgrade, sub-base or base course layers. The term 'lime' is commonly used to describe a number of products, including burnt lime (quick lime), and hydrated lime (slaked lime). Burnt lime and hydrated lime are the only types of lime which can be used for stabilising soils or aggregates for road pavement construction. Agricultural lime is insufficiently reactive, and will provide no benefits if used for roading applications.

Lime stabilisation requires the minerals present in most, but not all, clays for a reaction to occur. Consequently, lime treatment is ineffective on non-clay soils, and on many coarse aggregates. Organic soils, or soils containing significant percentages of organic material, do not react to lime. Subgrade stabilisation with lime is not recommended where heaving occurs due to freeze-thaw action.

Liming works to improve a soil in three ways:

- The lime reacts with clay minerals and water in an exothermic (heat producing) reaction. This reaction can be exploited to rapidly dry wet subgrade soils that would

Application of stabilisation (after NAASRA 1986)

Type of stabilisation	Process	Effects	Applicable soil types
Hydrated or burnt lime	Chemical alteration of clay minerals Cementitious inter-particle bonds developed	Improves handling properties of cohesive material. Reduced plasticity Low additive contents: • Decreases susceptibility to moisture changes • Improves strength High additive contents: • Increases modulus and tensile strength	Suitable for cohesive soils Requires clay components in soil that will react with lime Organic material will retard or prevent effective reactions Sulphates can cause swelling
Cement	Cementitious inter-particle bonds are developed	Low additive contents: • Decreases susceptibility to changes • Increases strength High additive contents: • Increases stiffness and tensile strength significantly	Not limited – some deleterious components (organic, sulphate etc) can retard or prevent effective cement reactions Suitable for granular soils but inefficient in mainly one size material
Bitumen	Agglomeration of fine particles	Waterproof – also improves inter-particle cohesive strength	Applicable to granular low cohesion, low plasticity materials

6. Pavement design, subgrade preparation, pavement construction – continued



be otherwise unworkable

- The lime reacts with clay minerals to produce cementing bonds. The cementing action increases inter-particle bonding, and can increase soil strength and reduce shrinkage and swelling actions
- The lime modifies the structure of clay particles to make the soil more friable and porous. This produces a soil that is easier to work with and has improved drainage.

Lime stabilisation improves the durability and smoothness of unsealed roads, and can also help reduce dust problems. For forest roads, a stabilisation depth of 150 mm may be appropriate. Additional information on lime stabilisation is available in *TR2 Lime Stabilisation for NZ Roads*, (Dunlop, 2001), Transit NZ (now the NZ Transport Agency).

For each pavement material type, there is an optimum quantity of lime content beyond which the addition of further quantities will provide little, or no, additional benefit. The correct amount of lime to be used (percent by mass), depends on the amount and type of clay mineral predominating in the material. Small quantities of lime (1 to 3%) may reduce the plasticity index, and be sufficient to stabilise some materials, such as clayey gravel, which have good grading but moderately high plasticity. Lime reacts with most plastic materials; however, testing is necessary to determine the reactivity of the material to lime. It has been found that some poorly graded clayey sand and gravels, when treated with small percentages of lime, can become friable, and even completely non-cohesive, leading to failures.

The procedure for lime-stabilised construction consists of spreading lime onto the pavement at the required rate, mixing and adding water to improve compaction; compact the material to seal the surface; leave to completely cure before either allowing traffic to pass over the material or the placement of subsequent pavement layers.

Left: A series of photos showing lime spread on the road, being ripped into the surface, and then a water truck wetting the road to bring the aggregate to optimum moisture content prior to compaction



Cement stabilisation

Cementation is the formation of cementitious hydrates, which increases the cohesion between soil particles. The mechanical properties of cement-stabilised materials improve both with cement content (up to a point), and with time. The effect of cement on granular material is to 'glue' the particles together to form a stronger mass. The cement effectively reduces the material's susceptibility to moisture, thereby reducing shrinkage and swelling. A typical quantity for the treatment of gravel pavement is 1 to 3% by weight. Additional cement can be detrimental leading to cracking of the surface layer which allows water to enter the pavement.

Cement stabilisation procedures are not commonly used for unsealed road pavement designs, as the bonds formed between particles are weak and unable to resist traffic action. Cement does have an effect on clay soil, but in most cases the improvement is not as great as for lime. Using cement stabilisation for the running/wearing course restricts the maintenance practices because reshaping etc breaks the cemented bonds. Cement stabilisation is, however, suited to sub-base stabilisation, or to upgrade poor quality rock, gravel or sand. Technical and construction details are contained in NZTA 2018: *Best Practice Guidelines for Pavement Stabilisation for New Zealand roads*.

Cement blends with lime, slag or bitumen are commonly used to make the process more workable (that is, less susceptible to delay in compaction, less likely to crack over time), and to reduce the cost of using large quantities of cement. Fly ash mixtures can reduce the optimum moisture content for compaction. Lime and cement mixes can be used to stabilise clay-based, or high clay content gravels.

Unlike lime stabilisation, cement cannot be reworked following initial mixing and there is only a limited time before setting of the cement takes place. Mixing of the cement and aggregate should be completed before water is applied. After the addition of moisture, adequate compaction must take place to ensure that the material is compacted and shaped before the cement sets.

Bitumen stabilisation

Bitumen stabilisation is essentially limited to stabilisation of the wearing/running courses of unsealed pavements. The bitumen binder improves stability and strength through cohesion of non-plastic materials, waterproofs the pavement and provides dust suppression. Bitumen stabilisation is best suited to granular materials such as gravels, sandy loam, sand-clays and crushed rock. Construction practices are similar to other stabilisation products, except that compaction is generally delayed allowing the mix to aerate, and excess water to evaporate.

Bitumen stabilisation involves the use of a grader for scarifying and mixing the aggregate layer. A water tanker, with or without pressure spray, is used to apply the emulsion and then the materials are mixed, laid out, shaped and compacted. Depths of from 0 to 150 mm can be treated. Applications of thin films of bitumen produce a stronger material, and thicker films create a weaker, less permeable material. Applying emulsion to an existing pavement is a simple and cost-effective operation; however, it will need to be repeated at intervals of approximately six months.

There are various other products on the market which claim to be effective in reducing dust and stabilising pavements. These include:

- Enzymes: These are natural, biological products. They are becoming increasingly common for use as the basis of a variety of stabilisation and dust suppressant products. The mechanism by which enzymes stabilise a material is a very complex molecular process. Essentially, when the enzymes of a soil stabiliser are mixed with water and applied to the soil, they act by breaking down the clay lattice (that is, breaking down the clods), or by combining clay particles with organic molecules. Enzyme stabilisers are especially designed to stabilise clay-based materials
- Chlorides: Calcium chloride is a salt which acts to bind the material and form a hard

6. Pavement design, subgrade preparation, pavement construction – continued



Purpose built stabilising equipment

surface. Good mixing of the chemical with the material provides for a good effect, and two separate light applications at different times provides a better service than one single application. Sodium chloride has a similar action to calcium chloride. The other option is magnesium chloride, which is not often used in New Zealand.

6.9.2 Equipment used in chemical stabilisation

A variety of machinery and equipment can be used to apply chemical stabilisation products. Various purpose-built machines have been designed to mix the material and add the stabiliser at the same time, generally

giving uniformity of mixing. However, in most forestry situations, the addition and mixing of stabilisation is usually completed using graders, rotary hoes, water tankers and spreaders.

The choice of machinery used for a project is determined by a number of factors, including:

- Source of material to be stabilised – in-situ or imported
- Size of the project
- Type of material to be stabilised
- Availability of machinery
- Availability of trained personnel
- Type of stabiliser to be used.



Chapter 7

Erosion, sediment and slash control structures



7. Erosion, sediment and slash control structures

This chapter describes a tool box of erosion and sediment control measures, including vegetative ones. It also provides detailed information on debris traps, a structure designed to trap larger slash after harvesting.

Investing in adequate erosion and sediment controls at the time of construction makes good business sense. They increase the life of a road or landing, and associated fill slopes, by reducing repairs and maintenance costs. Without good water control structures, the road formation and pavement can rapidly deteriorate, leading to significant safety, environmental and economic consequences. A key factor is identifying ways to decrease both the amount and speed of stormwater to reduce erosion and loss of sediment.

Plan the location of erosion and sediment control structures as part of the overall road or landing engineering design. Likewise, plan the location and design of debris traps as part of the harvest planning process. For all jobs, as part of the overall construction specification (prescription), provide the contractor with details of the structural design requirements and location. For more complex work, spend time on-site with the earthworks' contractor.

The release of sediment into a watercourse has been identified as being a significant factor in the degradation of river and coastal habitat. The NES-PF regulations have specific requirements for sediment and stormwater control measures and debris traps. These are located throughout the regulations, so make sure these are understood. The control of erosion, along with minimising the release of sediment into waterways, is a critical component of forest engineering. Activities which do not meet the permitted activity regulations will need consents. It is suggested that the location, design and construction of the more significant structures, such as major fill areas, sediment retention ponds and debris traps, are documented and photographed.

Another important aspect is to check that the newly constructed structures are working correctly during rainfall, and as designed. If not, enlarge them, add more, or find other solutions to make them effective.

Road maintenance is discussed in Chapter 9. This chapter also includes detailed information

on the maintenance of erosion, sediment and slash control structures. See the FOA *Forest Practice Guides* and the *NZ Forest Road Engineering Manual Operators Guide* for further information on this topic.

7.1 Ditches

Ditches are normally constructed parallel to the road or landing, to channel and direct stormwater from cut banks or berms to an appropriate discharge point. Berms are constructed on the fill side of roads to control runoff. These will be discussed in sections 7.2 and 7.3.

Ditches are often incorrectly called water tables or water table drains. The water table is a physical limit of where the water level lies, so this could be below or above the bottom of the ditch.

Ditches are usually designed with a flat bottom to minimize the potential for scouring and erosion from water flow. Alternatively, a v-shaped ditch may be used if the area has low rainfall and stable soil that will not scour. Examples of design specifications are shown on page 125. In some instances, a straight line from the crown of the road to the bottom of the ditch can be adopted. The advantage of this design is that it is quick and easy to maintain with a grader.

The longitudinal slope of the ditch is very important. A slope which is too shallow will not let water drain quickly, causing flooding and silting of the ditch bed. A slope that is too steep will allow fast water flow, resulting in scouring and erosion of the ditch. As a rule of thumb, a minimum slope of 0.5% (1:200) is recommended to avoid silting. The maximum slope of a ditch will be dictated by the road gradient.

Ditches serve three important drainage functions. They:

- Intercept and drain ground water flow

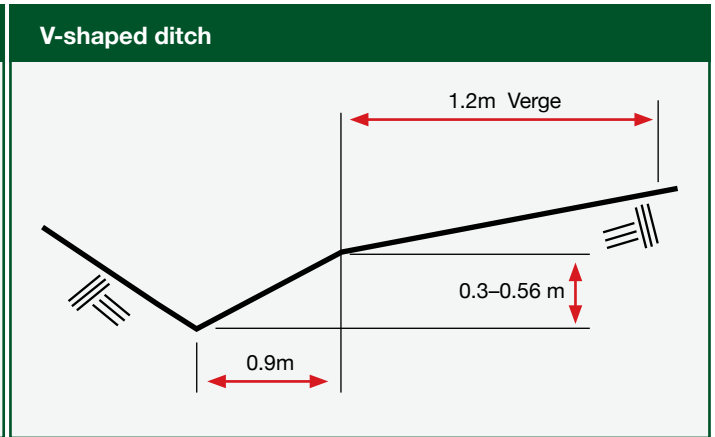
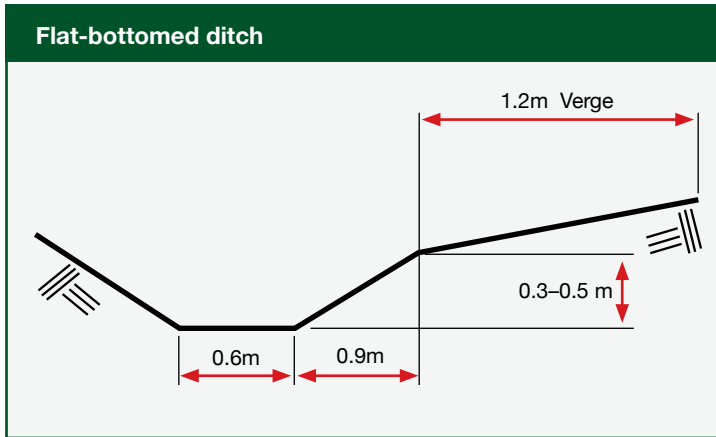

through the cut slope, and surface flow over the cut slope

- Intercept and drain ground water infiltrating from the water table into the subgrade by capillary action
- Capture road surface drainage to prevent water infiltration into the road or landing surface. This keeps the road subgrade drier, making a stronger road. This function requires the road surface to have an appropriate camber (typically 4-6%) to be effective.

On major secondary and arterial roads, or in regions with high rainfall, the ditch depth should be maintained at least one metre below the subgrade surface, so that effective subgrade drainage and ground water interception is achieved.

Consider using rock armouring of ditches where there could be significant environmental risk from sediment or infrastructure failure.



Rock armouring

Armouring is lining the ditch bed with aggregate, preferably fractured to avoid rolling. This slows water flow and limits erosion, as the rock protects the ditch by reducing the energy of the water. Consider use when the culvert or cut-out spacing distance is restricted by terrain, for steeper gradient ditches where heavy rain could concentrate water flow and create erosion, or where ditches are in unconsolidated soils such as volcanic ash. Sediment traps and check dams can also assist in reducing water speed and its erosive power. Alternatively, road aggregate can also be used by applying it to the full width of the road formation including the ditch. Make sure that it is compacted, if possible. If standard road aggregate is not suitable, use a different aggregate after the subgrade is applied to the road surface. Ensure the aggregate is both large enough

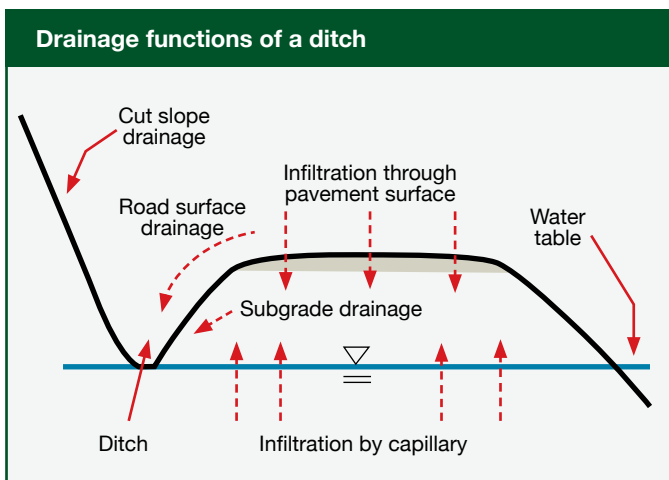

7. Erosion, sediment and slash control structures – continued



Left: Rock armour using subgrade aggregate. Right: Rock armouring is effective, however, in this instance, the rock was not deep enough in parts to stop scouring

and placed deep enough to take stormwater flow. This avoids aggregate being displaced or washed into culverts, and blocking or partially blocking them.

Consider using check dams where ditches are prone to erosion, primarily due to water speed with a large volume flow. Check dams are very small temporary or semi-permanent dams constructed across a ditch and other water channels. They may be used in tandem with rock armour. The lowest point of the ditch should be below subgrade level, about 500 mm below the crown of the road. Check dams can be constructed from larger aggregate or sand bags filled with aggregate.

Ensure water goes over the middle of the dam and not around the edges, otherwise this will lead to scour. Do not make check dams higher or wider than the ditch itself. The diagram on page 127 provides rock dam specifications.

Another option is to use a polymer to make a ditch more resilient to erosion. Polymers can be applied to lock the soil particles together to prevent drainage water from eroding the ditch surface. Be mindful that polymers do not give permanent erosion control. Visit the following websites: www.rst.co.nz/soil-stabilisers.html or www.vitalindustries.com.au.



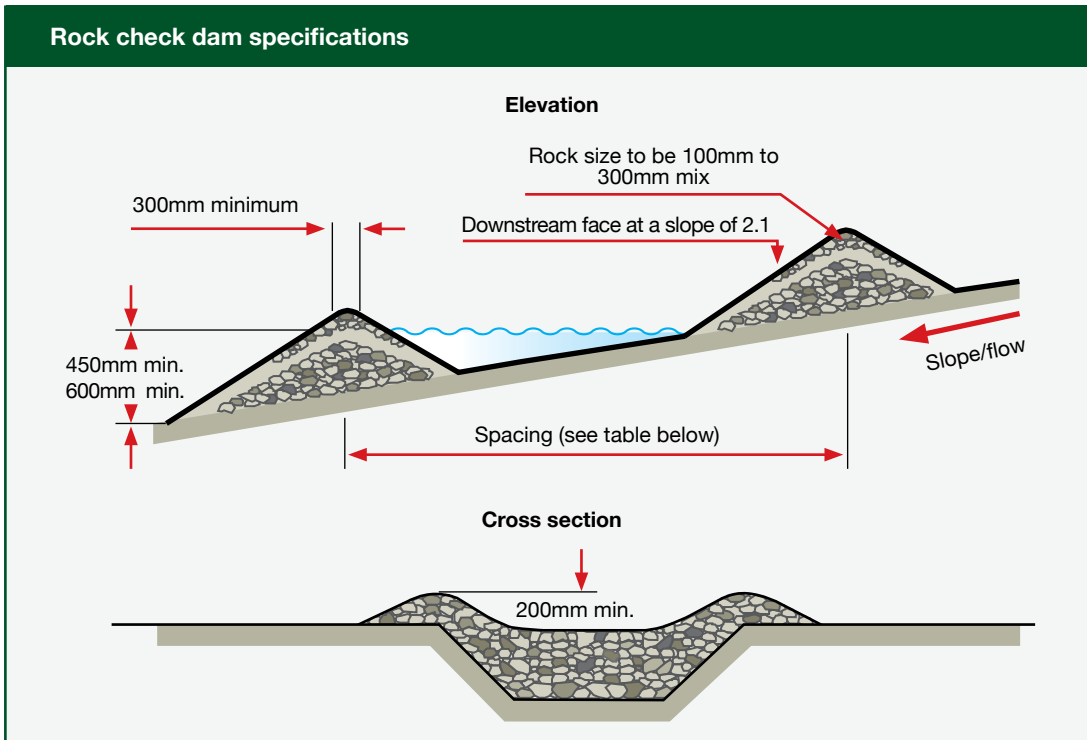

Slope	Spacing (m) between dams (450mm centre height)	Spacing (m) between dams (600mm centre height)
2% or less	24	30
2% to 4%	12	15
4% to 7%	8	11
7% to 10%	5	6
over 10%	Use stabilised channel	Use stabilised channel



Left: A functioning ditch after heavy rain. Right: A heavily scoured ditch that has bypassed the culverts. Rock armouring and appropriate culvert spacing would have limited the impact

7. Erosion, sediment and slash control structures – continued



Left: Cut-out leading to a flume. Right: Cut-outs with water bars and now-filled sediment traps on a decommissioned road

7.2 Cut-outs

A cut-out is a small ditch that takes water from a road surface or road ditch, and allows the water to discharge to an area of stable ground. They are simple to construct, effective, and easily maintained. Cut-outs may direct water to additional water control measures such as culverts or flumes, or through sediment control structures such as slash bunds, sediment traps and sediment retention ponds. Cut-outs are also used to decommission roads or tracks when they are no longer required, to control stormwater run-off. As far as practical, locate

cut-outs where the outlet would not cause additional erosion.

Construct enough cut-outs to reduce the volume and velocity of runoff, so as to reduce the erosive power of the water. Refer to the road drainage culvert spacing guidelines; cut-out discharge points are identical to culvert requirements.

After installation, check that the number of cut-outs is sufficient to control stormwater runoff. If not, add additional ones or other water controls.

7.3 Berms

A berm is a low embankment, typically found on the outside edge of a road or landing, and often used in steeper, erosion-prone terrain. They are constructed to channel stormwater away from vulnerable areas to cut-outs, and act as an additional erosion and sediment control measure. Berms can reduce erosion from surface scouring or fill failures. Berms can be used to channel water from erosion-prone fill slopes and old slip faces onto hard and stable ground via additional water control structures, like cut-outs or flumes, or to direct water to sediment control structures, like through slash, sediment traps and ponds or silt fences.

Build berms at the time of road or landing construction. Use an excavator to construct and compact the berm fill. Where berms are



Managing temporary harvesting tracks is not discussed in this Manual, but cut-outs play an important role in track rehabilitation



to be constructed, the roadway width needs to be slightly wider to contain the berm footprint. Ensure the fill slope has not been over steepened by the berm. Fills that are too steep are more prone to failure if the natural angle of repose of the soil has been exceeded. Do not use berms to store excess fill. Build berms only as wide as required, as adding a berm will increase the load on the outside road edge and

may create additional instability in highly erodible soils (exceed shear strength). If necessary, it is recommended to grass or hydroseed berms to protect them in sensitive areas. Where practicable, avoid spraying vegetation on the berm when doing a pre-plant, desiccation spraying. Consider armouring berms where cut-out spacing is restricted by the terrain, or cannot easily be addressed with flumes or drainage socks.



Left: Lack of a berm to control stormwater discharge over vulnerable fill has caused fill failure and sediment loss. Right: Overlarge berms create additional risk. An enlarged berm has been constructed to store excess material from cut banks. This has spilled down the fill slope to the water way in the gully. Despite compacting, the fill is now unstable and showing signs of collapse



Left: Well-compacted berms were used to protect a large fill slope by directing water away from the more vulnerable earthworks. Water has been directed to cut-outs and flumes on either side of the fill. Right: This large fill is showing failure, despite having cut-outs and flumes, and will lead to environmental and access issues unless modified. The berms are too small, and the low point of the road is in the middle of a large fill slope, rather than at one end where the water can be more easily directed to original ground

7. Erosion, sediment and slash control structures – continued



Above: An uncompacted berm vulnerable to sediment loss and failure. Right: A well-constructed berm with rock armoured ditch, hydroseeding and a slash bund at the base of the fill to contain sediment. A flumed cut out has been used to convey runoff over the fill. This berm will help protect the road and limit sedimentation



7.4 Drainage culverts

Water needs to be regularly discharged from a ditch to reduce both water velocity and volume. This is critical on light and weak soil like pumice to minimise scour, and is achieved by the regular placement of road drainage (stormwater) culverts or water cut-outs. A drainage culvert drains water from the inside to the outside of the road where there are no opportunities to direct it off from the inside. If properly designed, constructed and maintained correctly, they will last a rotation and often longer. Culverts used to cross rivers are described in Chapter 8: River crossings.

Drainage culverts are often made of corrugated PVC. Do not use untreated wood or pine logs for permanent drainage culverts. It is good practice to construct a sediment trap immediately before a culvert inlet. Road drainage culvert outlets that drain onto stable, non-modified ground require no additional erosion and sediment controls, although using slash to armour the culvert outlet from potential erosion is good practice. Road drainage culverts may have additional sediment control measures down slope of their outlet, including flumes, sediment traps, soak holes or sediment retention ponds.



A typical drainage culvert inlet with a sediment trap before it. The trap is deeper than the pipe inlet, and it can easily be cleaned out by an excavator

The NES-PF's earthworks stormwater regulations require a road drainage culvert to have a minimum internal diameter of 325 mm in green or yellow zones, and orange zones less steep than 25°, and a minimum internal diameter of 375 mm for NES-PF red zones, and orange zones steeper than 25°.



Recommended maximum spacing (m) for road drainage culverts located on roads traversing mid and lower slopes

Grade	Soil or rock erodibility and distance spacing guide (m)			
	High	Moderate	Low	Non-erosive rock
18% (1 in 6)	40	80	120	200
14% (1 in 7)	50	90	140	220
12% (1 in 8)	55	100	160	240
11% (1 in 9)	60	115	180	260
10% (1 in 10)	65	130	210	300
8% (1 in 12)	80	165	250	350

Space and locate road drainage culverts correctly. The table above provides a guide to appropriate culvert spacing. The suggested maximum spacing relates to soil type and road steepness for roads that traverse across the mid and lower slopes. On roads located on ridge tops or flat/rolling topography, maximum spacing may well be greater than those in the table due to the ditches not intercepting water from the terrain above the road. Where topography makes it difficult to achieve the minimum spacings, consider using larger pipes and rock armouring at culvert inlets and outlets. Culvert outlets are best located on solid ground and not on fill. Also consider the likelihood of culvert blockage and the subsequent risk to other drainage structures. Cut bank collapse can choke the culvert entrance. This can be relatively common on new roads in weak soils or friable/crumby rock. To reduce the risk of damage to the road, and potentially on-going environmental issues, it may be prudent to consider a higher culvert density and larger sized culverts.

The table shows that the steeper the road and more erodible the geology the closer the culverts need to be placed. Use local knowledge to help refine spacing for specific locations and soil types. Intensity of rainfall should also be considered. A greater frequency of culverts, deeper ditches and larger culvert sizes may be required to address risks.

Avoid drainage culverts that discharge directly into a river or a water body. Where practicable,

water should flow over land to filter through slash or natural vegetation before entering the water body. Install road drainage culverts a short distance up gradient of a river crossing. This will help reduce sediment into it.

7.4.1 Drainage culvert location and installation

Culverts need to be correctly located and installed. Where possible, locate culverts to avoid fills so that they can discharge water onto stable ground to reduce sedimentation. Locate drainage culverts away from road corners to reduce damage by vehicles.

The following provides guidelines on installing drainage culverts:

1. Culvert pipes should be installed according to the pipe manufacturer's specifications
2. Install road drainage culverts during road construction, and prior to metalling the carriageway
3. Preferably, install culverts with an excavator
4. Locate on hard ground, and avoid fill
5. Set the culvert at a minimum 20° across the road or at the same/similar road grade, unless the road is being drained from two directions
6. Ensure there is enough gradient on the culvert. Use a minimum 3% crossfall to reduce the risk of blockage
7. Ensure the culvert trench base is even and compacted, and running at the correct gradient along its entire length
8. Join pipe sections in the trench
9. Make sure there are no sharp rocks or objects in backfill that could damage the pipe
10. Ensure backfill is compacted in layers. Polyethylene pipe will deform, as its structural integrity relies on the compacted fill
11. Where needed, build a solid bund at the culvert inlet to ensure stormwater is directed into the culvert mouth, and does not bypass the culvert
12. Construct culvert inlets with associated silt traps so they are easy to clean out with an

7. Erosion, sediment and slash control structures – continued



Culvert installation steps: 1. Construct the inlet. 2. Dig the trench at an angle to the road. 3. Bedding the culvert. 4. Compact fill around and over the culvert. 5. The completed culvert with markers

excavator. Make sure the dimensions allow easy bucket access, so that the culvert mouth does not accidentally get damaged when collected sediment is removed

13. Consider building culvert inlet protection to stop slash and debris blocking the culvert
14. Armour culvert inlets and outlets if necessary
15. Bury the culvert to a depth recommended by the manufacturer
16. Where required, flume or sock water away from fill
17. Mark culvert locations. Use a culvert marker or scrape a clear identifier in the cut batter, and GPS their location. Culverts will need to be easily found when the road verges are overgrown.



7.5 Flumes

Flumes help to protect earthworks from erosion by conveying water over vulnerable areas, such as fill and batter slopes, to more stable ground. Most roads in hill country require sections to be flumed. Flumes, like drainage culverts, require fall to reduce silting up. Install flumes at the time of drainage culvert construction.

Flumes come in several types. They are often made of half round sections of flexible corrugated material, such as polyethylene half round sections. Flexible flumes are less prone

to failure, as they bend to follow the terrain and the corrugations decrease the water speed. Corrugated iron should not be used. Consider using flexible, full round flumes for very windy sites, as they can better withstand windy conditions compared to half round flumes. Culvert sock flumes are an enclosed fabric sock. As their name suggests, the sock flume is pulled over the culvert, and clamped on to the culvert outlet. They can be used where standard fluming would not work effectively, for example, if directing water over long and unstable fills.

Flumes can also be used to direct water to



Left: The flume has good fall to reduce silting, is well pegged, and drains into slash to reduce erosion. Ribbed flumes slow water down compared with smooth bored flumes. Right: The fully flexible pipe is a good option for this exposed location



Left: Galvanised iron or tin flumes are not good practice. They increase water speed, and cannot easily follow the terrain. The sheets do not lock together, and can fall apart. Right: Rock armouring cut-outs and culvert exits are an effective way to reduce water speed and scouring

7. Erosion, sediment and slash control structures – continued

additional sediment and stormwater control measures, such as slash and sediment traps. Where the flume discharges to stable ground, still consider slash, rock or half pipe energy dissipation at the outlet to reduce the velocity and energy of the discharge. Where additional sediment control structures are to be used, ensure the flume is located at a suitable site to construct these.

Construct a solid flume entrance that will not be bypassed by storm flow. Inlets to flumes are a common failure point. Ensure the entrance is well compacted and armoured, if necessary. Ensure the flume is anchored and well supported to avoid displacement or separation from the culvert outlet. Make sure that the flume has a minimum slope of 3 %. This will stop the flume from infilling with sediment.

Be careful with culvert sock installation. Secure the sock to the culvert so that water does not undercut or rip off the sock. Ensure the sock has a minimum slope of 5%. This will stop the sock from infilling with sediment. Anchor the sock eyelet and attach it to the ground for its entire length to avoid twisting. Twisting can lead to the sock malfunctioning, and the weight of sediment and water can pull it off the culvert. Consider installing socks upside down, with tie-down points tied up to the holes in steel Y-posts (waratahs), to stop potential rolling in strong wind locations if other installation methods have failed.



Above: Many components in this image are poor practice. The flume entrance is likely to be bypassed, the flume is poorly pegged, and debris from the slope above is already rolling into the lower flume and partially blocking it. This will create infrastructure and environmental risk.

Below: The flume failed because the outlet was not armoured so water undermined and collapsed it



An effective way to reduce sediment is to use an energy dissipater like slash, rock or a short section of flume perpendicular at the exit, in conjunction with a silt fence



Flumes are needed to reduce fill scour or fill failure. This unprotected outlet will become an issue on the first rain then become an on-going problem



Left: Culvert sock securely attached to culvert and anchored. Right: A poorly designed and secured sock; the inlet has been bypassed and the wind has twisted it

7.6 Sediment traps and soak holes

Sediment traps and soak holes are small excavated structures. They capture sediment-laden water, allow sediment to settle, then water to either discharge or drain. They reduce the volume of sediment that can enter sensitive sites, such as waterbodies. They should be located close to roads and landings to enable easy access for maintenance.

To be effective, sediment traps need to be large enough to slow flow, and allow some of the larger sediment particle sizes to settle, before the water is discharged. Soak holes are constructed in porous soils such as sand

and pumice, allowing sediment-laden water to soak into the soil. Although sediment traps and soak holes are constructed similarly, they work differently. Some sites not suitable for either type of sediment control. These include a fill batter, where they increase the risk of bank collapse, or where the site is located within land that carries flood flows of rivers.

Construct sediment traps near culvert inlets and outlets, and immediately after water is directed, near a road, track, or landing as necessary. A recommended effective sediment trap size is 1 m deep x 1.5 m long. A good length to width ratio is 3:1, but this is not always practical at



Good examples of a sediment trap at a culvert mouth (left) and a soak hole

7. Erosion, sediment and slash control structures – continued



Left: Making sufficiently effective sediment traps is challenging in steeper terrain. This one is a potential safety concern as it is encroaching on the roadway. Right: Although this trap has worked, it is too small and not deep enough below the culvert mouth

culvert inlets due to topographical constraints and safety concerns. For example, on steep terrain, adequately sized cut-outs are difficult to construct near culvert mouths as they may encroach into the roadway, creating a health and safety hazard. Multiple small traps of at least the bucket width may be an alternative option. Do not construct sediment traps or soak holes in fill where they increase the risk of bank collapse or within the floodplain of rivers.

Soak holes are constructed similarly to sediment traps, but are constructed in porous soils such as sand and pumice, allowing sediment-laden water to soak into the ground with no discharge.

Excavate the trap to well below the culvert inlet level, to ensure maximum sediment retention capacity for the trap. Install on hard ground

rather than fill or disturbed soil. Use a rock bucket to excavate. Make them large enough so that an excavator bucket can be used during maintenance to remove the retained sediment. Keep the slope of the inlet into the soak hole reasonably flat, to avoid erosion. If the inflow or outflow is through fill, then flume into and/or out of the sediment trap. Consider sediment retention from the outflow. Additional sediment controls like slash or grassing or the use of polymers may assist, if needed.

Soak hole spacing guide

Site slope	Soak hole spacing
Less than 12%	40m
More than 12%	30m down to 10m



Left: A good example of a sediment trap with minimal ground disturbance and provision of an outlet. Right: There are sediment traps at both the inlet and outlet of this culvert. Immediately below the outlet is a waterway



7.7 Silt fences

Silt fences are designed to intercept sheet flow sediment-laden stormwater runoff, and filter out larger, and some of the smaller, sediment particles, but not dissolved clays. Silt fences, and the larger 'super' silt fences, are a short-term solution to reduce sediment movement until the site stabilises, and vegetation re-establishes. Silt fences are usually made from geotechnical fabric, but at times shade cloth can also be used to allow water to pass through it while filtering larger particle sizes. Silt fences can be used in conjunction with other sediment treatment measures, such as sediment traps or ponds.

Silt fences need to be carefully located. Only use silt fences to intercept sheet flow water on low gradient sites, or in confined areas where the contributing area is small, less than 0.5 ha. Plan the location of silt fences to be constructed where they will not be overwhelmed by large flows. Use longer 'super' silt fences for larger areas, where the catchments are greater than 0.5 ha. Do not use them in larger areas, or in concentrated flow paths to capture sediment like rivers, gullies or in ditches. They are not designed to reduce water flow velocity. Fence fabric is only partially porous, so too much flow may cause them to fill too rapidly and either fail or be bypassed.

Silt fences also need to be correctly constructed. Make sure the correct fabric for

the silt fence is selected. Silt fence fabric is a close weave and intended to capture fine sediment. Shade cloth and open weave fabrics will trap larger sediment grain sizes, but not fine sediment. It is also important to install the fence along the contour. If this is not possible, or where there are long sections of silt fence, install short silt fence returns projecting upslope from the silt fence, to minimise concentration of flow. Also, construct silt fence wings at either end to contain sediment where there is a risk of bypass.

The following is an overview of the installation process:

1. Silt fence returns should be a minimum of 2 m in length, and can incorporate a tie-back if required. Continue the silt fence around the return and double back to eliminate joins
2. Use support posts or Y-post steel standards (waratahs) at a maximum 2 m apart, unless tensioned wire (2.5 mm HT along the top of the silt fence) is used between posts, top and bottom. If tensioned, the distance can be widened to 4 m
3. Double the silt fence fabric over and fasten to the wire and posts with wire ties or cloth fastening clips at 150 mm spacing
4. Join lengths of fabric by doubling over fabric ends around a wooden post or batten, or by stapling the fabric ends to a batten and butting the battens together



Two well-constructed applications for sediment fences

7. Erosion, sediment and slash control structures – continued

Silt fence design criteria			
Slope steepness %	Max slope length (m)	Spacing of returns (m)	Max silt fence length (m)
Flatter than 2%	Unlimited	N/A	Unlimited
2–10%	40	60	300
10–20%	30	50	230
20–33%	20	40	150
33–50%	15	30	75
Over 50%	6	20	40

- Recommended maximum slope lengths, spacing of returns and angles for silt fences are given in the table above
- Excavate a trench at least 100 mm wide and 200 mm deep along the proposed line of the silt fence

- Install the support posts on the downslope edge of the trench. These should be tanalised timber of a minimum of 50 mm square, or waratahs at least 1.5 m in length. Drive in until solid, at least 400 mm deep
- Tie silt fence fabric on the upslope side of the support posts to the full depth of the trench
- Silt fence height should not exceed 300–400 mm above ground level
- Backfill the trench with compacted fill
- Use angled waratahs at the end of the silt fence to tension wires
- Reinforce and tension the top of the silt fence with a 2.5 mm support wire (refer back to point 2)
- Where ends of silt fence fabric come



Well-functioning fences. They have captured most of the larger sediment and have not failed, despite containing a significant weight of material. Right: Maintenance is required for the shade cloth fence



Left: Sediment fences are not designed for watercourses. They fill rapidly, divert flow, or fail. Right: This fence is inadequate. The lower edge has not been buried properly, so has blown out. The fence is not wide enough, and there are no wings so stormwater flow would have bypassed it. Also, it is too close to the waterway immediately behind it



This large silt fence looks well constructed, however the fabric has been installed on the wrong side. It should be on the uphill, so the wire will help support the fabric and stop it from blowing out. The lower edge of the fabric has not been buried because you can see where the sediment has flowed underneath it

together, ensure they are overlapped, folded and stapled to prevent sediment bypass

14. Construct extra tie-backs, on the upward side, where water may pond behind the silt fence.

7.8 Sediment retention ponds

There is a fundamental difference between sediment retention ponds and smaller structures like sediment traps. The philosophy behind the location and design of the structures, discussed in this chapter so far, has been to reduce sedimentation by dispersing water as close to source as possible. Sediment retention ponds rely more on a 'concentrate and treat' approach. As their name suggests, these are ponds designed to

retain sediment, so they can be large structures that can hold high volumes of sediment laden water. They allow coarse to moderately fine particles to settle out of water before it is discharged. Sediment retention ponds are not effective where colloidal clay particles are in suspension, or where there is concentrated flow. Decanting earth ponds are a retention pond variant that uses an inverted syphon pipe in the pond centre as an outlet. These are common in large earthwork construction, such as new residential housing estates, where water flow paths are part of the earthwork design.



A small sediment pond. It has a low gradient cut-out to the inlet, and is constructed on the hard. It has a broad and flat, cloth-reinforced outlet to slow water



Left: A poorly constructed sediment pond. It is located on fill, is not level, and both the inlet and outlet are scoured. The lowest part of the pond is almost at outlet level. This could completely fail if water overtopped it. Right: A well-constructed pond draining a landing. It is constructed in the hard. It may become challenging to protect the structure during the harvesting phase as it is incorporated within the landing. Both structures require maintenance, so should be accessible

7. Erosion, sediment and slash control structures – continued

Sediment retention ponds in forestry are typically only used in situations over very large earthworks to minimise the discharge of sediment laden stormwater into highly sensitive receiving environments. They are used when other methods are inadequate for the site.

It is best to seek specialist advice to determine sizing and design flow capacity. Unless they are designed and constructed to specifications, there are a potential safety hazards to personnel and machinery working in the vicinity, and off-site risks if the structure fails. The consequences of failure can be significant.

Design the structure to fit the terrain. Do not try to use a retention pond if the site is not large enough to size it properly. Never construct them in fill material. Large volumes of water create high static pressure that could cause fill to saturate and fail. Also ensure that they are not installed within the active flood plain of rivers.

When constructing sediment retention ponds, excavate in original ground. If the inflow or outflow must pass through fill, then flume the water into or out of the structure. The outlet is generally constructed at the opposite end to the inlet to maximise settling time. The length to width ratio should be at least 3:1 to extend the flow path from the inlet to the outlet, and provide time for sediment to settle out from the stormwater. Keep the slope of the inlet/outlet reasonably flat and broad to avoid

erosion, or if not possible, form a rock armoured spillway or flume if necessary. Ensure the outflow is on stable ground. Slash or long grass can assist with sediment retention.

7.9 Debris traps

The aim of debris traps is to catch larger slash that would otherwise be transported out of a catchment in flood flow conditions. They are often used in high risk harvest and post-harvest river catchments to limit slash movement downstream from the forest, especially where it could cause problems for downstream property owners or infrastructure like roads, bridges, culverts, farm fencing, and recreational areas. Debris traps are generally constructed in the channel of a river. Debris traps need to be carefully located, designed and constructed. Refer to *Debris Flow Control Structures for Forest Engineering*, D.F. VanDine, British Columbia Ministry of Forests 1996 and www.geobruug.com/en/Debris-flow-barrier-UX-7949,7859.html.

The NES-PF has many permitted activity conditions for installing, using, maintaining and removing debris traps. A resource consent is required if any of the NES-PF permitted activity conditions cannot be met, so check the regulations prior to construction. Resource consent is needed to install debris traps in catchments larger than 20 ha, unless the debris



Left: These small traps were constructed to limit debris crossing from the forest into the adjoining property. Right: Logs can be an easy and effective option in this situation



Left: An effective slash trap. Right: Effective slash trap installed upstream of road and bridge. An accessible site allows removal of slash and maintenance of the debris trap

trap is located on a terrace on one side of the river as opposed to in the active 'bankfull' bed of the river. The terrace(s) should allow the overflow of any excess material that may build up against the trap, to reduce pressure and risk of the structure failing.

Careful location of debris traps is critical to reduce impact on the river, effectively trap larger debris, and for ease of access for construction and removal of trapped material. It is preferable to locate the debris trap in a location with a readily available area to dispose of any trapped material. For example, a flat area above flood flow level. This will reduce the cost of maintaining the debris trap. If cleaning requires debris to be removed off-site, then the structure will need to have truck access. Do not construct where the natural alignment of the river could lead to the channel alignment or gradient being altered by debris building up behind the structure and creating a weir. Also, do not locate a debris trap where it will cause erosion of the banks and bed of a river, or if the debris trap could adversely affect downstream properties and infrastructure.

Good design is essential. This will help ensure that the debris trap is effective, and has met regulatory requirements. Design the trap for a minimum six year engineered life, to ensure that the structure will be effective for the length of the post-harvest 'window of vulnerability', when slash movement is more likely. There must be free movement of water through the structure and fish passage must be provided. Consider

using specialist engineering advice when planning and designing larger structures, or where the consequences of failure could be significant.

There are several design features that should be incorporated to reduce the risk of the structure from failing, and to minimise the combined energy of water and weight of debris on the trap during peak flows:

1. Trap the larger debris only, rather than trapping or damming all debris
2. Construct in a low gradient reach of the river, if possible
3. Position at right angles to the river. If there is a natural bench, then slightly angle it downstream to aid slash being deposited onto it. There is evidence that a tapered, constructed debris arrestor is effective for directing debris to banks, but they require longer length and likely more irons/beams in the river
4. Consider whether a series of debris traps (two or more) would be a better solution than one slash trap.

Debris traps are often made from rammed railway irons or steel beams threaded with wire rope, and anchored solidly at each end. The following provides guidance for their installation:

1. Use the largest railway iron gauge available or appropriately specified steel universal beams, such as I-beams or RSJs
2. Build the trap at least 0.5-1.0 m higher than the river bed
3. Drive irons/beams into the river bed to a depth of at least 1.5 m

7. Erosion, sediment and slash control structures – continued



Left: Radiata stumps are not preferred anchors, as many will have lose their tensile strength within the design life of the structure. Right: There was too much energy in the river and the structure failed. The storm flow moved large boulders, as can be seen of the far river bank. Consider putting traps in side creeks or where the river's energy lowers



Left: A tapered debris retention fence during heavy rain. Note the debris trapped in the structure. Right: Post clean-up

4. Space railway irons/beams 1.5-2 m apart and no closer than 1.5 m. If they are closer too much material could be trapped
5. The irons should be no more than 2 m above the river bed (if higher, a resource consent is required)
6. Ensure there are smooth-sided holes cut in the upper sections of the irons/beams (for threading the wire)
7. Support railway iron/beam uprights with a wire rope of minimum 22 mm diameter
8. Anchor the wire rope to deadmen or large trees on either river bank to secure the slash trap. Insert a knot in the rope and supporting clamps on either streambank to secure the slash trap. The anchors are an integral component of the structure. Do not anchor onto stumps as these lose root strength rapidly. If you anchor to standing trees gauge their windthrow vulnerability
9. Maximise tension in the rope
10. Secure clamps to the wire rope immediately on either side of the railway irons/beams to create rigidity. Clamps stop the irons/beams from being forced out of alignment when under pressure
11. Short logs or railway irons/beams can be driven into the terraces adjacent to the slash trap, to catch more material in high flows
12. If it is likely that trapped debris could divert river flow during a flood event, the bank should be armoured to prevent scouring
13. Consider excavating, if necessary, a larger catch basin if space allows.



Chapter 8

River Crossings



8. River crossings

This chapter discusses options for river crossings. It covers the different types of crossings and their advantages and disadvantages, and gives an overview of installation methods. It does not cover drainage culverts that are used to direct water from the ditches under a road. These are described in Chapter 6: Erosion, sediment and slash control.

The term river, to be consistent with the definition in the NES-PF, includes all continually and intermittently flowing bodies of fresh water; it includes what foresters and forest engineers commonly refer to as streams and other waterways. The NES-PF definition is different from a dictionary definition, where a river specifically refers to a larger stream.

Crossing rivers is an integral part of road construction. Roads regularly need to cross rivers to access forest operational areas. River crossings must be correctly designed and constructed to meet safety, environmental, operational and cost requirements. Crossing waterways should be kept to a minimum. They are expensive, and increase the risk of adverse environmental effects.

Crossings must comply with relevant Acts and regulations, including the Building Act 2004, the NES-PF, and the Freshwater Fisheries Regulations 1983 (FFR83). The NES-PF has specific conditions for various types of river crossings, and clear permitted activity rules. The general rules are for notice, effects on other structures and users, fish passage, erosion and sediment, location, flow calculations, contaminant discharge and organic matter. This Manual has tried to strike a balance, so that the specifics of the rules are not repeated verbatim, but are instead paraphrased and incorporated into the design and construction requirements for river crossings.

The common types of river crossings used on forest roads in New Zealand are:

1. Fords, either unsurfaced fords or concrete pad fords
2. Temporary crossings, including corduroy log bridges
3. Single culverts – including round, arch (half pipe), box, or oval culverts
4. Battery culvert crossings
5. Drift decks

6. Single-span bridges, either permanent structures or temporary portable structures.

Ensure that higher risk, or more significant, river crossings are located and designed by an experienced person. If in doubt, seek expert advice; the consequences of failure can be significant. Not only are river crossings expensive to rebuild, there can also be significant operational and environmental implications. Bridge construction requires structural design input, and will usually involve a chartered professional engineer (CPEng) for certification, so that building consents can be obtained.

8.1 Fish passage

Where fish are present, the proper choice of a structure, and its correct installation, will reduce the impact on habitat and ensure fish passage. Over half of New Zealand's 35 (or so) indigenous fish species migrate up rivers when they are small. Juvenile fish may lack the ability to swim upstream through a long steep culvert. While many are good climbers, they cannot enter projecting culverts. Not all culverts require fish passage. Some locations do not have fish, or the likely presence of them. This could be due to large natural barriers downstream, the distance from the coast, or their altitude.

The Department of Conservation (DOC) and regional councils have specific responsibilities to manage fish passage in New Zealand waterways under the Freshwater Fisheries Regulations 1983 (FFR83) and Resource Management Act 1991 (RMA91), respectively. The FFR83 regulations came into force on 1 January 1984, so they generally apply to all structures built after 1 January 1984. However, regulation 42(2), which is the requirement for culverts and fords to be maintained to prevent the development of fish passage barriers, applies to all culverts or fords built before and after 1984.

The NES-PF have specific permitted activity conditions for fish passage at river crossings, and the discharges, disturbances, and diversions that can impact on fish spawning. The Ministry of Primary Industry (MPI) has



produced the fish spawning indicator, which is a tool to help councils and foresters plan forestry operations. See <https://www.mpi.govt.nz/growing-and-harvesting/forestry/national-environmental-standards-for-plantation-forestry/fish-spawning-indicator/>. It shows where and when fish that are sensitive to bed disturbance are spawning. For permitted activity status, river crossings must provide for the upstream and downstream passage of fish, except where a statutory fisheries manager advises that fish passage would have an adverse effect on the fish population upstream. For example, access for trout to predate on isolated galaxiids. The river crossings must provide for passage by maintaining river bed material in any structure that would be in place of the river bed.

The following are principles of good fish passage design, while also taking into account other design factors including cost and hydraulic flow requirements:

- Maintain continuity of in-river habitat within the culvert. The NES-PF requires that the invert be embedded by 20% of the culvert height
- Minimise alterations to river alignment
- Minimise alterations to river gradient
- Maintain water velocities and depths within a range equivalent to adjacent river reaches
- Minimise constraints on bankfull channel capacity resulting from the structure
- Avoid vertical drops
- Provide an uninterrupted pathway along the bed of the structure.

Bridges, temporary bridges and large open bottom culverts provide excellent unhindered passage. Culverts aligned with the river, of an appropriate size, with similar gradient and with culvert inverts set well below the river bed, are also fit for purpose. Fords are the least preferred crossing type, as they do not prevent vehicles or animals from entering the waterway. Natural fords provide uninterrupted fish passage; however, concrete pad fords need to be carefully constructed so they do not restrict fish passage, especially in periods of low river flow.

Culverts can be retrofitted to improve fish passage. The *NZ Fish Passage* reference, listed



A perched projected culvert eliminates fish passage

Poor culvert design restricts fish passage

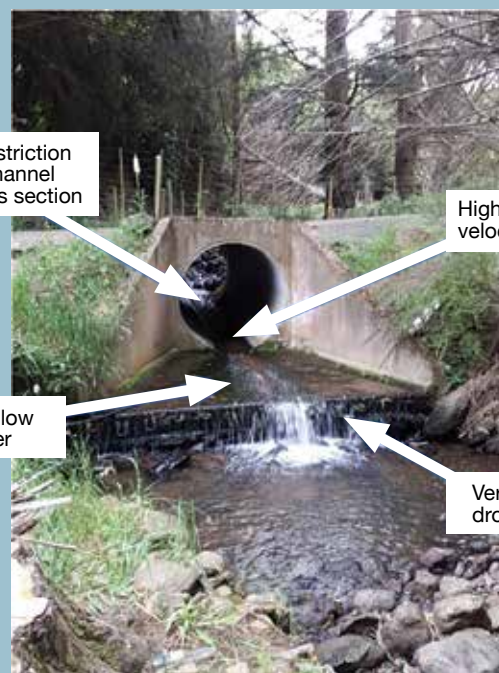

Credit: Sam Drummond and Dr Paul Franklin, NIWA

8. River crossings – continued

at the end of this section, provides several options. Mussel spat ropes are the most cost-effective solution for forestry, but they need maintenance since they can be swept away in storm flows. Mussel spat ropes can be used on culverts where the diameter is less than 1.2 m. When installing them it is recommended to:

- Use a minimum of two rope lines for a 0.5 m diameter culvert. For larger culverts, more ropes may be necessary
- Install ropes so that they are tight and flush with the base of the culvert through the entire length of the culvert, and not loose at one end or out of the water
- Set ropes apart to provide ‘swimming lanes’ between the ropes
- Tie knots (half hitches) along the sections of rope in the culvert barrel to break up the flow, and potentially create additional rest areas for fish
- Use non-loop rope types to reduce the likelihood of debris snagging on the ropes
- Anchor ropes to shackles attached to waratah sections upstream of the culvert
- Drive anchors below river bed level or on the river banks
- Seek specialist assistance and view online resources.



Mussel spat ropes are the most cost-effective solution for fish passage. (Credit: Bruno David, Waikato Regional Council)

A good reference document is the *New Zealand Fish Passage Guidelines for Structures up to 4 Metres* (DOC 2018). It provides useful and comprehensive information on new structures, and on how to retrofit non-compliant crossings. However, the designs are more suitable to highways rather than forestry applications. See www.niwa.co.nz/freshwater-and-estuaries/research-projects/new-zealand-fish-passage-guidelines.

8.2 Selecting the location and crossing type

Take time to decide on the river crossing site, and the type of crossing. River crossings are expensive and should be designed as long-lasting structures, unless they are designed for temporary use and removal. Potential crossing locations and their conditions need to be assessed and understood. A good river survey is essential, and substantial or sensitive crossings will need more planning. Surveys should include measuring channel profiles and cross sections to better understand flow conditions, and assessing the river bed and bank condition along with any indications of normal flow and past flood levels. Knowing the shape of the river at the proposed structure location improves the data accuracy for hydraulic modelling, which helps to optimise design solutions, and assists in developing construction plans and details.

The road approaches to the river crossing are important to get right in terms of grade and alignment, not only for the intended traffic but also to minimise the potential for sediment entering the river at the crossing.

For bridges and culverts, the optimum crossing sites are likely to be where the waterway is narrow and straight with stable banks, the crossing length is short, and the roadway can be arranged to cross perpendicular to the river. For battery culverts, drift decks and ford crossings, the preferred sites will be where the waterway is wide and shallow, with low banks that allow river crossing approaches to enter the river with gentle gradients, while also being perpendicular to the river. Note that ford crossings are only a permitted activity where



the number of axle movements per day is less than 20.

The following factors influence what type of waterway crossing may be most appropriate for a site. Consider how these factors will affect the design, construction and ongoing use of the crossing:

- Catchment size, shape, and topography
- Rainfall timing, frequency, and intensity
- Rainfall runoff characteristics, as influenced by soil type, geology and vegetative cover
- Normal water flow level and design flood level
- Stability of the river bed and banks
- Risk of woody debris transport during storm events
- Channel geometry. For example, wide and flat versus narrow and incised
- Size of forest area served by the road and crossing
- Forest access requirements. For example, long-term versus temporary access; all-weather versus fair-weather access
- Traffic characteristics. For example, logging traffic versus light vehicles only
- Water quality requirements
- Ecological importance of the particular river. For example, aquatic habitat and fish passage
- Availability of construction materials and machines
- Permitted Activity conditions for River Crossings in the NES-PF (Regulations 37-46).

A profile of the river at the proposed crossing location

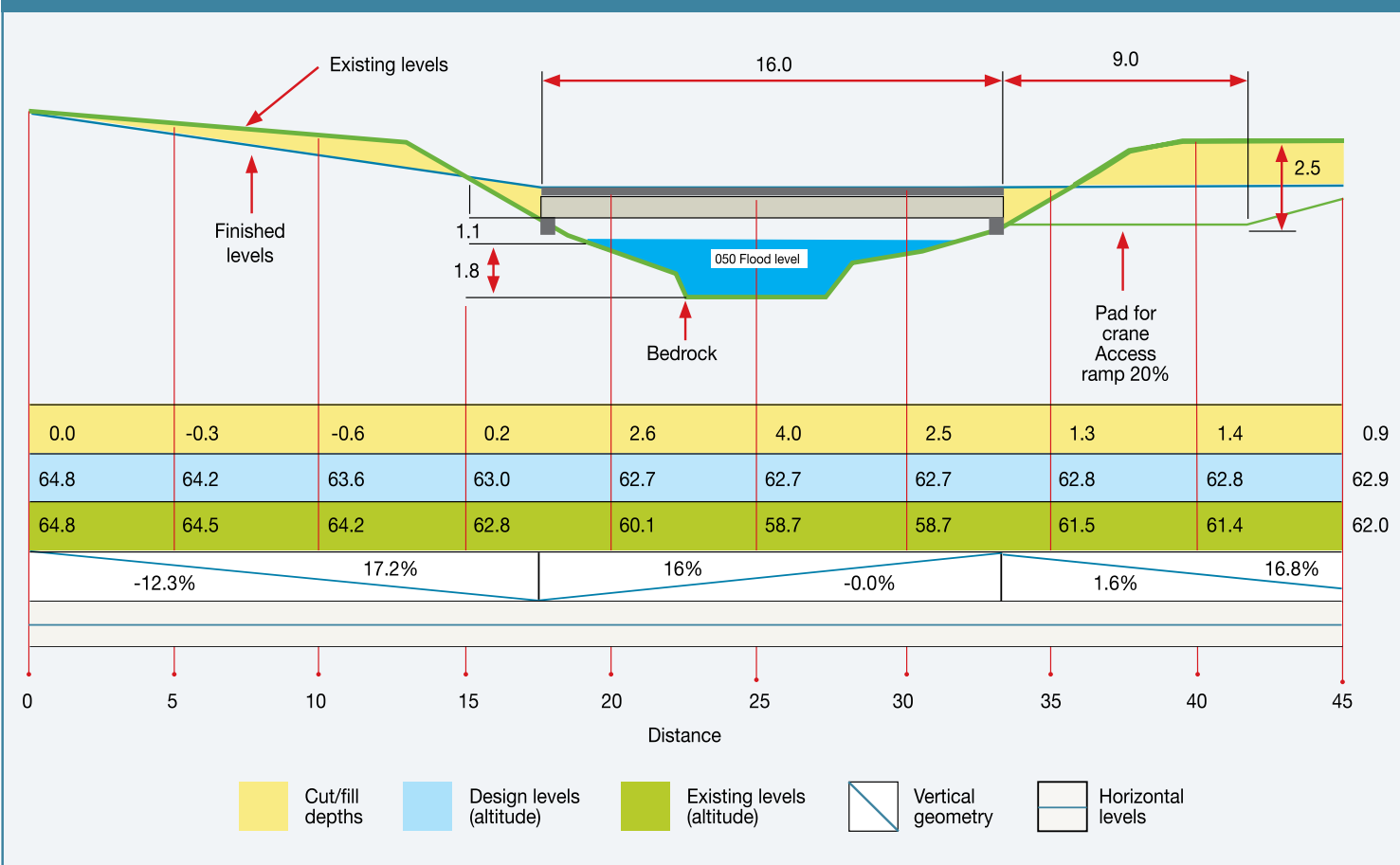

8. River crossings – continued

8.3 Fords

Fords can be graded natural river beds or consist of a concrete pad in the river bed to assist with vehicle traction and to reduce sedimentation from vehicle passes. Fords can be used to cross small, low-flow rivers but are more generally used to cross broad, shallow or intermittent rivers, where the river bed is stable. For example, shingle or rock substrate. This topography makes alternative types of river crossings difficult or impractical to construct. Ideally, fords are used where traffic volume is light, or where traffic use is only for a short duration. For example, in a small woodlot harvest with a low productivity contractor. Fords are also often used as a secondary crossing point, where bridges cannot provide access for heavy and large forestry machinery, like haulers or construction machinery, due to weight or width restrictions. The use of fords can create significantly more sedimentation than other forms of river crossings, because sediment is generated from the approaches through water wash from the moving vehicle, storm water not being effectively diverted and treated before entering the river, and from mud off tyres.

The advantages of fords are that they can be used where other crossings would not work. Also, their design is not sensitive to flow. Fords can accommodate very large flows and associated debris that cannot be not reasonably passed through culverts or short bridges. Also, they are typically the lowest construction cost of all river crossings.

Fords have both traffic management and environmental disadvantages to other crossings. There will be periodic safety and traffic delays during high flow conditions, where traffic cannot cross the river or where traffic tries to cross when it should not. Also, heavily used fords generate considerable instream sediment. Concrete fords are the least favoured of fish passage structures because they become a fish barrier, especially in low flow. If possible, consider converting a ford to a drift deck, battery culvert or bridge crossing when traffic volumes increase at harvest. This will create a better structure and help reduce sedimentation.

The NES-PF has specific rules around the fording of rivers. It is essential that the regulations are clearly understood at the



Left: Log truck using a natural ford crossing. Note that sediment comes from mud on the tyres, river bed disturbance, and displaced water that washes over the approaches and back into the river. Right: A concrete pad ford reduces sediment but can be a barrier to fish passage



planning stage. The NES-PF Regulation 97 means that both a discharge permit and a resource consent for disturbance of the bed of a river will be needed, where:

- There will be more than 20 axle crossings per day
- If certain fish species are present, and
- Where there is a conspicuous change in colour or clarity beyond a 100 m mixing zone for more than 30 minutes after use.

Note that the NES-PF Regulation 97 requires a resource consent for any new concrete pad in the bed of a river, where that river is listed in a regional plan or water conservation order as a habitat for threatened indigenous fish, or a fish spawning area.

8.3.1 Ford design

One of the first considerations is to decide whether to use the natural river bed or to construct a concrete pad crossing. The factors to consider include river bed substrate, volume of traffic movement, acceptable risk of road closure, downstream impact of sediment generation and impact on fish. Another important consideration is identifying a good crossing point. It is essential that the best site is chosen that meets constraints related to road location, grade and alignment.

Characteristics of a good crossing site include:

- Locations on a straight section of river. Approaches that are perpendicular to the river help reduce scour of the approaches and stream bed
- Locations that do not alter the natural course and gradient of the river, or create erosion of the banks and bed
- Concrete pad fords that are located on stable and low gradient sites
- River beds with shallow water depth, and substrate that is hard and stable. For example, natural crossings on rock, as opposed to muddy substrate, help to reduce sedimentation and improve vehicle access
- Crossing approaches that have suitable

gradient and transitions, so that vehicles are not grounded, especially low loader transporters

- Road approaches that are not steep, as these are ongoing sources of sediment
- Concrete pad fords that are designed to withstand flood flows. Rivers are prone to bed shifting. If water gets under the pad it can be undermined and displaced.

Like other river crossings, it may be prudent to consult with a forest engineer, hydrologist or other specialist to help with design and construction if the skills in-house are limited.

8.3.2 Ford construction

The key to good construction is doing the construction at the right time, keeping the approach gradients as low as possible, and making sure that the sediment generated from the crossing is reduced by diverting water from the approaches to sediment control structures. The keys to controlling erosion and sediment delivery from roads to rivers include providing adequate surface cover, that is gravel, and reducing runoff volume and velocity with frequently spaced water control structures. The following are good practice guidelines for ford construction:

- Construct in suitable weather, and with low base water flows
- Check for any fish spawning timing constraints under the NES-PF
- Limit earthwork disturbance to the immediate construction site
- Minimise the need for machinery to operate in flowing water
- Limit sedimentation entering the ford from the approaches
- Divert road surface water off the approaches
- Ensure fish passage is not impeded
- Construct stormwater and sediment control measures as close as practicable to the crossing, and ideally within 10 m. For example, use berms, cut-outs, ditches and culverts, flumes and sediment traps. Build these above the annual flood flow level
- Provide surface cover on the approaches. Use

8. River crossings – continued

clean gravel where the existing road surface would create a sedimentation problem

- Check regularly during and on completion of construction. If the work does not meet the design plan and standards, then initiate corrective actions.

An additional factor for natural river bed crossings is to use clean rock fill where the carriageway requires strengthening of the river bed. It is important to use graded rock that is large enough to resist displacement by the flow of water. Fill the gaps or voids between this material with clean, small rocks or gravel to provide a better driving surface.

Additional factors for concrete pad crossings include ensuring that the river is diverted to assist in constructing the foundation, to reduce the risk of contaminants entering the water, and to minimise discharge of sediment. Also construct the concrete pad so it extends well beyond the extent of the river channel when at medium flow. This will help reduce entry and exit erosion of the gravel at the transition zone from the concrete to gravel, and further reduce sedimentation from the wet area generated by vehicle wheels displacing water when exiting the crossing. An important construction requirement is to armour the leading edges of concrete pad fords with aprons. This will reduce the river undermining the structure.

8.4 Temporary river crossings

River crossings serve two principle purposes. The first is to access a harvest site, where the crossing and possibly the road, will be decommissioned after harvest. The second is in harvesting operations, where log extraction requires the need to temporarily cross a river. Temporary road prefabricated single span concrete bridges will be discussed in the single span bridge section of this chapter (9.10.3 Single span bridges). These structures can be designed for both temporary and permanent placement.

Temporary river crossings can be in place for up to two months, whereas temporary single span bridges can be in place for up to two years. So be careful to meet the regulatory requirements around 'temporary'. Also, the NES-

PF does not consider a ford to be a temporary crossing; it is a crossing irrespective of how long it is in use. Constructing, using, maintaining or removing a temporary river crossing or temporary single-span bridge is a permitted activity if regulations within the NES-PF are met, otherwise a resource consent will be required. Many of the construction requirements have been incorporated into this section, however, it is essential to refer to the regulations to understand the relevant obligations.

Temporary river crossings, like permanent ones, must be carefully planned, constructed and maintained otherwise they could cause a significant safety or environmental risk. Plan for all temporary crossings at the infrastructure and harvest planning phase. Key factors to consider in determining the type and size of the structure is the catchment size, the river's banks, width and substrate, and downstream infrastructure. Ensure the crossing locations are clearly marked out for the operator.

Temporary road river crossings need to meet design standards for transport-related loadings. Therefore, the structure and its components need to be engineered. These can include a removable culvert and log structure sitting in the bed of the flow path, or removable concrete or steel bridge spans and abutments. The design varies with the river and approach of the extraction track. No crossings are needed for machines crossing dry gullies, however this is obviously weather-dependent. It may be prudent to have a temporary crossing plan ready for when these gullies become wet.

Flood plain shingle river beds can be a dilemma for all crossings. The best option may be for these to be temporarily crossed without a structure, because built-up access approaches and the volume of logs or metal required to cover the culvert(s) may compound potential risk during floods.

The following image is an example of a low-cost, portable river crossing alternative to a ford, drift deck or battery culvert that is suited to a smaller, short-term operation. It is an option to consider for a river not subject to frequent flooding or gradients steeper than about 3%,



A portable temporary bridge specifically designed to accommodate truck traffic. This will be a cost-effective crossing when used in the right location

with high bedload movement. Otherwise, it will have high maintenance due to blocking up with gravel and structure displacement, leading to it needing to be pulled out and reset. It was made of untreated rough sawn Douglas-fir and larch, braced by steel cross ties, and cost about \$3500 to build.

The following is recommended practice when constructing temporary river crossings:

All crossings

1. Minimise the disturbance of the natural shape of the river. Excavations of banks and bed must not exceed 200m², otherwise a resource consent will be required
2. Minimise soil entering the river during construction. Pull back material to a position where it will not enter the waterway
3. Reduce potential sediment entering the water body from the crossing approaches. This is an important consideration for their location, design and construction. Where practicable:
 - a. Flatten the steepness of the crossing approaches
 - b. Divert water from the approaches. Methods include outsloping, installing cut-outs and sediment traps
4. Consider factors like the catchment size, the waterway's banks, width and substrate, and local climate
5. Use the right equipment. An excavator is essential for most crossing construction
6. For crossing designs that restrict the flow

of water, install a culvert of at least 375 mm at the base of the crossing to allow water movement. Do not use only logs at crossings. Water does not easily drain though, which leads to upstream ponding.

Harvest extraction temporary crossings

1. Plan for temporary harvest crossings. Avoid letting the contractor determine the number and location of them
2. Consider the harvest crew equipment in the design of the structure
3. Log bridges are effective at spanning small waterways, but need to be carefully constructed. It is recommended to limit bridges to less than 1 m above the ground, otherwise the structure needs to be designed by an engineer and meet legal requirements. Bridges must be constructed to:
 - a. Carry the logging equipment across it
 - b. Pass the flood flow from a 5% AEP event under the bridge soffit
 - c. Enable the passage of bed material
4. Locate as few crossings as needed to safely and productively harvest
5. Design approaches so that logs do not sweep off the crossing into the waterway when extracted. For example, logs can be driven vertically at corners and crossing entrances to keep trees aligned to the crossing
6. Ensure the contractor knows the crossing construction requirements. Provide instructions or other supporting paperwork (job prescription) and on-site guidance to the contractor if needed. Sign-off the job with them
7. Ensure the crossing locations are clearly marked out for the operator
8. In addition to the recommended practice for all crossings, consider the following to reduce potential sediment entering the waterway from the approach tracks:
 - a. Use corduroy or slash to cover the approaches within 20 m of the river, unless approaches are of low erosion material like rock or river gravel

8. River crossings – continued



A temporary steel crossing

Top left: A corduroy crossing with a pipe larger than 300 mm on the river bed. Top right: A rehabilitated temporary crossing. Note that the logs have been removed from the channel, turnouts have been installed for water control, and slash has been used to stabilise the approaches

Centre: Approach tracks are a significant potential source of sediment. Centre left: This track will be an ongoing source of sediment. Earth slurry will flow directly into the river in wet weather. Centre right: This log crossing has good approaches that have corduroy or slash, low grades, and are outsloped to shed water

- b. Wherever practicable, maintain the track grade over the crossing to reduce potential sediment entering the water body from the approach tracks
9. Remove all crossing material from the banks and river bed within a week of constructing the crossing and finishing the job.



8.5 Single culvert river crossings

Single culverts are still the most common structure used to cross small to medium-sized rivers on forestry roads. They are best suited where there is a low level of river bed load (gravel) movement that could infill the culvert, and a low risk of debris entering the river. Compared with most other waterway crossing structures, culverts are easy to install and relatively low cost. Careful planning and installation are required to prevent failure and ensure fish passage. Resource consents will be required where the culvert does not meet the permitted activity conditions within the NES-PF. With regard to location, a resource consent is needed when the river crossing is within 500 m of a dwelling that is within 15 m of a river bed greater than 3 m wide, or downstream of a dwelling with a ground floor level that is less than 1 m above the highest part of the river crossing.

8.5.1 Types of culverts – pipe, box and arch

Many types of pipes are suitable for waterway crossings, but in terms of design, the pipe and box culverts are generally used. However, arch type culverts are becoming more common, especially for larger rivers, as they retain the natural river bed. Culvert pipes can be smooth or corrugated, and can be made from a wide range of materials – plastic, concrete, galvanised steel or aluminium. The service life, ease of transport and handling during construction, the relative cost between types, the importance of fish passage, and soil and ground conditions will determine which type of pipe is best for the site. Plastic pipes are now most common as they are lighter, but more importantly, can flex a little to accommodate differential settlement of the road over time. Other pipe sections, for example second hand steel drill casings, are relatively low cost and make functional culverts, especially for temporary waterway crossings.

Corrugated pipes are commonly used for small to medium applications. They are made of polyethylene, galvanised steel or aluminium. Polyethylene is typically used for the smaller culverts, and steel, or aluminium in some

instances, is often used for the medium-sized structures. Transportation and handling costs are lower than for concrete, due to their lightweight design. Polyethylene is an extruded product, and steel and aluminium come from roll-formed pipe sections; they all come in long lengths (6 m), and require less pipe joining. They can easily be assembled on the job; for example, polyethylene can be cut to length on-site with a saw. Small pipes may need only one or two people to lay them into position. Some pipes require the use of the manufacturers' proprietary joining systems.

Corrugated pipe culverts have a lower water discharge capacity than the same sized, smooth-walled pipes. The disadvantages of corrugated pipes are that they are reliant on the soil envelope to provide strength, are easily damaged during installation, and are less durable than concrete because they are subject to abrasion. Galvanised steel also corrodes. They are also easily damaged by floating debris, so they need to be installed where there is a low risk of debris damaging the structure, or where debris traps are installed upstream. With pipe culverts, it is difficult to establish and maintain fish passage, especially if they are not constructed below the bed level of the river. Polyethylene pipes are resistant to corrosion, but are more sensitive to improper installation due to their greater susceptibility to collapse under a non-uniform load. Corrugated aluminium pipes are used in situations where the soil or water is likely to corrode galvanised steel pipes. Due to their durable characteristics, they have a longer life potential in harsh environments.

Corrugated multi-plate pipes are larger corrugated, galvanised steel culverts constructed using a 'multi-plate' system. The pipes are assembled on-site from a series of curved plates bolted together to form a large circular or arched pipe culvert barrel or pipe. These enable the installation of large pipe culverts in locations where transport of a large concrete or roll-formed steel pipe to the site is impractical.

Reinforced concrete pipes have very good hydraulic characteristics, and are excellent for

8. River crossings – continued



Example of a corrugated pipe culvert across a small waterway

situations where a high load-bearing capacity is required. They are less dependent on the soil envelope, less susceptible to construction damage and can be re-used. Concrete culverts will last for long periods without corroding or losing their structural strength, and are resistant to bedload abrasion. They do have several major disadvantages. Due to their hydraulics, it is difficult to establish and maintain fish passage, which may necessitate the fitting of fish passage baffles within the base of the culvert. Also, supply and installation are relatively expensive. They are heavy, so machinery is required to load, transport, unload and place them in the river. For example, a 2.4 m (diameter) concrete pipe segment with a length of 2.5 m weighs nearly 6 tonnes. As such, it is important to understand the lifting capacity of available machinery. For example, a 20-tonne machine can lift around 5 tonnes, while a 30-tonne machine can lift around 8 tonnes. The rubber ring joining system makes laying more difficult. Also, the pipes are in shorter lengths, necessitating more pipe joints and, if the fill moves, socket connections can separate.

Arch culverts are generally open-bottomed structures, sometimes referred to as half-pipes, or they can have a flattened steel base. Arch culverts can either be a steel pipe arch or steel multi-plate. They can span up to approximately 8 m and can cope with relatively high flow rates.



Examples of smooth-bore concrete pipe culverts with and without wingwalls. The photo below demonstrates the potential issue of fish passage, due to high water velocity



The advantages of arch culverts over pipe culverts are that they maintain a wide natural river bed, improve hydraulic capacity during low flows, and cause less heading up of the river during flood flows. These factors will also improve fish passage. Arch culverts require foundations that can resist the arch compression loads. They may be an attractive alternative to



An arch culvert that maintains the natural channel substrate

a bridge where foundation soil bearing capacity is good on each side of the river. They need to be designed by a suitably experienced person, preferably an engineer.

Box culverts typically consist of rectangular concrete box segments tied together with longitudinal steel bars to form the required culvert length. They are available in a range of sizes up to several metres wide and high. Other configurations include U-shaped troughs with lids, and an inverted U system founded on a concrete base. Using box culverts has several advantages. They can cope with large flows



Example of a large concrete box culvert

where headroom is limited, and for an equivalent waterway area, they can accommodate significantly larger flows than corrugated pipe alternatives. They have a large and robust mass, so they are able to withstand overtopping, and are resistant to heavy bedload movement. Another advantage is the minimal excavation and backfilling required. Off-the-shelf precast units are loading certified and as such, box culverts can be designed to carry heavy wheel loadings with little or no fill material placed over the culvert to distribute the load. Also, baffles can be easily installed to aid fish passage. An obvious disadvantage is that precast concrete units are heavy, and may require a crane to put them in place. This makes supply and installation relatively expensive. For example, a 4 x 2 m concrete box culvert can weigh nearly 11 tonnes. Also, like other culverts, they can create a permanent control point in river beds, and require ongoing bed and channel maintenance.

8.5.2 Culvert design

The necessary design criteria include a determination of the flow rate (volume per unit time, in m^3/s) and depth of water associated with a 1-in-20-year storm event for a given river location. The culvert should be sized to pass the design storm flow without heading up. Refer to the section for calculating storm flow. Other important criteria consider environmental and social effects of the structure. For example, fish passage or downstream river users. This requires using a mix of engineering formulae and judgement to determine the required culvert size. The flow capacity of the selected culvert is a function of its cross-sectional area, surface roughness and length. Use existing structures, where present, as a tool to gauge the culvert pipe size against that derived from the flow calculations. Also consider that smaller pipe diameters may be more prone to plugging, and require more frequent maintenance to keep them open.

Culverts must be designed to cope with the expected flood flows from the catchment. The NES-PF's permitted activity rules are specific around culverts. For example, the NES-PF permitted activity rules require that a single-pipe culvert must pass a 20-year storm event

8. River crossings – continued

of no more than 5.5 m³/s without heading up. Also, if the invert gradient is greater than 6% on river channels greater than 3 m wide, a resource consent will be required. The NES-PF also specifies a minimum diameter for a single pipe culvert to be 450 mm.

There may be some circumstances where design to a lesser flood event is appropriate. Examples include temporary harvesting access roads where the culvert will be removed within two months, culverts in locations where an alternative flood overflow path can be provided, and/or culverts on access roads where it is acceptable that they are inaccessible to vehicles on occasions during periods of high rainfall. Where culverts are designed to carry a lesser flood, they should be installed so that they will not contribute to any adverse environmental or downstream effects on landowners if the culvert overtops.

Given the costs and risks involved for large culverts, or culverts higher than 3.5 m (measured up from the bed of the river at the inlet – including the pipe and fill), it is recommended that flood design calculations are peer reviewed. It is also recommended that in higher risk situations it may be necessary to consult with a forest engineer, hydrologist or other specialist to help with both design and construction. For additional information on how to calculate culvert size, refer to section 8.9 Prediction of flood flows and sizing culverts, and Schedule 2 of the NES-PF for flood design flow calculators. The regional council can request a copy of your

flow calculations, so keep a record on file.

When designing a culvert, consider the following to determine the type and size of the culvert:

- The catchment size and its geology, soil type and topography
- The expected flood flows, and the probability of these occurring during the period the culvert is in place
- The traffic usage and the importance of the road; for example, a short-term spur road versus an arterial route
- The potential to provide overflow paths, to avoid damage should the culvert capacity be exceeded in a major storm event
- The risk of adverse upstream and downstream effects; for example, to the environment, infrastructure and dwellings
- Upstream and downstream passage of fish, if present or likely to be present
- The amount and type of woody debris that might reach the crossing in a storm event.

To determine the specific location of the culvert:

- Locate the crossing on a straight section of river to reduce scour of the approaches, if possible
- Try to avoid locations that alter the natural course and gradient of the river, or create erosion of the banks and bed of the river.

Also, ensure that the culvert is the right length. If the culvert is too short, the batter slopes are

A culvert pipe of adequate length

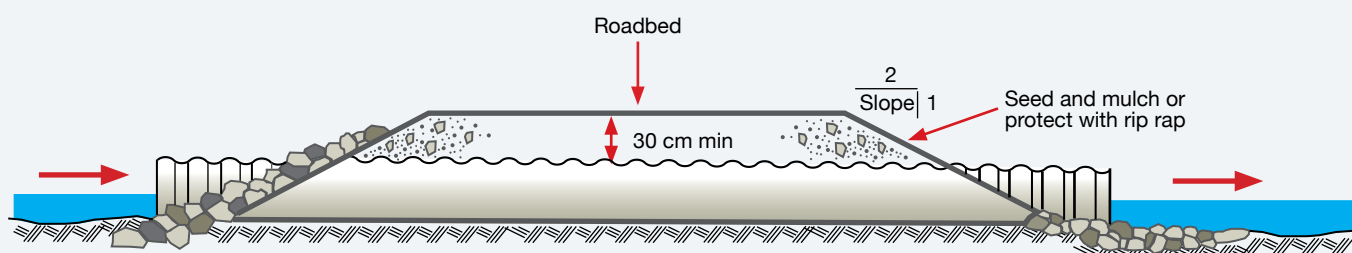

Source: Keller and Sherar (2003)



Left: This culvert needed a retro-treated log retaining wall to prop up the vertical fill slopes. Right: Again, the culvert was too short. And the 'fix' has failed. Tyres and untreated radiata logs are not acceptable for culvert armouring, because radiata rots rapidly, and tyres can readily move downstream if the structure loses integrity

over-steepened. This can lead to the fill slope slumping, and the discharge of sediment into the river. Consider designing armoured spillways where culverts may be at risk of overtopping.

8.5.3 Culvert installation

Culverts must be installed correctly. Most culvert manufacturers provide specifications for the installation of their products. These may vary between types of culvert pipe and between manufacturers. Also, it is critical to meet the requirements of the NES-PF for culvert installation. Therefore, it is very important to refer to both the NES-PF regulations and the supplier's specifications. The following are general points for culvert installation. Some points are specific to pipe culverts; however, most are applicable to any type of culvert. Also, some of these points are linked to permitted activity requirements within the NES-PF.

- Construct in suitable weather, and with low river flow
- Check for any fish spawning timing constraints under the NES-PF
- Limit earthwork disturbance to the immediate work site, which will include an area upstream and downstream of the crossing site
- Minimise the need for machinery to operate in flowing water
- Divert the river around the culvert trench

temporarily to make sure the culvert foundation is properly prepared. This also reduces the risk of contaminants entering the water, and minimises discharge of sediment. Culvert pipes should never be installed directly into a flowing river bed, because proper installation cannot occur

- Take care not to damage the culvert during installation
- Construct the culvert trench or bed at the correct depth and grade, so that when constructed, both the inlet and outlet are 20% below river bed level. This will allow for fish passage
- Bed the culvert in, so that it lies flat and is supported on the firm base of the trench. Ensure the pipe will bed into the surface underneath it, preventing water from flowing underneath it. A uniformly sloping bed is required
- Make the trench wide enough for proper compaction at the sides during backfilling
- Backfill, using clean fill for example, with no organic matter. Compact around the pipe, to eliminate water bypassing the culvert, and scouring it out. Compaction should be carried out in layers, using vibrating plate or oscillating plate compactors. This allows a significant proportion of the applied vertical load to be transferred to

8. River crossings – continued



Left: Construction showing a temporarily diverted river. Right: Culvert installed on hard material with the fill being compacted. Note that the culvert appears to be perched in the photo, but it is not. Always consider the fish passage

the surrounding side fill material

- Wet or curing concrete must not be in contact with flowing water. Cement is a contaminant, and is toxic to invertebrates and fish. When pouring concrete, the water channel must be temporarily diverted
- Armour the inlet headwall and outlet, to help protect the structure from erosion, where necessary. Use rip rap, reno mattresses, durable logs, gabions, wing walls or energy dissipating structures. Always armour the culvert mouth and exit to above the full pipe diameter. Do not use tyres, untreated wood or logs to construct the headwalls of the structure
- Divert road surface water away from the river crossing and culvert fill, within 10 m where practicable
- Use storm water and sediment control measures to limit sediment entry into the river; for example, berms, cut-outs, ditches, flumes and sediment traps
- Check regularly during, and on completion, of construction. If the work does not meet the design plan and standards, then initiate corrective actions.

If an earth channel and bunding is used to divert the river, consider using a geosynthetic cloth to reduce the release of sediment into the river. Also, before redirecting the river through the installed culvert pipe, pump out any sediment-laden water that may have accumulated in the pipe or

at its ends. Discharge well clear of the river into a soakage hole, or where it can filter through vegetation or soil before re-entering the river.

When constructing the bedding, do not use large rocks that would apply uneven point loads on the pipe or box. This could cause excessive stress in the pipe wall, leading to failure. In situations where high settlement of the underlying ground is expected, it is advisable to crown the bedding slightly upward near the centre of the culvert, so that after settlement, the pipe will be near the desired grade, rather than having a sag in it.

Flexible culverts, which are manufactured from polyethylene, steel or aluminium, are susceptible to deformation and possible collapse if the backfill around the pipe is not uniformly compacted around the full diameter of the pipe. Rigid culverts, such as concrete pipes or concrete box culverts, have their walls reinforced to carry the load. Rigid pipes still require adequate compaction of backfill to ensure there is no leakage along the outside of the pipe, and to avoid future settlement of the pipe backfill. Large concrete pipes will deform under load if the backfill is not well compacted. The diagram below gives recommendations for the size of the trench required for culvert installation.

Ensure the fill batter slopes are not too steep. It is important that the culvert pipes are long enough to ensure the batter slopes are not steeper than normal earthworks fill slopes,

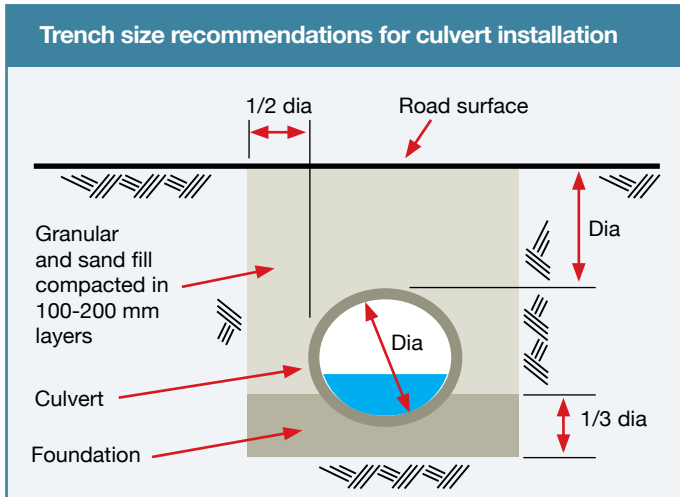

Left: Ensure provision of adequate cover of compacted fill over the pipe. Right: Poor compaction during culvert installation has led to failure as water is now bypassing the structure



The large culvert with bagged cement and sandbag headwall has been designed to resist scour in debris laden flood flows

except where specific culvert headwalls or retaining walls are used. Debris barriers should be considered. There are many useful designs in guides such as the US Federal Highway Administration hydraulic engineering guide, *Debris Control Structures: Evaluation and Countermeasures*, www.fhwa.dot.gov/engineering/hydraulics/pubs/04016/he09.pdf.

8.5.4 Minimising culvert failures

Culverts are susceptible to blockage and overtopping, especially in recently harvested catchments where there may be a high proportion of debris entering rivers during floods. This is the predominant cause of culvert failure. For this reason, special care in the design and installation of culverts is necessary to minimise the potential adverse environmental effects of

a culvert blockage or blowout. Good design, location and culvert construction methods, along with good harvest practices, will reduce the risk of culvert failure. Avoid locating culverts in bends in the river channel immediately upstream of the culvert entry. Also avoid double barreled culverts, where two smaller culverts are used instead of one larger one.

The damage caused by a blocked culvert can be significantly reduced by providing a low overflow point offset from the culvert fill location. In the event of blockage, water will flow over more stable ground rather than erode out the culvert fill, discharging large amounts of sediment into the river. For example, on higher risk sites where exceptional flood flows could carry debris that may block a culvert. Consider designing

8. River crossings – continued



Left: A well-functioning spillway that protected the road when logging debris, mobilised by a 1-in-50-year storm, blocked the culvert mouth. Right: An expensive, inconvenient problem with potential environmental and downstream impacts. This pipe culvert failed when it was blocked by woody debris

culverts to allow flood flows to pass over the culvert via a spillway. Design the structure to have a low point at one end of the crossing on undisturbed ground adjacent to the structure. Building an armoured spillway is a controlled activity in the NES-PF; controlled means that a resource consent is required to divert the river or otherwise modify the bed of a river.

8.6 Battery culvert river crossings

Battery culverts consist of several pipe or box culverts installed beside each other in a river bed. The road is formed over the pipes to create a low-profile crossing. The normal river flow passes through the culverts, but during flood events water flows over the top of the crossing. This allows the dry passage of vehicles in normal conditions, but may result in the road occasionally being closed to vehicle access for short periods during large storm events. Battery culverts need careful planning and installation to prevent failure.

Consider using a battery culvert when a single culvert is impractical to meet full design flood flow, or a bridge is too expensive or has other design challenges. It is recommended to use a battery culvert instead of a ford when there will be more than 20 axle crossings per day, and the ford would generate fine sediment with vehicle passes. A good alternative to consider is a drift

deck. These are discussed in the section 8.7. They may be cheaper, and have the option of being able to be used as a temporary river crossing.

Battery culverts are not recommended in high-gradient, high-energy river reaches because these are susceptible to high rates of bed load movement. This can result in gravel and boulders lodging in and blocking culvert pipes, and increased maintenance. During flood flows, the structure can be outflanked, which can scour out the approaches. It is a



This battery culvert provides for fish passage



regulatory requirement to ensure fish passage is maintained, except where approved by a relevant fisheries manager.

Always refer to the NES-PF at the planning stage. It has specific rules for battery culverts, and they should be clearly understood. Resource consents will be required where the battery culvert crossing does not meet the permitted conditions within the NES-PF. For example, for a battery culvert to be a permitted activity, the contributing catchment area must be less than 500 ha.

8.6.1 Battery culvert design

How the battery culvert is designed is critical to ensuring that it does its job, has reduced maintenance, and provides for fish passage. It is important to get the location right. Choose a site, if possible, on a straight section of river where it will not alter the natural course and gradient of the river channel. Avoid long steep road approaches, as these are ongoing sources of sediment. Finding a crossing which meets these criteria will reduce scour of the approaches, and erosion of the banks and river bed. It is also best to make sure there is enough room to design approaches that are perpendicular to the river, so that water does not get directed to either end of the structure. Again, always refer to the NES-PF rules at the planning stage.

Make sure the carriageway is high enough, so

that the crossing is safe to travel on during moderate flow conditions. This will reduce crossing closures that would otherwise be highly disruptive to traffic. Also, it is important that the approaches have acceptable gradient and transitions so that vehicles, especially low loader transporters, are not grounded. Note that where the height of the structure is greater than 1.5 m above the river bed, a building consent will be required.

Determine the correct type and size of culvert pipes for the structure. Reinforced concrete pipes have very good hydraulic characteristics because they are smooth, and have a high load bearing capacity. They may create a barrier to fish passage, however. Calculate the flood design, and use engineering formulae to determine the required culvert size. This includes considering the contributing catchment area and average annual flow. It is essential to design the structure to resist hydraulic pressure and erosion effects during flood flow conditions or debris flows. Major damage of the battery crossing will occur if they are not built to be robust. This may require reinforced aprons or deeply set rip rap on the outflow of the crossing. Also, it is critical to design to resist damage or blockage from woody debris. This may require the design of flared or chamfered culvert inlets or slash deflectors.

It is always good to look at existing structures, where present, to see what design features



Left: The deflectors have effectively limited the amount of woody debris caught in the structure. Right: The reno mattress has protected the same crossing from being undermined, but could cause a fish passage issue if not addressed

8. River crossings – continued

worked well, or not so well. For example, to assess the culvert pipe size against that derived from the flow calculations.

Given the costs and risks involved with battery culverts, it is recommended that the crossing design plans and calculations are peer reviewed. It is also suggested that in higher risk situations, or where a building consent is required, it may be necessary to consult with a forest engineer, hydrologist or other specialist to help with both design and construction. For additional information on how to calculate culvert size, refer to 8.9 Prediction of flood flows and sizing culverts, and Schedule 2 of the NES-PF for flood design flow calculators.

8.6.2 Battery culvert construction

As with all crossings, it is essential that construction occurs in suitable weather, and when the river has low-base water flow. Check for any fish spawning timing constraints. Restrict earthwork disturbance to the immediate construction site, which will include an area upstream and downstream of the crossing. Minimise the need for machinery to operate in flowing water. During construction, check regularly that the installation specifications and procedures are being followed, and signoff the work on completion of construction. If the work does not meet the design plan and standards, then initiate corrective actions.

The following are additional general construction good practice measures:

- Divert water flow around the construction site to assist in the foundation work, reduce the risk of contaminants entering the water, and minimise discharge of sediment
- Excavate the crossing bed, as required, to the correct depth and grade
- Wet or curing concrete must not be in contact with flowing water. Cement is a contaminant, and is toxic to invertebrates and fish. When pouring concrete, the water channel will need to be temporarily diverted
- Bed culverts so that they lie flat, and are supported on a firm or concrete base
- Elevated sediment discharge levels will

inevitably occur during construction. The NES-PF sets a permitted activity limit of no more than eight consecutive hours of elevated sediment. Any longer will require a discharge permit

- Reduce the risk of contaminants entering the water, for example, from the foundation work. Minimise discharge of sediment
- Ensure culvert pipes lie at or below the natural river gradient, to avoid creating plunge pool erosion in the bed of the watercourse at the outfall of the culverts. Also, one of the culverts must be at least 100 mm below river bed level, and located to carry low or base flow. This will allow for fish passage
- Take care not to damage the culverts during installation. Concrete pipes are heavy, hard to place into position, and need heavy equipment to transport, load, unload, and position them
- Protect the inlet and outlet of the structure. Armour outlets with concrete aprons, rip rap, reno mattresses or other energy dissipating structures. Inlets are best protected by having deflectors that force most woody debris up and over the structure
- Stabilise the banks upstream of the structure inlet, if necessary, to prevent bank erosion
- Use clean gravel on approaches where the existing road surface could create a sedimentation problem.

It is important to divert road water off the



Battery culverts must provide for the river's base flow, and upstream and downstream passage of fish; one pipe must be buried 100 mm into the river bed



approaches to minimise sediment entering the crossing. It is best to construct stormwater and sediment control measures as close as practicable to the crossing, and ideally within 10 m. For example, use berms, cut-outs, ditches and culverts, flumes and sediment traps. Build these above the annual flood flow level.

8.7 Drift deck river crossings

Drift decks, like battery culvert river crossings, are structures that are designed for flood water to overtop the carriageway. The main difference is that a battery culvert consists of a series of pipes embedded in concrete, whereas a drift deck is constructed with a series of open-bottomed, inverted 'U' precast concrete components, or a series of rectangular concrete box segments. Each box segment is secured to the adjacent box segment for the length of the structure. Those with an open bottom typically need a concrete base or piers for support, and as an anchor. Alternatively, cast in-situ piers with precast concrete bridging slabs may be employed. Some New Zealand manufacturers make proprietary interlocking components. For example, Hynds Pipes Systems Ltd.

Drift decks have similar advantages and disadvantages to battery culvert crossings; see previous section. However, they have

additional benefits, and potentially some weaknesses. They are typically less expensive, and the structure is not as susceptible to debris blockage because water can pass through a larger cross-sectional profile. Their prefabricated construction eliminates the need for concrete formwork and pouring, and makes them quicker to construct, often with less in-river construction disturbance.

Open-bottomed drift decks also have improved fish passage. A significant advantage is that, in some situations, the design may allow for removal after harvest for use at a different site. When the crossing is no longer required, the open bottom and concrete bridging slabs can be lifted from the river bed and re-used elsewhere, leaving the piers in place for the next harvest rotation. A potential disadvantage over a battery culvert, is that they may not be as 'bomb proof' in storm floods, depending on their location and design. For example, inlets are more challenging to protect from large woody debris than a battery culvert, as they cannot be deflected as easily.

As with all river crossings, understand the NES-PF specific rules for drift decks. Resource consents will be required where the drift deck does not meet the permitted conditions. For example, as for battery culverts, if the contributing catchment is greater than 500 ha.



Left: A well-constructed drift deck. Right: A drift deck crossing, with a secondary crossing for tracked logging machines that would damage the concrete pad

8. River crossings – continued

8.7.1 Drift deck design

The design requirements for drift decks concerning location, approach layout, grades and transitions, carriageway height and culvert size calculations are similar to battery culvert river crossings. These were discussed in section 8.6. It is important to determine the correct type and size of the drift deck sections for the site. For drift decks sited on steeper gradient and larger rivers, be aware that the NES-PF's permitted activity rule requires the use of two discrete footings to create an open bottom crossing with undisturbed fish passage if the bankfill channel width is greater than 3 m, and the bed invert gradient is greater than 6%, as measured 50 m up and downstream of the crossing site. Also, note that a building consent will be required if the height of the structure is greater than 1.5 m above the river bed.

As with other crossings, it may be a good option to consult with a forest engineer, hydrologist or other specialist to help with both design and construction of the structure. It is always a good idea that the design plans and calculations are peer reviewed. Additional information on how to calculate culvert size refer to 8.9 Prediction of flood flows and sizing culverts, and Schedule 2 of the NES-PF for flood design flow calculators and/or streamexplorer.niwa. co.nz.



8.7.2 Drift deck installation

The general construction requirements of the drift deck are the same as a battery culvert (see 8.6.2 Battery culvert construction). Some additional specific construction practices follow:

- Divert water flow around where the piers are to be constructed, if these are to be used
- Join the sections. Drill holes at each joint location, align drift deck units at the correct centres, insert dowels, then grout
- Complete the deck by fixing timber kerbing, where required.

Open-bottomed structures need the following preparatory steps:

- Construct on a suitable foundation slab or piers
- Construct level bearing pads at locations to match the drift deck unit's size.

Check regularly during and on completion of construction. If the work does not meet the design plan and standards, then initiate corrective actions.



Left: Drift deck outflanked by the river. (Credit: D. Nielson). Right: Drift deck components ready for installation



8.8 Single span bridge river crossings

Permanent forestry bridges in New Zealand are normally used on arterial roads, and on some secondary roads where it is essential to maintain access. Bridges are used on forest roads when the site conditions or the river size preclude the installation of a culvert or other type of crossing.

Bridges have advantages and disadvantages when compared to other river crossing structures. Their strengths are that they can:

- Span steeply incised rivers, or those with high river banks, to improve crossing egress or eliminate fill over a culvert
- Provide unrestricted vehicle access across rivers that have large and variable water flow, unlike fords, battery culverts or drift decks
- Cross rivers with high bed load and debris



Terms commonly used in bridging

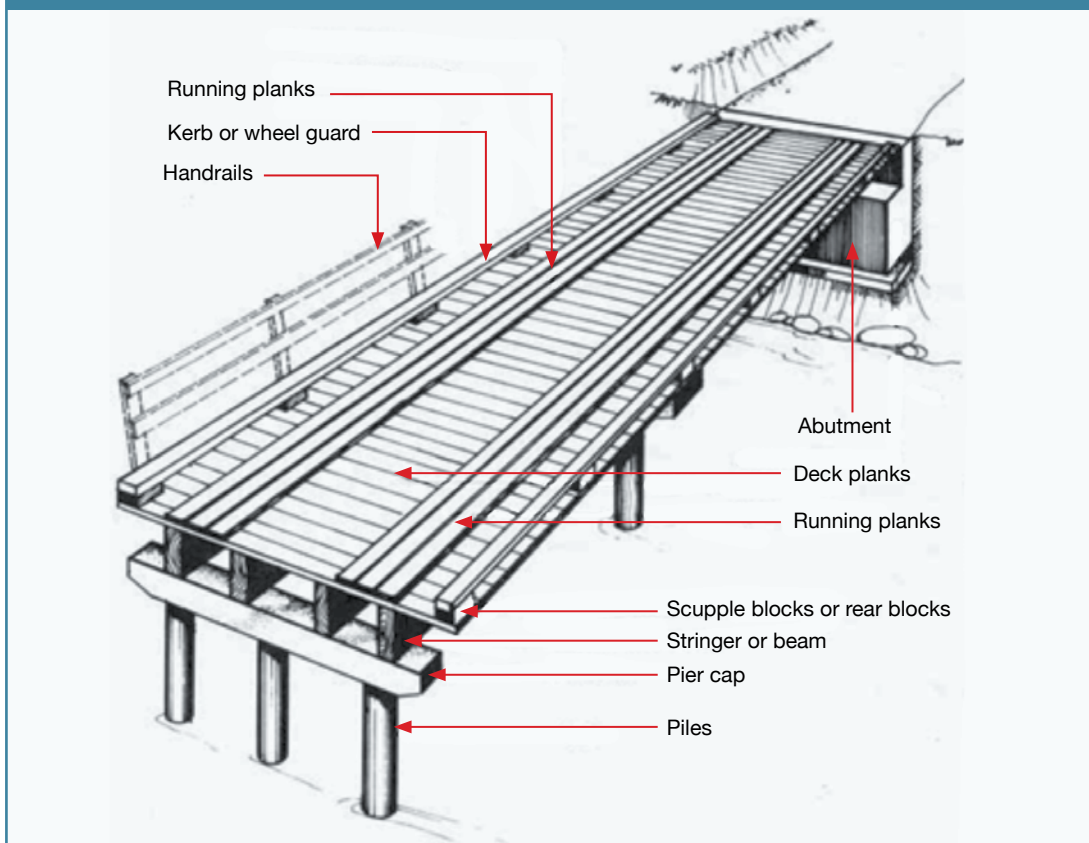

8. River crossings – continued

- potential, where a culvert would likely block
- Be used on a sensitive river bed, and banks that require minimal disturbance. Bridges can avoid or reduce river bed and bank disturbance during construction, and throughout its service life
- Cross high gradient, high energy river sections, where culverts are less suitable
- Reduce erosion, as the channel capacity is not restricted by structures within the river bed
- Be relatively low-maintenance in comparison to other crossing structures.
- Provide barrier-free fish passage
- Be used where other crossing types will be unacceptable.

Their disadvantages include the following:

- Are more expensive than other options, generally
- Require specialists to provide structural design
- Installation typically requires a crane for pile driving and beam placement
- Require enough beam clearance so that floating debris can pass underneath, otherwise they can fail
- May have gross vehicle mass restrictions. This can limit transporters and heavy logging equipment
- May require significant abutment scour protection and maintenance.

8.8.1 Types of bridges

There are a variety of bridges used for forestry purposes. Beam and deck construction are common. Beams are usually steel 'I', stressed concrete, steel truss, post-tensioned treated LVL or glue-laminated treated sawn lumber. Decks are prestressed concrete or timber. Shorter decks may be made from concrete slabs. Bridges typically cost more to construct than culverts or low-level crossings. In some instances, temporary portable bridges are used for short-term harvesting and transport access. These are designed for rapid construction and dismantling. Most consist of prefabricated combined beams and decking.

In some instances, temporary portable bridges

are used for logging traffic for short-term harvesting and transport access. Bridges typically cost more to construct than culverts or low-level crossings.

Bridges come in many different structural forms. They also use many material types. The most common types and typical applications are as follows:

- **Steel I Beam:** These are the most common bridge type. They are cost-effective for spans up to 20 m. A timber or concrete deck may be used. However, a concrete deck has the advantage that it may be designed to act compositely with the beams to increase the bridge load capacity. Steel beam bridges will require corrosion protection and maintenance, and are less appropriate in high corrosion sites, such as coastal or geothermal areas
- **Glulam timber beam:** These are a cost-effective option for spans up to approximately 12 m. Properly treated timber bridges perform well in high corrosion zones. They can have timber or concrete decks
- **Concrete beam:** Various forms of stressed concrete beams, including I beams, Double-Tee and hollow-core beam configurations, are common. They are typically suitable for spans up to 25 m. Very durable, but because of the high weight, they require more extensive foundations
- **Steel truss:** Generally, forest steel truss bridges consist of a truss below deck level and a concrete slab deck. The traditional Bailey bridge is a steel truss bridge with



Steel truss, concrete slab bridge



the trusses above deck level, and the deck supported on transoms. Steel truss bridges are suitable for spans up to 30 m or longer

- **Log bridge:** Use of round log beams as a bridge can be a cost-effective option, especially if suitable hardwood trees are available in the forest or CCA treated power poles are locally available. Log bridges are generally used for short-term applications, such as during harvest, but if appropriately durable timber is used, and good attention is given to construction detailing, log bridges can provide permanent crossings.

8.8.2 Single span bridge design

Bridges require specialist engineering design, and construction supervision. Do not attempt design and construction unless you are a trained, suitably experienced and qualified engineer. Also, almost all bridges will require a building permit and code compliance certificate under the Building Act 2004 from the district council. Understand the NES-PF specific rules relating to bridges, as a resource consent will be required where it does not meet the permitted activity conditions. An experienced bridge design engineer will be able to advise on the most appropriate bridge type, and prepare a suitable design for forest bridges. The investigation, design, consent and construction process for a forest bridge can take a significant time period. The engineering design may call for a multi span bridge with piers, meaning that a resource consent is required. Bridges need to be planned and scheduled for construction well in advance of harvesting activity.

It is best to locate the bridge crossing site, if possible, at a narrow point on a straight and uniform reach of river, that has stable river banks at and upstream of the bridge site, to reduce scour of the abutments or bridge approaches. Both abutment protection and span length affect cost. Also, try to make the crossing is perpendicular to the river, which will reduce span length.

Permanent bridges must pass at least a 1-in-50-year flood event (2% AEP), although it is best to allow for a 1% AEP for many bridges. This means that there is a 1% chance of the design flood happening in any year. Allow at least 1 m

of freeboard above the calculated maximum water level, to ensure floating debris does not damage the structure, or design the bridge to allow for overtopping. Avoid bridge design that places structural foundations on soil susceptible to erosion or structural failure. Bridges are long life structures so factor in potential natural channel adjustment changes over the bridge's design life.

The design of the road approaches can limit sediment entering the river, and minimise the potential for aggregate being tracked onto the bridge. Include in the design raising the bridge deck slightly or lowering the road approaches, to direct stormwater away from the river, if possible. Design to divert road surface water off the bridge approaches, as close as practicable to the bridge, and ideally within 10 m. Use stormwater and sediment control measures such as berms, cut-outs, ditches and culverts, flumes and sediment traps. Use clean gravel on road approaches where the existing road surface could create a sedimentation problem.

Bridge design requires the consideration of several important factors. These include:

- **Waterway clearance:** Because of the high value of bridges and the long life, they are typically designed to have enough waterway capacity to pass a 100-year (1%AEP) flood flow with additional clearance under the beams to enable passage of floating debris
- **Deck width:** Single or two lane, and of sufficient width for large equipment such as haulers and skidders
- **Deck load capacity:** Logging truck capacity or additional capacity for haulers and/or off-highway stem trucks or overweight vehicles
- **Period required:** For short-term harvesting requirements, re-locatable temporary bridge options are economic. Steel beam bridges and steel truss bridges, with precast concrete or timber decks, can be easily dismantled and shifted to new sites
- **Durability:** In high corrosion sites, or where long-term high traffic use is proposed, more durable materials that are less subject to fatigue are likely to be more economic.

8. River crossings – continued



Left: Bridges can become part of a debris flow even in a well-sited location. Make sure the bridge soffit is at least 1 m above a 2% AEP event. Right: The replacement is a metre higher

The NES-PF has specific regulations for single span bridges. Always refer to the NES-PF before design. For example, bridges must not decrease the bankfull channel width or restrict flow width by more than 10%.

Other reference material includes the NZTA bridge reference manual, see www.nzta.govt.nz/resources/bridge-manual/bridge-manual.html. Note that Appendix D, *Lightly Trafficked Rural Bridges*, may not be relevant due to logging truck use, and the potential for significant overloads caused by haulers on transporters, for example, crossing them.

8.8.3 Single span bridge construction

The normal river crossing tenets of constructing in suitable weather, checking for any fish spawning timing constraints under the NES-PF, limiting earthwork disturbance to the immediate construction site and minimising the need for machinery to operate in flowing water apply.

Additional specific bridge construction requirements include:

- Construct foundations onto non-erosion prone material, preferably rock. If this is not possible, then build to below the maximum level of potential erosion, or provide an acceptable alternate engineering solution
- Bridge abutments or footings should be on natural ground. This ensures that the length of

the bridge is wider than the river channel, and provides a good bed for the bridge

- Protect the abutments, footings and approaches. If necessary, armour with concrete, rip rap, gabions, wing walls and other deflectors
- Wet or curing concrete must not be in contact with flowing water. Cement is a contaminant, and is toxic to invertebrates and fish. When pouring concrete where it could enter the river, the water channel will need to be temporarily diverted



An option to concrete and steel – a New Zealand designed composite post-tensioned treated wood composite bridge



- Elevated sediment discharge levels may occur during construction, but must not occur for more than eight consecutive hours
- Check regularly during and on completion of construction. If the work does not meet the design plan and standards, then initiate corrective actions
- At the end of construction, all excess equipment and materials must be removed from the river bed within five working days.

8.8.4 Prefabricated concrete slab bridges

Prefabricated concrete slab bridges can be effective long or short-term solutions to crossing waterways. When short-term access is required for harvesting operations, portable or removable bridges may be an economic and environmental alternative to consider.

Portable bridges provide infrastructure flexibility. If used over several sites, the initial capital cost of



A crane will be needed to install and remove the structures

the bridge can be spread over all sites. They should be simple, rugged and lightweight. This makes them easy to transport from site to site. Spans of up to 25 m can be bridged with prefabricated beam structures. Environmentally, there is minimal waterway disturbance and the waterway is easily restored to its original condition. Portable bridges are designed for rapid construction and dismantling. Most consist of prefabricated beams and decking that is transported to the site and erected over the waterway on temporary foundations. Often temporary bridges can be erected using equipment typically available on forest sites. The foundations need not be as substantial as permanent bridges because temporary bridges are in place for a short term, where long-term settlement and ground movement risks are less of an issue.

All temporary bridges must have a building consent and code compliance certificate since they are subject to the Building Act.

8.9 Prediction of flood flows, and sizing culverts

To effectively design a river crossing, such as a culvert crossing, both the expected flood flow (design peak discharge) and the capacity for the stream crossing to pass the designed flood flow (see section 8.9.2), need to be known.

Flood flow is typically expressed in cubic metres of water per second (cumecs), for a given return period or annual exceedance probability (AEP). To calculate an AEP, divide 1 by the return period and multiply by 100. For example, a 1-in-20-year return period is equivalent to a $(1/20) * 100 = 5\%$ AEP.



8. River crossings – continued

The NES-PF regulations provide specific requirements for determining flood flows. It is essential that these are understood. However, prediction of flood frequency is not an exact science, and the selection of a design value for any particular site should be made carefully. For larger or more complex catchments, this should be done by an experienced hydrologist or forest engineer. The assessment should consider a range of factors including the characteristics of the catchment, the appropriateness of the model for the site being evaluated, and any local knowledge that can be obtained on historical flood events at the site.

Most forest river crossings are small and drain catchments that are unlikely to have recorded flow data. The flood frequency, flow rates and water levels of these small catchments are significantly influenced by the immediate catchment characteristics, and the stream profile. Where flood flow characteristics are not known, an estimate must be made. To do this, ideally two or more methods should be used, where available. Such methods include using historical stream flow data for a region (the regional method – see section 8.9.1), or rainfall data, together with catchment and river characteristics (the empirical method – see section 8.9.2).

It is also good forest engineering practice to verify flood estimates. This can be done by inspecting existing culverts and bridges on the same waterway, or on one similar to the proposed crossing site, to gain an indication of the approximate flood flow for known storm events. However, be cautious using this approach on large structures, as a rare flood flow, such as a 1-in-50 or 1-in-100-year event, may not have occurred since its installation. Statistically, there is only a 60% chance of experiencing a 1-in-50-year flood in any 50-year period.

8.9.1 Calculating flood flow using the regional method

Regional methods draw from New Zealand's network of long-term river gauging stations, by fitting the observed flood records to an extreme value distribution, then extrapolating them to a catchment for which no records exist. It predicts the mean annual flood (MAF) flow in a stream or river reach, then applies a regional multiplier to

estimate 1-in-10, 20, 50 and 100-year flood events.

Regional methods are well suited to rivers draining catchments larger than 1000 hectares (10 km²), and can be used with moderate confidence down to catchments of around 500 ha. These are often classed as third order streams.

The most current New Zealand regional method has been developed by NIWA. It uses the observed mean annual flood (MAF) statistics for 630 of the most reliable flow measuring sites in New Zealand, and is underpinned by 1:250,000 scale soil mapping (QMap) from GNS (Henderson and Collins, 2018). It is supported by twice as many sites, and three times the annual maxima than the previously available regional method (McKercher and Pearson, 1989). It also captures more extreme events. For example, the current version accounts for the markedly different rainfall runoff response associated with deep porous volcanic ashfall (pumice) soils in the central North Island.

The Henderson and Collins (2018) version is available through NIWA's 2019 online flood frequency tool. See www.niwa.co.nz/natural-hazards/hazards/floods; click on 'Go to the Flood Frequency Tool'. It allows the user to obtain an estimate for a range of flood flows of most rivers and streams in New Zealand. The NIWA online tool does not use the river network from the LINZ Topographic Map series, but rather uses its own digital terrain model (DTM) that supports their River Environment Classification (REC, Version 1). The REC DTM differs in the way it fits the modelled river network to the terrain, compared to the river location on the LINZ Topo Map series. In the example below, the fitted REC is represented by the purple lines, and the blue line is from LINZ Topo Map. REC does not model some small headwater streams.

The flow gauging stations are denoted on the map as red dots, and may be interrogated by clicking on that dot. In the 'pop-up' box, H_C18...., indicates flow estimated using this regional method for the selected reach. Scrolling down in the dialogue box gives the standard error in each of the estimates. Also, clicking on the arrow on the top bar toggles to the rational method estimate, but note that the values need to be extracted and multiplied by an appropriate

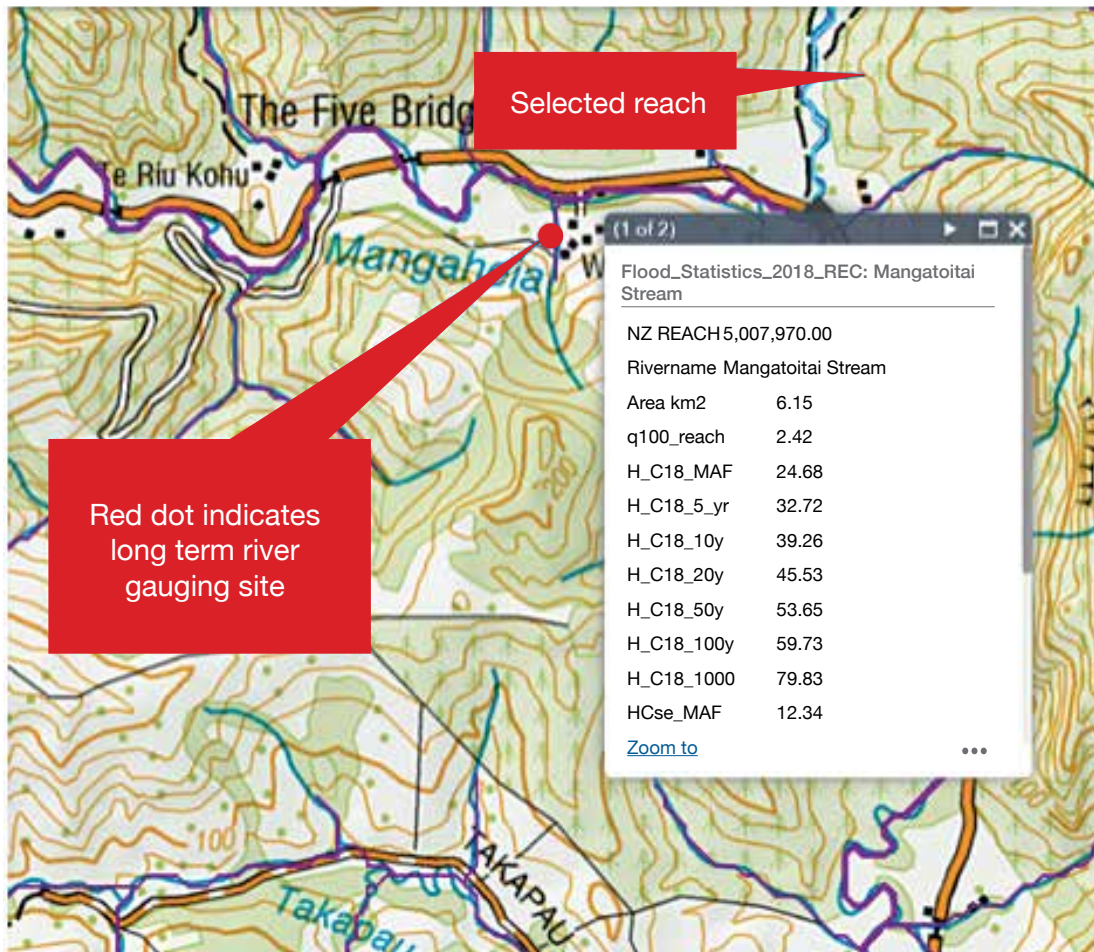

Screen view of the NIWA online flood flow estimation model

runoff coefficient (C). Refer to engineering or regional council texts for guidance.

If the model does not show a headwater or second order river present yet one has been identified, then it is reasonable to click on adjacent reach from a similar sized catchment to get flow estimates. Keep in mind that the modelled flow is always for the most downstream point in any given reach, so in very long narrow first or second order rivers, the contributing area, and hence the flood flow, may be substantially less at the top of the reach compared to the most downstream point.

It is recommended that this tool should only be used by those who are familiar with the assumptions and limitations in the underlying hydrological models. For example, the NIWA

regional model does not include factors for vegetation, unlike the empirical methods such as TM61 and the rational method. This is because in larger catchments factors such as rainfall intensity and geology (soil porosity and depth to bedrock) were found to be more significant in explaining flood magnitudes.

8.9.2 Calculating flood flow using empirical methods

Empirical methods predict flood flows from estimates of rainfall intensity for a given duration, catchment and river channel characteristics. The most widely empirical methods used in New Zealand are the rational method and TM61 (technical method 61 (1964)). The latter is a New Zealand variant of the rational method developed by the former Ministry of Works.

8. River crossings – continued

The rational method is considered a preferred method in catchments less than 120 hectares, as it is known to yield large (that is, very conservative) values for larger catchments. Both methods are known to provide more consistent results in more uniform terrain.

The catchment rainfall data, or an estimate of it, drives the empirical flood flow estimation methods (TM61 and rational method). Rainfall data can be sourced from the NIWA high intensity rainfall data system (HIRDS). Version 4 takes account of predicted climate change. Visit hirds.niwa.co.nz. NIWA provides help and background information at www.niwa.co.nz/information-services/hirds.

TM61 requires rainfall depth and the rational method requires rainfall intensity for a given duration. These formulas provide an estimate of the design peak flow for various annual exceedance probabilities.

The HIRDS coverage of derived rainfall depths for different durations and return periods can be download for use in ArcGIS from NIWA. Each surface contains rainfall depth in mm for a given average recurrence interval in years and event duration in hours on a 2 km grid. High intensity rainfall data is also available in the format of ‘depth-duration frequency’ and ‘intensity-duration frequency’.

Rational method

The rational method is the most commonly used empirical method and its origin dates back over 100 years. It appeals because of its simplicity. Assumptions on which the rational method is based include that rainfall is uniformly distributed over the catchment (which may not hold true in larger basins), that the catchment is impervious (with the effect of detention, depression and channel storage considered negligible), and that the whole catchment contributes to runoff. These are reasonable assumptions for small basins, especially when saturated from previous rainfall events. It is appropriate to use the rational method in small catchments (up to 120 ha).

The formula is most commonly written as $Q = CiA/362$, where:

- Q = peak discharge at design recurrence interval (m³/s)
- C = rational runoff coefficient (dimensionless)
- i = rainfall intensity (mm/hr) – for a calculated time of concentration (ToC) in minutes
- A = catchment area (ha).

The runoff coefficient C is a simple ratio between the depth of rain input and river outflow that occurs over various surface types when rainfall duration. The larger the C value used, the greater the modelled runoff. Chapter 5 of Keller and Sherar (2003) *Hydrology for Drainage Crossing Design* demonstrates how to use the rational method. While the original C factors ranged from 0.15-0.4 for forested catchments, the table below represents the values to be used in what is referred to as the modified rational method, and is expected to yield better estimates as it takes into account soil types.

Rational method values of “C”	
Land use or type	“C” value
Agriculture	
Bare soil	0.20-0.60
Cultivated field (sandy soil)	0.20-0.40
Cultivated fields (clay soil)	0.30-0.50
Grass	
Turf, meadows	0.10-0.40
Steep grassed areas	0.50-0.70
Woodland/forest	
Wooded areas with level ground	0.05-0.25
Forested areas with steep slopes	0.15-0.40
Bare areas, steep and rocky	0.50-0.90

Source: Keller and Sherar (2003)

If an entire catchment is to be clear felled over two or three years, in most situations larger flood peaks can be expected so it is prudent to pick a higher C value. This is because there will be less interception of rainfall by vegetation. For example, in a small catchment that is completely clear-felled it is appropriate to use C = 1.0 in most situations. However, in porous soils the factor may not be as much.

The NIWA online flood estimation tool implements the rational method using HIRDS



version 4, but only returns the 'iA' part of the equation. This leaves the user to specify C value, noting that the default value is C = 1.0.

Technical memorandum No. 61 (TM61)

TM61 was developed for New Zealand conditions in 1953 by the former Ministry of Works for use in smaller catchments; see *A method for estimating design peak discharge*,

(MWD 1980) (http://docs.niwa.co.nz/library/public/TM61_1980.pdf). TM61 typically relies on the use of nomograms or lookup graphs. This is because it was produced prior to computer technology, but spreadsheets that have converted these graphs to equations are also available. In order to use TM61, the following information is needed:

- Catchment area

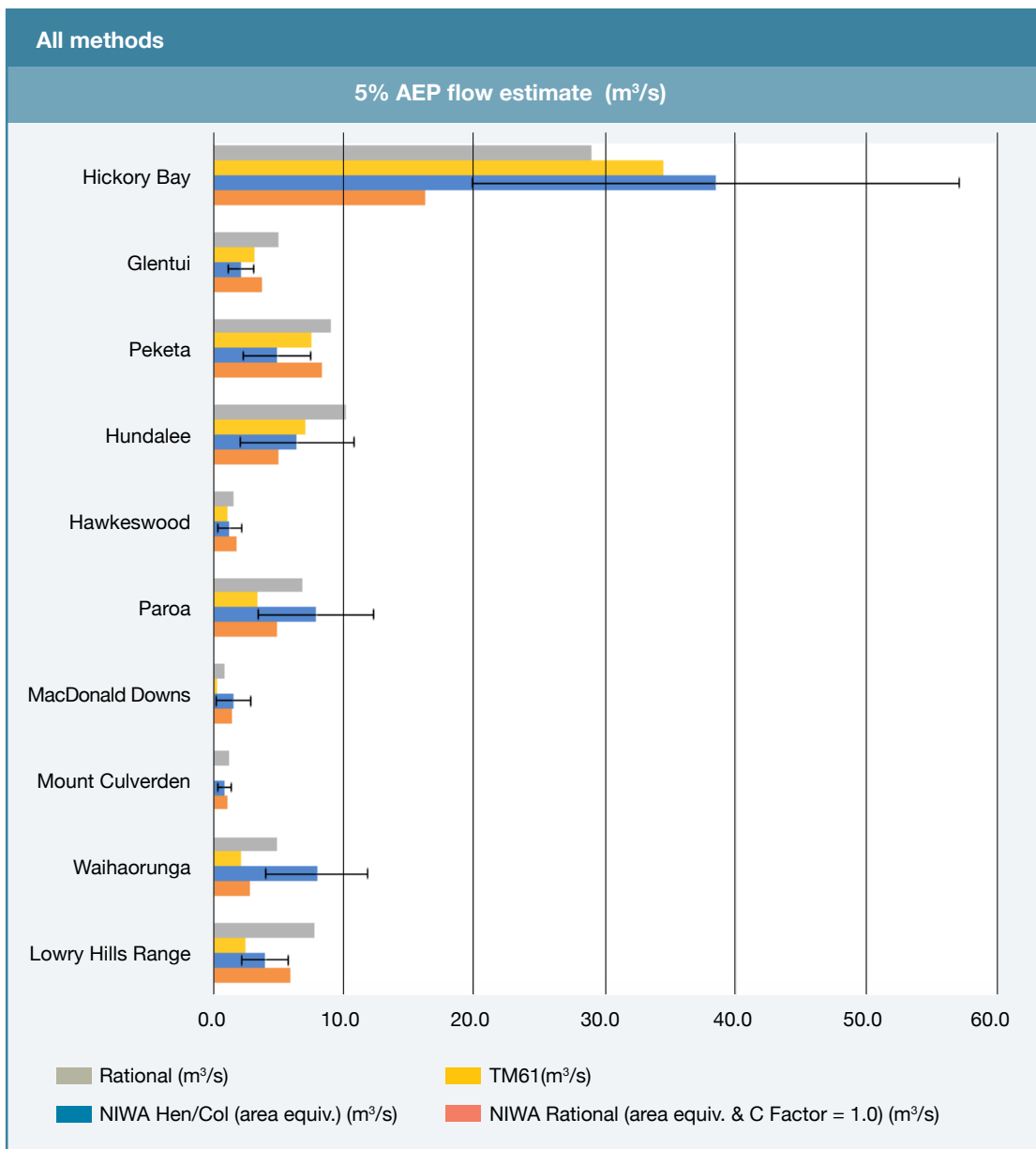

Flood estimates using Henderson and Collins (2018) regional method (the error bars indicate the standard error), TM61 and the rational method, where the runoff coefficient C was set to 1.0 to model a clear-felled catchment. (Analysis by Costley, 2019)

8. River crossings – continued



- Channel length
- Average channel slope
- Direct length (straight line distance from the culvert location to the most distant point in the catchment)
- Rainfall depth for the design storm event. For example, 20, 50, or 100-year event having a duration equal to the catchment time of concentration
- General information about catchment soil types, topography, and land cover (in small catchments it is best practice to design for worst case. That is, 100% clearfell.

TM61 requires selection of the appropriate infiltration coefficient' (W_{ic}), time of concentration (ToC) for the catchment and an estimate of average channel slope. The Environment Bay of Plenty (EBOP 2012) document *Hydrological and Hydraulic Guidelines* (www.boprc.govt.nz/media/373948/hydrological-and-hydraulic-guidelines.pdf) is a good reference and gives values of W_{ic} for various soil types. This is particularly important for pumice because it

has very different infiltration characteristics to impervious or saturated soils. Time of concentration (ToC) for a catchment is approximately the time required for runoff to travel from the most distant point in the catchment to the river crossing location. For very small watersheds, such as a few hectares, Keller and Sherar (2003) recommend selecting a minimum ToC of five minutes.

The different methods for estimating a flood flow yield can lead to different flow results. This is because their estimates are based on differing factors. For example, TM61 is expected to overestimate flow on porous volcanic soils, and to become less accurate on catchments larger than 1000 ha (Laurenson, Burton & Henderson, (1967). A University of Canterbury dissertation project (Costley, 2019) usefully demonstrates the variation in the three methods for 10 small catchments ranging from 33-700 ha. (See diagram page 173).

The Environment Bay of Plenty (EBOP) document stresses that professional judgement is needed when choosing an appropriate runoff coefficient, C and time of concentration.



8.9.3 Calculating culvert size

Having derived a flood flow estimate for a design peak flow (AEP), the next step is to work out a suitable culvert size.

The flow rate of water a culvert can pass depends on many factors, including not only the size of the opening, but also the length, the slope it is installed at, the material from which it is made, and the pressure that the water is under if it is allowed to 'head up'. Heading up refers to the water level being above the top of the culvert; this helps push the water through.

For forestry applications, a simplified chart (pages 84-86 of Keller and Sherar (2003)) is presented below that provides for a good culvert diameter estimate based only on:

1. Culvert type (Headwall and Wingwalls = Type 1, Mitered = Type 2, Projecting beyond the embankment = Type 3)
2. Heading up ratio (He/D). He is the depth of water; D is the diameter of the pipe. For culverts that are designed using the NES-

PF permitted category, the culvert is not allowed to head up and a He/D ratio of 1 should be chosen

3. He/D scales. To use Scales 2 or 3, project horizontally to Scale 1, then use a straight inclined line through Scales D (culvert diameter in meters) and Q (flow rate in cumecs).

EXAMPLE: How to conservatively estimate the correct size of a corrugated metal pipe culvert, with an inlet 'projecting beyond the embankment', in a stream with a peak flood flow in the range of 2 and 3.5 m³/s, and where the design does not allow heading up

Use the nomogram on page 176. Note that the lookup chart is only for corrugated culverts. A 'projecting beyond embankment' is a Type 3 shown at the bottom right of the chart. No heading up equates to a He/D ratio of 1.0, which is on the far-right axis. For a 2 m³/s flow event, the required corrugated metal pipe culvert diameter is between 1.2 and 1.3 m, that is, follow the dotted lower red. For a 3.5 m³/s flood flow event, the required pipe diameter is at least 1.6 m.



Choose the right type of culvert when calculating culvert size in the nomogram.

Headwater depth and capacity for corrugated metal pipe culverts with inlet control (metric system) (Adapted from FHWA, HDS 5, 1998)

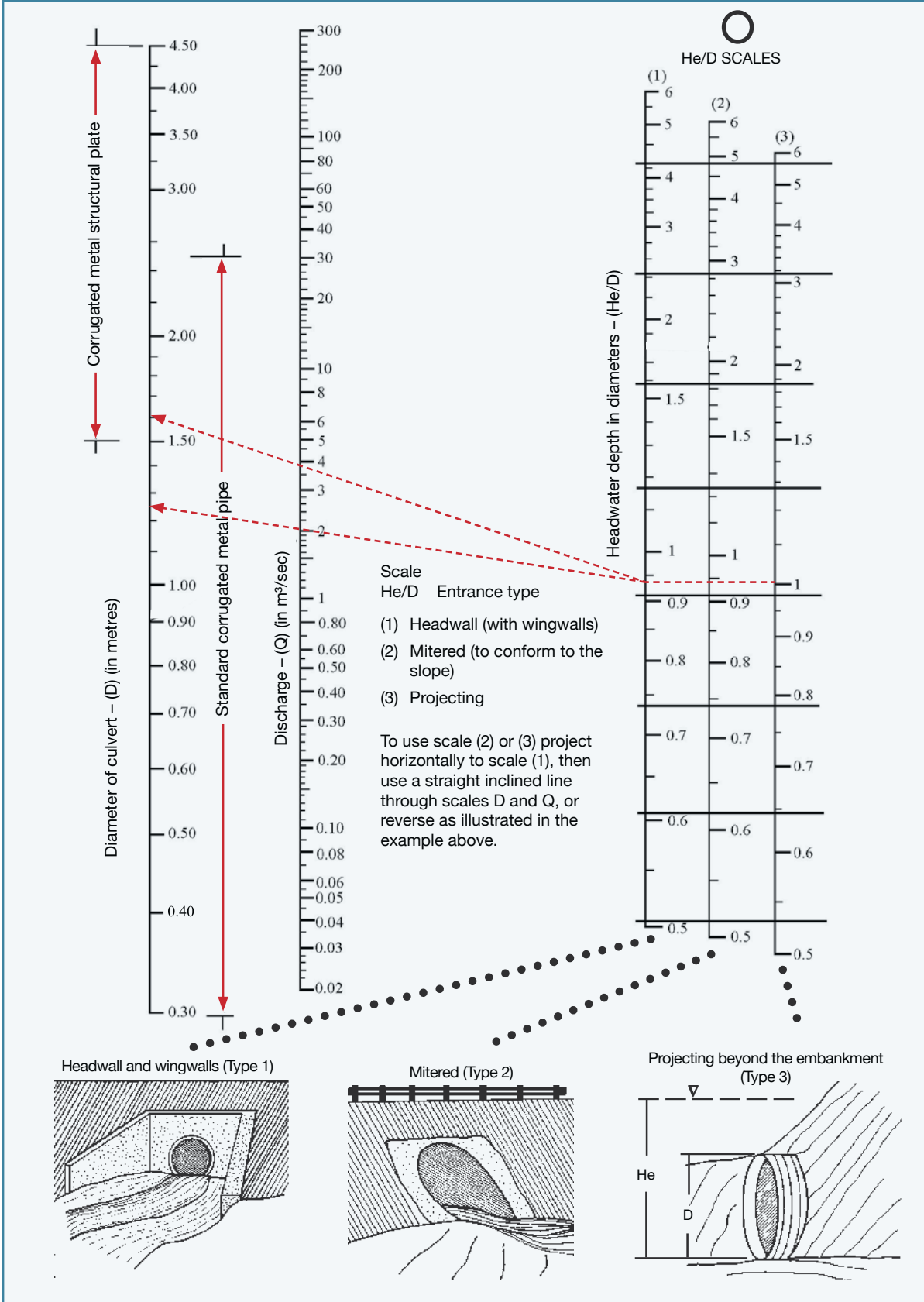



Headwater depth and capacity for concrete pipe culverts with inlet control
(Adapted from FHWA, HDS 5, 1998)

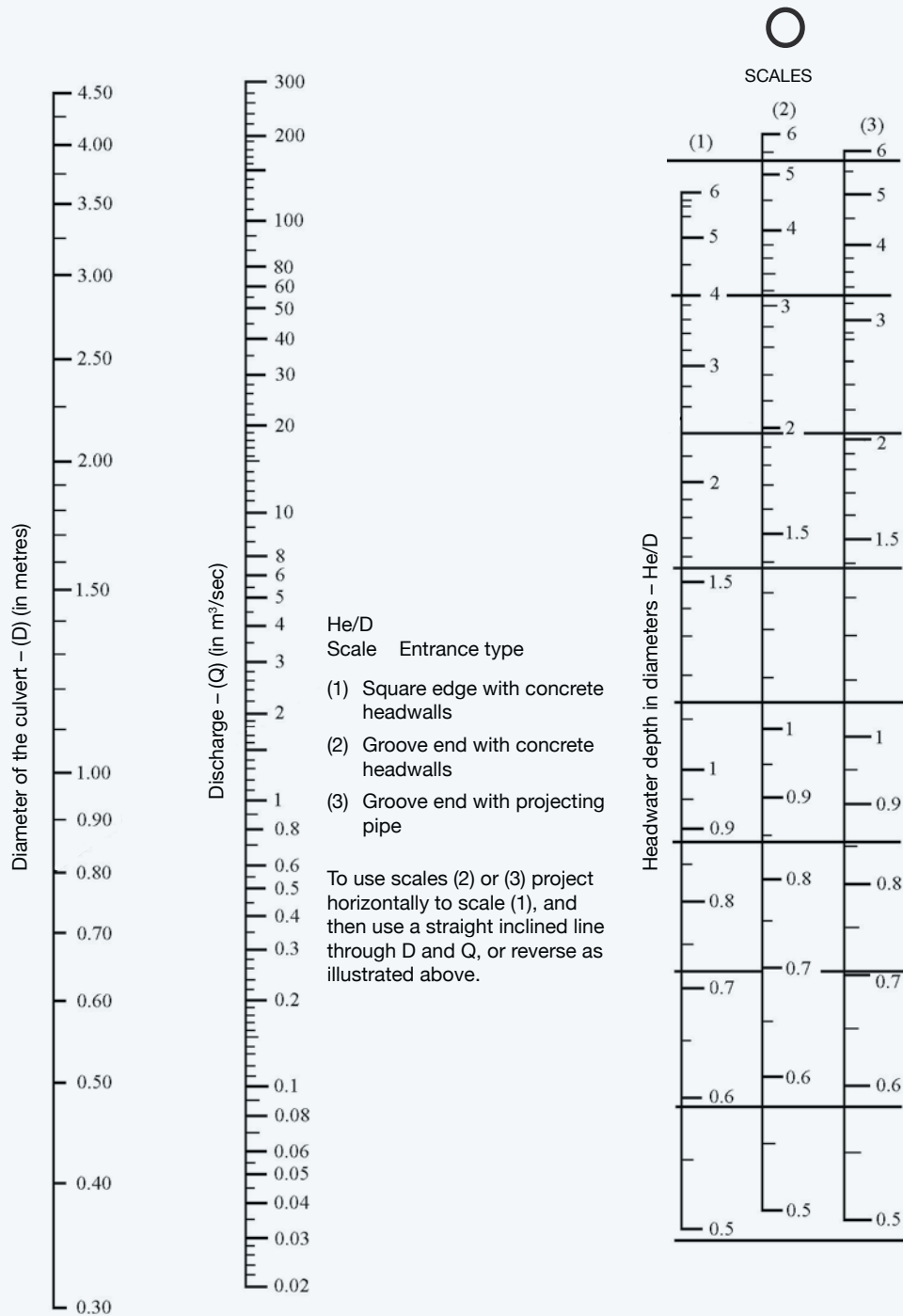

8. River crossings – continued

8.9.4 Acceptable risk of a given flood exceeding the river crossing design parameters

A risk-based approach is normally used in the design of river crossings. In steep hill country, it is generally not practicable to design a culvert crossing to cope with the maximum creditable flood or debris flow that an exceptional storm may generate. Bridges and culvert sizes must instead be designed to meet or exceed the standards specified in the NES-PF. Generally, a minimum 50-year design life will be adopted. A forest owner will typically accept a greater risk of a crossing failure on a spur road than on an arterial road.

Flood recurrence interval (years) in relation to design life and probability of failure*							
Design life (years)	Chance of failure (%)						
	10	20	30	40	50	60	70
	Recurrence interval (years)						
5	48	23	15	10	8	6	5
10	95	45	29	20	15	11	9
15	100+	68	43	30	22	17	13
20	100+	90	57	40	29	22	17
25	200+	100+	71	49	37	28	21
30	200+	100+	85	59	44	33	25
40	300+	100+	100+	79	58	44	34
50	400+	200+	100+	98	73	55	42

Based on formula $P = 1 - (1 - 1/T)^n$, where n = design life (years), T = peak flow recurrence interval (years), P = chance of P = chance of failure (%). (Source: Megahan, 1977)

The table on the left indicates the chance of failure in a flood of a given recurrence interval. Note that this does not imply catastrophic failure, but rather the chance of a culvert not being able to pass a flood without overtopping, and the road fill sustaining some scour. For bridges there is a chance of abutments being scoured or the bridge superstructure being damaged by woody debris carried in the flood flow. The designer should also consider the consequences of a partial or complete blockage of a culvert by tree fall or logging slash. The likelihood of failure in forested catchments, especially after harvest, may be greater than that shown in the table because of additional factors like blockage or damage by woody debris.

Example

Using the table on the left, if a road culvert is expected to last at least 25 years and the forest owner will accept no more than a 40% chance of failure during the road's design life, then a 50-year recurrence interval flood event should be used in the design for sizing that culvert. The table shows it as a 49-year event, which is close enough given all the other uncertainty in the design. Refer to www.fao.org/docrep/006/t0099e/T0099e04.htm.



Chapter 9

Road maintenance, repairs and upgrades



9. Road maintenance, repairs and upgrades

It is said that drainage, drainage, drainage are the three factors that will help maintain roading infrastructure. Unsealed roads are very susceptible to rapid deterioration caused by traffic damage, and water entering the pavement. A well-drained road, with appropriate water control structures and vegetative erosion controls, will not only maintain higher pavement strength and require less maintenance, but will also reduce erosion and control sediment.

Poor design and construction, and the impact of frequent trucking associated with harvesting operations, will accelerate the need for repairs and maintenance. A minimum level of service indicator should be developed for each infrastructure type. This is the standard beyond which the structure is not allowed to deteriorate before maintenance is required.

There are three major post-construction activities that can occur on a forest road. These are road maintenance, road repair and road upgrade. Often the first two are considered jointly as repairs and maintenance. All roads need maintenance at regular intervals. Road repairs are typically carried out during and immediately after harvesting, during which intensive trucking will have caused damage over and above the normal ongoing 'wear and tear'. A road upgrade is normally associated with bringing a substandard road up to a level where it can take logging traffic, or to a higher road standard category. Examples include an access track used for forest establishment and silviculture being widened and its alignment improved, or a secondary road upgraded to an arterial road to accommodate more extensive truck movements.

9.1 Maintenance programme

Research shows that it is far less expensive to keep a road in good condition than it is to repair it once it has deteriorated. Road maintenance is about the life of the road. Roads are maintained to:

- Prolong their life
- Save money in the long-term, by rectifying damage before major rehabilitation is required
- Increase operator health, safety and comfort
- Minimise environmental impact
- Guarantee easy access for emergency services and for forest protection. For example,

ambulances and firefighting equipment

- Reduce vehicle operating costs.

Pavement management systems are widely used to keep track of roads and their conditions. They provide an inventory of road condition, a priority rating of the importance of each road, a maintenance schedule to keep certain roads in good condition, and a schedule of repairs of lower rated roads for when funding is available.

Maintenance requirements on each road class are likely to vary, and can be classified into two categories – preventative, and on-demand corrective. The maintenance strategy adopted will be determined by the importance of the road link in the network.

Arterial roads generally require frequent maintenance. They are the major feeder routes into and out of the forest block, so must remain open. Preventative and on-demand maintenance is necessary.

Secondary roads also typically require frequent maintenance. They link spur roads and arterial routes. Most secondary roads have a steady flow of both heavy traffic and light vehicles. Spur roads are usually only repaired during the period they are required for harvesting operations. The level of maintenance required is minimal, depending on the level and frequency of use. During harvesting, wood extraction operations may result in high numbers of heavy vehicle movements on the roadway, whereas during other periods, only light silvicultural traffic movements are likely. Some companies may stop maintaining these roads if they do not provide strategic access, and do not increase safety, environmental or fire risk.

Establishment tracks generally require little, if any, maintenance as there is infrequent and light vehicle use, so vehicle damage is minimal. However, keeping access open should be considered if they provide access for firefighting.



9.1.1 Preventative maintenance

Preventative maintenance is routine maintenance carried out on the road from the time it is constructed. This is to help prevent major defects, and pavement damage from occurring. It is about preventing any road failure, so works occur when any weaknesses first show rather than when it becomes urgent. This prolongs the life of the road but may also have a high cost, since it requires regular inspection and a high ongoing demand on resources. Preventative maintenance has the following characteristics:

- Typically, a higher total road management cost
- An increased service life of the road
- Reduced vehicle operating costs
- An increase in safety for road users
- More consistent use or allocation of maintenance resources.

If defects are left too long, they can cause severe damage that may require extensive pavement rehabilitation. Failure to undertake preventative maintenance – such as culvert entrance clearance – may result in significant environmental damage and greatly increased rehabilitation costs.

9.1.2 On-demand corrective maintenance

On-demand corrective maintenance is irregular maintenance needed to correct defects as they are identified. This level of maintenance may incur lower ongoing cost, but may result in the need for major rehabilitation earlier than otherwise necessary.

On-demand maintenance procedures can:

- Reduce the overall efficiency of maintenance resources, with more urgent repairs becoming necessary
- Result in higher vehicle operating costs.

The challenge with corrective maintenance is if the maintenance is held off and not scheduled when road degradation starts, then it can rapidly spiral into expensive road repairs.

9.2 Economic evaluation of road maintenance projects

An economic evaluation incorporates the road's life cycle costs to help justify the maintenance programme. It will support the financial implications of the what, when, where, why and how type questions. Alternative maintenance scheduling scenarios can be compared to help decide the best use of resources. It is also useful to evaluate road user and authority costs. The evaluation often considers the whole road network, and associated budget constraints and projections.

A key decision that economic evaluation can assist with, is determining how much preventative versus on-demand maintenance is justified. The two diagrams on page 182 show the relationship between user costs and the serviceability level for two maintenance strategies. The first shows an on-demand maintenance strategy with major resurfacing required when the serviceability level falls below the terminal level. The second strategy shows preventative maintenance being conducted, effectively increasing the length of time before major reconstruction is required. However, more costs are incurred by the road user as maintenance is more frequent.

The terminal level is set by a mix of legal, regulatory or company thresholds at which the road can no longer meet its intended purpose. One of the following factors will determine that the pavement requires rehabilitation:

- Serviceability falls below the minimum acceptable level
- Structural capacity is inadequate
- Safety is inadequate
- Environmental standards are unacceptable
- High maintenance costs.

All costs associated with the road need to be evaluated to make a valid economic assessment. They need to be assessed over the life of the structure. Discounted cash flow analysis is required so that all expenditure and income occurring over the road's lifetime, or analysis period, is adjusted to a common base time or value.

9. Road maintenance, repairs and upgrades – continued

The relationship between costs and serviceability

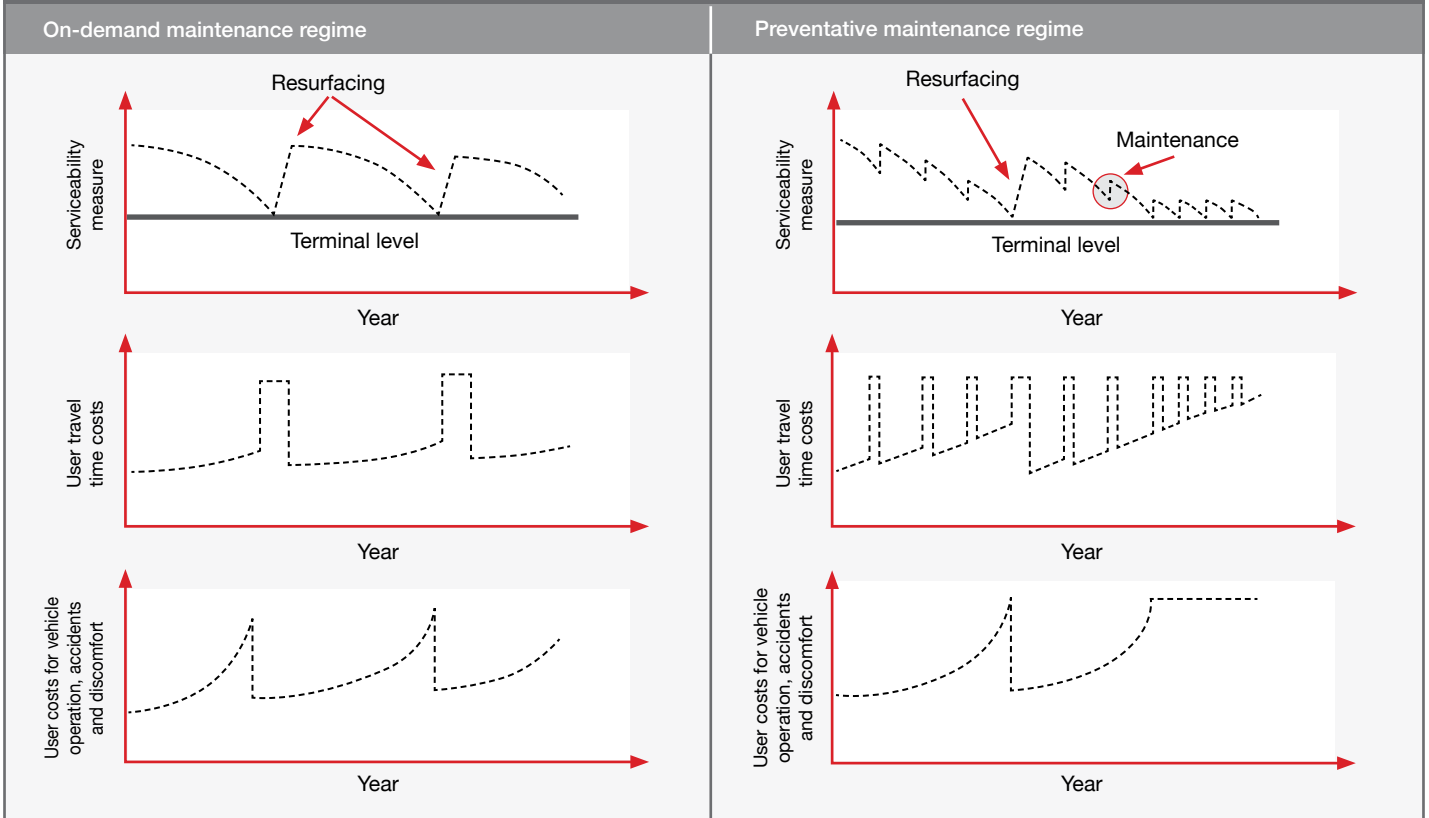

The formulae associated with economic analysis will not be covered in this Manual. There are numerous specialist books on the subject. Refer to Chapter 1, which further covers the factors to consider in an economic analysis.

Rehabilitation of a pavement usually means construction work is needed to stabilise, reshape and rejuvenate the pavement to increase user safety, and decrease user and maintenance costs. This is usually taken as the end of a pavement's useful life, and a new economic analysis is completed for the next design period.

9.3 Managing maintenance requirements

To ensure that a road is correctly maintained, regular inspection is required to identify problem, or potential problem, areas. Various techniques can be employed for pavement

inspection, including a regular inspection schedule based on the traffic volume, axle weights, and pavement material used. Alternatively, a road condition rating system (RCRS) can be used. These tools use rating indices to quantify the road pavement condition.

9.3.1 Inspections

Roads can be inspected regularly, or after a storm or an extended wet period. The results from these surveys should be used to develop a maintenance plan. Features which should be noted during an inspection include:

Pavement surfaces

- Flat crown
- Depressions
- Potholes
- Soft spots
- Shoving



- Slippery surfaces.

Unsealed shoulder surfaces

- Ruts
- Potholes
- Soft spots
- Low and high shoulders
- Scouring.

Grassed shoulder surfaces

- Build up
- Soft spots
- Poor slope
- Ruts
- Debris
- Height of grass.

Water channels

- Debris build up
- Blockages
- Scour
- Vegetation growth
- Culvert entrance debris accumulation
- Bridge waterway erosion or accumulation of debris.

Other

- Signage. This must comply with the *Approved Code of Practice for Safety and Health in Forest Operations (WorkSafe)*
- Excessive dust
- Encroaching vegetation
- Bridge structure damage, cracking, rotting or corrosion.

In wet conditions the following features become more obvious

- Ponding – on the road surface and in the ditches
- Surface flooding
- Blockages
- Leaking flumes
- Leaking culvert joins
- Seepage up through the pavement
- Water runoff across the road instead of into the ditch.

9.4 Commonly used maintenance machinery

Match as best as possible the available machinery with the maintenance task. This will ensure the job is done to specification, and efficiently. An experienced, trained operator will generally do a more cost-effective and better job. They will also be able to anticipate potential issues that may reduce the amount of future maintenance.

Routine maintenance normally involves the following machinery:

Light grader: Used to reshape the road, grade out any corrugations, ruts, potholes and produce a quality running surface. They can also be used to clear out certain types of ditches

Excavator: Used to excavate any soft spots within the pavement, and to clear out culvert inlets, outlets and ditches. Cleaning out sediment traps can also be completed with an excavator

Gravel trucks: Used to deliver material for replacing soft spots, and to spread gravel over the road replacing any lost running surface material. Bottom dumpers are often used because of their increased accuracy and higher production rate

Front-end loader: The wheeled front-end loader can be a useful maintenance machine, as it can easily travel along road segments thus reducing the amount of transportation required. Used for small excavation jobs, where the material is either loaded onto trucks or transported a short distance by the loader

Rubber tyre roller: Can be either towed or self-propelled. They are used to compact and seal the surface of a pavement that contains well-graded material

Smooth drum steel roller: These can be static or vibrating. They also compact and seal the pavement in situations where there is a high proportion of large material and a small proportion of fines.

Water cart: Used to apply water to the pavement so that compaction can be achieved at optimum moisture content. They can also be used to apply dust control and stabilisation agents.

9. Road maintenance, repairs and upgrades – continued



A front-end loader and truck are good for some jobs. A wheeled excavator with an angled bucket or a smaller tracked excavator with an offset boom is cost effective and versatile

9.5 Road surface maintenance

Surface defects affect the top running surface of a pavement. These defects lead to discomfort for drivers and damage to vehicles and goods. They can eventually lead to greater pavement, or even subgrade, defects. Surface defects include corrugations, scour or ruts, and potholes.

9.5.1 Corrugations, potholes, and scouring

Corrugations are parallel ridges that lie at right angles to the direction of the traffic. They are often located on steep roads, particularly around corners, and are caused by vehicles bouncing as they travel over the pavement. The mass of a vehicle can determine the level of movement – a loaded vehicle will cause little damage, whereas an unloaded vehicle will bounce significantly more, especially when travelling up slopes. Once corrugations start to form, they induce further vehicle movement which increases the rate of damage to the pavement. Any irregular surface feature will initiate vehicle vibration, causing corrugations to occur. The type of vehicle suspension can also contribute to the problem. In dry conditions, using a grader to cut to the depth of the corrugation and respread the material usually rectifies the problem, as the underlying material beneath the corrugations is usually not affected. In wet conditions, the

corrugations sometimes move lower and deform the base course and lower pavement layers. In these cases, the pavement should be left to dry, and reshaping and compaction of the material will be required to form a surface for water runoff. Longer-term corrective measures include the addition of a clay binder, or lime stabilisation of the pavement, and using higher quality crushed aggregate for isolated trouble spots. Where corrugations occur at the approaches of bridges, on steep grades, or on low-radius curves, sealing will provide the necessary control. There are several ways to prevent corrugations from forming, especially in critical problem areas like steep corners. Lightweight drags towed behind a vehicle can be an effective preventative treatment. Other equipment, such as a lightweight grader, or brushes attached to, or pulled by, a utility or tractor can be used to pass over the surface on a regular basis. Compaction after maintenance grading may also help.

Potholes are holes formed in the upper surfaces of the pavement. They generally occur in wheel paths in low lying areas, in shaded areas where the road is constantly wet, or where there is little or no crossfall. For example, at bridge approaches and intersections. Potholes are generally caused by poor pavement drainage due to low (or nonexistent) crossfall. Water will lie on the



Potholes retain water that penetrates the aggregate, causing a further reduction in strength

surface of the pavement, and seep into the top layers. Movement of vehicles over the area strips the surface material, allowing more water to enter the pavement. Fine material is then suspended in the water and carried away. The only remedy for potholes is to restore the crossfall and superelevation to its original level, to ensure adequate drainage. This can easily be achieved by cutting the surface and grading the pavement back to a correct crossfall. In severe situations, new material will be required to replace what has been lost and mixing and reshaping is required. Potholes can be prevented by

increasing or constructing crossfall. This will encourage water runoff. Also, stabilisation of the pavement, or the use of a moisture retardant, can be used in areas where the pavement is constantly shaded and wet.

Scouring can occur along and across the pavement. Scouring not only causes traffic problems but also opens the pavement to the weather, which may cause further deterioration and defects. Pavements with high fine contents, and small aggregate sizes and insufficient binding, are more susceptible to scouring. Scouring is caused by the flow of water over



Left: Scouring can rapidly occur during heavy rain. Right: Good crossfall helps reduce scouring

9. Road maintenance, repairs and upgrades – continued

the pavement, due to the lack of compaction or base course binding, excessive grades, lack of crossfall, or the build-up of debris on shoulders preventing drainage of surface water. The best option to overcome scouring is cutting, grading and compacting the affected material to ensure the crossfall and superelevation is reconstructed. Cleaning out ditches and berms will ensure that water is directed away from the roadway. The use of a high-quality mechanical interlocking aggregate, and stabilisation of the pavement can also be employed.

9.5.2 Reshaping

Surface pavement maintenance normally includes reshaping the pavement cross section, light grading to remove corrugations, ruts and pot holes, moving displaced running course back onto the roadway, and some regravelling (remetalling) the pavement, if required. It will help to improve vehicle safety and road drainage.

Between a good grader operator and metal truck driver, most surface pavement issues will be addressed rapidly. A poor grader operator could compound the problems. The grading frequency will depend on the traffic volume, axle weights, materials involved and the skill of the operator.

One of the most critical aspects of unsealed roads is correct crossfall and superelevation. Ensuring this is maintained, will provide effective water runoff from the pavement. The loss of

road shape can be attributed to loss of material, settlement, poor construction or inadequate drainage, and improper grading practices. The only way to effectively reshape the road carriageway is to heavily grade the surface, reshape and then compact.

Road shoulders are part of the road cross section between the road running surface and the outside extent of the road. Shoulder maintenance will improve pavement drainage and reduce the risk of pavement edge defects. Shoulders can settle more than the pavement due to incorrect compaction at the time of construction. Vegetation and displaced road aggregate can build up on the shoulder, creating drainage issues like ponding. Also, road runoff can scour the roadside edge, because water is diverted along the roadway rather than across the shoulder into the ditch.

The best procedure to reshape and remove surface pavement defects, like corrugations and potholes, involves:

- Blading (scarifying) the surface
- Adding material. Either new metal, or metal pulled back from the edges of the road
- Mixing and shaping the surface to form a crown
- Finally, compacting at the optimum moisture content.

Maintaining the road crown or crossfall is critical. The grading should begin at the edge of the road, and work towards the centre. The cutting depth will depend on the reshaping procedure required. The windrowed material is positioned at the centre of the road, then spread evenly back across the cut surface on the final pass. This procedure is then repeated for the other side of the road carriageway. It is important that the grader does not make a final pass down the centre of the road with the blade horizontal, because this will remove the crown.

Maintaining superelevation on the curves provides effective drainage of water from the carriageway, as well as providing easier cornering for vehicles. The most important feature of superelevation is that it needs to gently transition between the corner and the



Insufficient ditch depth plus poor shoulder maintenance led to water following the road



Grader reshaping road pavement

straights. Any sudden change can adversely affect vehicle handling. Care must be taken not to create superelevation by dropping the inside edge of the road. Crossfall superelevation should not be too high for heavy vehicles – 6% is suggested as an absolute maximum.

9.5.3 Adding new running course

As a rough guide, running course should not be allowed to become less than 25 mm thick. It provides traffic with a smooth surface over which to travel, and stops it from wearing out the protective base course, which provides drainage and load distribution. A good metal truck operator will be able to effectively spread the metal along the road section to the required depth wanted.

If material removed from the running course is not replaced, the base course material will eventually be lost. This will reduce the depth of the pavement, ruts will appear due to the lack of load distribution, and the subgrade will fail under loading. Replacing gravel before subgrade failure occurs is an integral key to long lasting pavement performance.

All maintenance plans should include adding new running course material when needed. The road surface is worn away by traffic at varying rates due to:

- Weather
- Weight, speed and frequency of traffic
- Road gradient

- Tightness of curves
- Depth of the running surface
- Type of pavement material used.

In wet conditions on steep roads, heavy traffic can accelerate the wearing process causing rapid deterioration. In dry conditions, aggregate is lost through raveling and dust.

In locations subject to freezing, shaded roadways may freeze during the winter months. Roadside trees can prevent the sun from melting the ice, resulting in the road being slippery all day. This is compounded if the cold weather continues. Using a broken stone and large aggregate will cause it to protrude above the ice formation, providing a safer running surface. Also, if necessary, trees can be removed from the sides of the road to allow sun onto the pavement.

9.6 Road foundation maintenance

Foundation defects are mainly caused by the introduction of water into the pavement and subgrade, either by inadequate surface drainage or by seepage from the surrounding environment. They are generally expensive to fix but need to be rectified, otherwise ongoing problems will occur. Foundation defects include widespread subgrade failure and more localised rutting, and soft spots.

The use of lower tyre pressure in heavy vehicles has been shown to reduce the occurrence of defects in fully compacted pavements. The lower tyre pressure creates a larger footprint for the tyre, leading to less impact on the road. The use of low-pressure technology has increased but its use is dictated by the load carried and the speed of the vehicle. On forest roads, loaded trucks equipped with central tyre inflation should reduce tyre pressure.

9.6.1 Rutting, soft spot, and subgrade failure

Movement of material within the pavement causes localised soft spots. Generally, these are found in the wheel paths, but they can also occur elsewhere across the pavement surface. Soft spots are often found in material containing a high proportion of fines, which have not been

9. Road maintenance, repairs and upgrades – continued

well compacted. Another cause is the entry of water into the pavement from either the surface, or water seeping up via capillary action into the subgrade. The best way to help overcome the formation of soft spots is to dig it up and replace with correctly graded, compacted, or stabilised material. Correct compaction at optimum moisture content (OMC) of well-graded aggregate material will reduce the risk of soft spot formation. Maintaining superelevation and crossfall will ensure adequate drainage. Good roadside drainage will prevent water from ponding, and reduce the chance of water entering the pavement from the surrounding environment. In some cases, subsoil drainage may be required.



Pavement showing a soft spot

Rutting is longitudinal deformations in the wheel paths, caused by traffic. The traffic movement compacts the material directly under the wheel, creating rutting. Rutting in dry conditions occurs in non-cohesive materials such as sands or gravels, which have a low fines content. In wet conditions, rutting usually occurs in materials that are sensitive to water or have high water content.

Rutting is due to failure of the subgrade, base course or surface material. Excessive quantities of water entering the pavement or subgrade, along with excessive fines, poor compaction of pavement and inadequate pavement depth for the wheel loading contributes to rutting.



Road rutting creates a safety and maintenance issue

Surface rutting will reduce through maintaining or rehabilitating the crossfall and compacting the running surface. As with corrugations and potholes, ruts can be removed by cutting the surface to just below the rut, and reshaping and compacting the pavement. For subgrade failure, additional material is required to increase the pavement depth and, therefore, distribute the applied load. The risk of rutting is reduced if the correct pavement depth is applied at construction for the strength of the subgrade. Also, the correct material gradation will allow effective compaction and water fastness. Maintaining crossfall and optimum compaction of pavement material will also reduce the risk of rutting. Ensuring that adequate pavement depth is maintained will better distribute the load onto the weak subgrade.

Subgrade failure is usually identified by large, soft or depressed areas within the roadway. They primarily occur in the wheel paths, but can be found across the entire road pavement. The same reasons for more widespread subgrade failure apply to those described above for rutting. The only solution to subgrade failure is to remove all soft and poor-quality material. The depth of extraction should continue until a solid base is found. Backfilling with good quality aggregate will be required. It must be compacted to form a stable base, and subsurface drains may also be needed. In some situations, other options are needed, such as in poor weather conditions combined with operational requirements that demand a rapid



fix. These include using geosynthetics, log corduroy and subsurface drains. Geosynthetics and corduroy stop the mixing of pavement and subgrade materials that can cause foundation defects, and they also help to spread the applied load evenly over the soft subgrade. In situations where the road is low lying, and where water entering the pavement is a potential problem, subsurface drains in the subgrade and pavement will help to drain the affected area, reducing risk of occurrence. Subgrade failure can often be prevented. Logging on non-compacted new or 'green' roads may lead to subgrade failure. These often expensive and inconvenient failures can be prevented through having an ahead roading position or by constructing roads so that are robust enough for 'green' use. Also, the addition of aggregate material is a preventative measure, since this increases the pavement depth and the distribution of the applied loads onto the subgrade.

Shaping the subgrade material will also encourage water runoff before and during construction, and in the event of any water entering the pavement. In situations where a stable base cannot be achieved, stabilisation with lime, cement or other chemical product may be required.

9.7 Landing rehabilitation and decommissioning

This section will only discuss the engineering related rehabilitation and repairs and maintenance. For example, burning of slash will not be discussed. Refer to the Forest Practice Guide, *Managing slash on landings* for additional information.

Check new landings and pads after construction as part of a regular inspection programme. Landings are often built up to 8-12 months prior to harvesting, and post-construction repairs and maintenance may be required in more erosion prone areas especially after heavy rainfall. Most landings need post-harvest rehabilitation and decommissioning. The two critical components to manage are water control and slash. Poorly directed water can pond or undermine earthworks. The volume and weight of slash, including bark and the water it can contain, will



Top, centre, above: A landing failure reduces site productivity, and can trigger environmental effects like highly erosive debris flows. Large boom excavators increase the reach and slash that can be removed. The landing (centre) has had a normal excavator complete the rehab but significant slash remains

9. Road maintenance, repairs and upgrades – continued



Good examples of decommissioned landings

also load the landing with additional weight and reduce the shear strength of the structure.

Unstable slash should be pulled back from the landing edge with an excavator. Also remove to solid ground harvesting processor generated deposits of bark where it has formed deep, wet, heavy layers where it could increase the risk of landing failure. On steep erodible slopes, if processing slash is not contained on purpose-built slash benches, it should be reduced to a level where the ground is visible through the remaining material. Install drainage and sediment control structures to improve water control and fill stability. For example, minimise the entry of stormwater into birds' nests. Removing slash from risk prone locations can be extremely challenging to do, and in some cases is not possible. Placing the slash in the right place during harvesting not only saves costs but also eliminates or reduces a problem.

The details behind maintenance of erosion and sediment control structures are described in section 9.9.

9.8 Roadside vegetation maintenance

Controlling and maintaining roadside vegetation can reduce maintenance, and significantly improve driver safety. It improves sight distances around corners, and approaching bridges and intersections, and creates a wider road for passing traffic. Design sight distances must be

maintained over the period of operational use of the road. This is a requirement of WorkSafe's *Approved Code of Practice for Safety and Health in Forest Operations*.

Overgrown vegetation tends to shade the road, especially during winter. This increases the risk of pavement damage, because it prevents the road surface from drying, and will increase ice in areas prone to freezing. Also, road obstructions, such as fallen trees and overhanging branches, will hinder access, create a safety risk, and cause drainage structure damage as vehicles move off the running surface to avoid the vegetation.

Too much vegetation in ditches will reduce water flow, and possibly create dams and washouts, or other maintenance problems. For example, culverts and ditches can be damaged because machinery operators cannot see the culvert ends because of vegetation growing in them.

Ditches can be mowed or sprayed. Most roadside vegetation maintenance needs to be completed during spring and summer, because this is when vegetation grows fastest. However, care should be taken not to eliminate all vegetation from the ditch, or scouring could result. Be careful of fire risk. Mowing can create fires due to sparks from stones and mower blades. Dried vegetation can increase the roadside fire risk.

If the roadside scrub gets too large, it can be a



challenge to remove it efficiently. Roadside flails or mowers can generally cut material below 100 mm in diameter, so maintenance should be completed before vegetation reaches this stage.

9.9 Erosion and sediment control structure maintenance

Erosion and sediment control structure maintenance covers ditches, cut-outs, berms, drainage culverts, flumes, silt traps and soak holes, silt fences and sediment ponds. Erosion and sediment control structures need regular maintenance. Prepare a routine maintenance plan which includes heavy rainfall response measures. Check these as part of any heavy rain or post-storm road maintenance assessment.

The most challenging time for maintenance is often after new construction and the first heavy rain, and before vegetative cover establishes. Ensure erosion and sediment control maintenance is planned and meets their intended purposes. For example, ensure there are enough road drainage culverts and cut-outs to control stormwater runoff. If not, either construct additional ones, build rock armour, check dams, or apply polymers in areas that ditch to highly sensitive receiving areas.

9.9.1 Ditches

Maintain ditches. They can require regular maintenance due to cut bank slumping, which can disrupt their drainage pathway. Ditch damage is the primary reason for blocked culverts, as these can get blocked with sediment and debris. Where ditches have ongoing siltation issues, the best solution may be to address the problem at its source. If this cannot be resolved, then other erosion control methods may be useful, including armouring the ditch or putting in check dams. Associated structure, such as grassing or hydroseeding, or establishing sediment traps close to the source, may be needed to reduce sedimentation. Some vegetation like grass, but not dense, in the ditch may be useful for reducing water speed and scouring.

Ditches can be cleared by front-end loader, excavator, grader or by hand. The choice is likely to depend on the condition of the ditch, and the amount of maintenance work, its type and



Check ditches for scour. Poor water control maintenance, along with heavy rain and a steep road section, created this bad mix of environmental, health and safety, and infrastructure risk in pumice country

depth. The use of excavators will prevent fine material being spread on the roadway, which can create a road surface problem. This is a problem when a grader is used in these materials.

Care must be taken not to cut too much material from the ditch bank's toe and bed; this can cause additional ongoing bank collapse or erosion.

9. Road maintenance, repairs and upgrades – continued



Left: Ditches initially need regular maintenance, especially where cut bank collapse is a common and unwanted aspect in some soil and geology types. Right: Poor ditch maintenance caused a scour across this road

9.9.2 Cut-outs and berms

Berms control water flow along the outer edge of the road to cut-outs, which direct it off. It is essential that berms maintain this function. Maintenance should focus on removal of debris that blocks or diverts water, so that water can

freely flow along them. Cut-out maintenance can be done with an excavator, or if the road allows, with the grader as part of a grading programme. If there has been berm edge collapse, or if machinery has been driven/sited on the berm, then the structure needs to be shored up as soon as practicable. There is a temptation when

doing roading maintenance to dump spoil, such as road bank slump material, on top of an existing berm. This can overload the berm's outside edge and cause fill failure. Where practicable, avoid spraying vegetation on the berm when pre-plant desiccation spraying.

Regular inspection of the berms should be done to identify any areas which may have been damaged by vehicles.



Left: Berm cut-outs can be vulnerable to storm damage because they are compacted fill. Consider armouring, especially when they link to other structures over a fill face, like a culvert sock



9.9.3 Drainage culverts

Cleaning out drainage culverts is a core maintenance task. This includes keeping culverts clean and free of debris, and repairing any damaged or broken culvert entrances or outlets. On new construction, inlets can easily block. It is essential that culvert spacing is sufficient to adequately drain the stormwater runoff. If not, install additional drainage culverts.

If the drainage culverts are installed correctly, then maintenance can easily be done by an excavator. If the entrance is too tight for an excavator bucket, then they will need to be cleared by hand. Blocked drainage culverts require water blasting out. A good way of doing this is using a forest fire appliance and spraying from the outlet back.



Drainage culvert mouths can easily block. Without maintenance, these culverts will likely block, and be bypassed in heavy rain. Left: Wind, not water, deposited debris has nearly blocked this culvert. Right: Bank collapse and sediment infill is a common issue



Check for crushed drainage culverts after logging. Drainage culverts are easily damaged if the maintenance operator is inattentive

9. Road maintenance, repairs and upgrades – continued



Remove slash and harvest debris from flumes. Damaged or poorly installed flumes can lead to major fill slope erosion

9.9.4 Flumes

Flumes should be kept clear of debris to allow the water to flow freely. Any broken or worn sections of a flume should be replaced. The flume should be kept as watertight as possible to prevent batter slope erosion. Flume pegs should also be inspected, and any damaged ones replaced.

Flumes need regular maintenance, especially on a new construction. Check flumes for functionality after a heavy rain event, and ensure that they have enough capacity to control stormwater runoff. If not, add additional controls as part of maintenance.

9.9.5 Sediment traps, soak holes, sediment fences and retention ponds

Sediment traps and soak holes need regular maintenance, especially with new construction and after a heavy rain event, as water can transport significant amounts of sediment and fill them in. To maintain their effectiveness, they need to be cleaned out. Check that the spacing of sediment traps and soak holes is enough to manage the stormwater runoff. It may be useful to monitor the quantity of material removed to identify problem areas. Place the sediment where it cannot wash back into the structure or create another sediment issue. Where culverts are present, take care not to damage the drainage



During repairs and maintenance, make sure that culvert socks are adequately secured to the culvert, and pegged so they will not twist and block



This soak hole does not have an exit, so once full of water and/or sediment it diverts back onto the road. Better location and maintenance could fix this problem



This fence needs maintenance. Sediment is spilling around the sides of the structure

culvert inlet or outlet when cleaning them out. Dig the fines out of soak holes, as they may lose their effectiveness if fine material seals the floor of the soak hole, and inhibits drainage.

Silt fences need regular maintenance because they can fill rapidly on very erodible soil sites. Check silt fences regularly, and after any moderate rainfall, especially on new construction sites. Another important aspect is to check that the silt fence is working correctly, and is sized to the site. If not, enlarge if possible, or redirect some of the flow to another stormwater control measure. When cleaning the fence, remove



This pond has filled, then the wall has become saturated, and finally the water has sluiced through it

sediment to a safe location where it cannot wash back into the fence, enter a sensitive area or be subject to further erosion.

Check sediment ponds for structural integrity and capacity as part of any heavy rain or post-storm event road maintenance assessment. They need regular maintenance, especially on new construction. Also check that the structure is appropriately sized with a sufficient safety factor to control the stormwater runoff. Alternatively, re-direct some of the flow to another stormwater control measure.

Cleaning is usually done by an excavator or backhoe for these structures.

9.10 River crossing maintenance

This section will split river crossing maintenance into three groups – instream and permanent, instream and temporary, and single span bridges.

For all structures, prepare a routine maintenance plan which includes heavy rainfall response measures. Heavy rain and especially storms are likely to trigger maintenance. The main causes for maintenance are woody debris and scouring of inlets, outlets and abutments.

Check all new structures after heavy rain and flood flows. Instream structures often initially require regular maintenance. Fix any issues promptly. Take care cleaning sediment and woody debris around river crossings. In some situations, consider removing debris by hand rather than using heavy equipment, which can easily damage structures like culvert inlets.

The NES-PF has many regulations for river crossings that include maintenance. It is essential to understand these before starting maintenance. Consents may be required.

Consider fish passage retrofits, if necessary. Design and construction practices for fish passage through crossings has been discussed in Chapter 8: River crossings. This includes retrofitting options for non-fish accessible structures.

If there has been damage to a crossing's structural integrity, seek professional expertise to fix it if there is no in-house expertise, or regulations require mitigation works to be signed off by an engineer.

9. Road maintenance, repairs and upgrades – continued



Left: Routine woody debris removal from a culvert inlet. Right: This unacceptable construction job has led to a major repair and maintenance problem. Uncompacted fill and poor inlet armouring will lead to unnecessary maintenance, NES-PF non-compliance and environmental risks

9.10.1 Culverts, battery culverts, drift decks and fords

Check all instream structures for scouring around the inlets, batters and outlets, especially in culverts. This is due to water being forced to flow through a reduced opening. With the other structures, flood flows are designed to overtop the structures. With these, they can still scour or block as flow velocity still increases around the pipe edges as water is forced into the opening. The main cause of scour is damage caused by debris. Wing walls,

aprons, cut-off walls and embankment paving can prevent scouring. If a structure has ongoing debris maintenance problems, consider constructing a debris control structure upstream to help prevent debris from even entering the culvert, battery culvert or drift deck.

Maintenance of structures typically includes:

- Removal of debris around and in the structure
- Re-enforcing the structures where there has been damage. For example, adding rock rip rap immediately downstream



A rusted-through steel culvert floor and a concrete pipe's floor worn past its steel reinforcing



This battery culvert was well constructed, and had relatively minor repairs and maintenance considering the storm flow was 1.5 m above the structure. Left: The reno mattress has protected the crossing from undermining. Note that the gravel movement from the storm has blocked all but one of the pipes. Right: Weaknesses have been armoured. The holes are used to pump grout in and fill the void. Armour known weaknesses

- Maintenance of the approaching road grades, to eliminate water drainage along the road carriageway.

Culvert pipe inverts, the base of the pipe, and headwall and/or outlets wear out over time through debris and bed load abrasion or from water chemistry, especially corrugated steel. Concrete will have signs of cracking and rust protruding from reinforcing steel. Galvanised steel culverts may have severe rust, especially along joins, or the bottoms may have rotted or worn out. They should be repaired promptly to prevent further corrosion or structure collapse. Replacement may also be required. This often requires specialist engineering assistance. Culvert structural maintenance is beyond the scope of this Manual.

Check ford crossings after heavy rain or a flood flow event. Fords can create serious safety issues if the river bed has shifted, or there is river bed erosion affecting the ford's concrete structure. Natural bed crossings are likely to need maintenance after most flood events, as riverbeds regularly change. This may include grading of the running surface, and addition of replacement of material, where necessary. Maintenance of fords must be completed with extreme care to minimise environmental effects especially when working with concrete or a river with a fine sediment substrate.



Prompt post-storm maintenance is essential for this structure

9.10.2 Temporary river crossing maintenance and removal

River crossings provide road access to a harvesting site, or give access for harvesting equipment where log extraction requires the need to temporarily cross a river. The maintenance of a temporary bridge is the same as that required for a permanent one, see 9.10.3 Single span bridges.

Poorly planned, constructed or maintained

9. Road maintenance, repairs and upgrades – continued

temporary harvest extraction river crossings provide one of the greatest opportunities for sediment delivery to water. They are also widely and regularly used by ground-based harvest machinery to extract felled trees. It is essential that temporary crossings are proactively managed, because river crossings can be difficult to maintain in wet periods, and the release of sediment at these times can be large if not managed well. Fix problems when they start to show rather than letting them turn into bigger ones. For example, approach tracks can rut out, so sediment can bypass control structures like cut-outs and directly enter the waterway. Getting machinery to try and fix the problem in poor conditions can lead to making the problem worse. Maintenance includes the following:

1. Maintain the integrity of log crossings
2. Maintain river crossings and approaches so that stormwater control is effective
3. Ensure culverts are not getting blocked with woody debris from the harvest operation
4. During wet weather, limit the use of the crossing to minimise mud accumulating on the track leading into and away from the crossing
5. Stop operations when the approach tracks or the crossing are releasing sediment to the river, and divert any track stormwater onto the cut-over.

Ensure temporary crossings are removed. It is a NES-PF rule to remove the material used to construct the crossing within one week of finishing the operation. This can be done by the harvesting contractor, if they have suitable machinery like an excavator, immediately prior to shifting blocks. Otherwise, bring in suitable machinery to complete the work.

Crossing material should be placed in a location that minimises the risk of it entering the river; it needs to be shifted above the flood level. Make sure that additional logging slash built up due to using the crossing is also removed. Also, ensure that the approaches are rehabilitated or decommissioned to eliminate future sources of track sediment.

All material used to construct the instream crossing must be removed within one week of finishing the logging operation.

9.10.3 Single span bridges

Bridges need regular inspection and maintenance, depending on the type, age and level of use.

It is recommended that permanent bridges have a regular two-year engineering inspection programme. WorkSafe's *Approved Code of Practice for Safety and Health in Forest Operations* requires that 'A bridge inspection programme shall be designed by a suitably experienced Chartered Professional Engineer'. Temporary bridges are structures that will not be in place for more than two years, but they should be inspected to make sure they continue to be fit for purpose.

The assessment should cover the condition of the material of each component, and how well each component is performing. This includes reviewing the condition of the bank protection measures, abutments, piers, bearers, beams, bracing, decking kerbs, rails and delineators, and signs. Repairs or replacement should be done where damaged or decayed members are located. If deterioration is severe, it may be necessary to limit the maximum vehicle weight on the bridge until repairs have been carried out.

It is good practice, when inspecting bridges, to have all previous information, such as photos, maps and previous inspection reports, at hand. It is also recommended that each inspection should take a minimum of 10 key photos so that they will form the maintenance record:

- Two photos of the elevation (side) view of the bridge, from upstream and downstream
- Two photos of the bridge deck and road surface, in both directions of travel
- Two photos of the underside of the bridge, taken from both ends of the bridge
- Four photos of the road embankment, adjacent to the abutments or wing walls

Refer *Field Guide for Inspecting Bridges* (FP innovations, 2011).

The specific maintenance will come out of the inspection. This could include stabilising bridge approaches to reduce rutting, cleaning bridge decks of gravel and debris, and fixing damaged rails. WorkSafe's *Approved Code of Practice for Safety and Health in Forest Operations* requires all bridges with a load carrying capacity of less



Regularly inspect the condition of bridge components

than Class 1 (7.1 tonne per axle) shall have their capacity signposted.

Many older bridges have lead-based paint. Always get professional advice and contact the regional council to make sure that removing old paint meets regulation. Sometimes a river channel may be subject to erosion next to and/or underneath an abutment. It may then be necessary to carry out river channel remedial work. Again, make sure you are familiar with the regulations including the NES-PF.

implications for the forest owner or manager. Always maintain the debris trap to a maximum of two thirds storage capacity.

There are specific requirements within the NES-PF concerning maintenance, and subsequent reporting. It is important that these are incorporated into the maintenance plan. Subscribe to Te Uru Rākau's updates of the regulations to keep informed of changes. The regulations require debris traps to avoid erosion of the river bed, and that they be maintained in a structurally sound and effective condition. The regulations also have these additional maintenance and reporting rules:

1. Debris traps need to be visited within five working days after a storm event that could have mobilised slash (5% AEP or greater)
2. Debris traps need to be cleared of debris within 20 working days after a storm event
3. Cleared debris needs to be put beyond the flood plain, or beyond where it could be mobilised by a flood event up to a 1-in-20-year event (5% AEP)
4. Something that could easily be overlooked is that the NES-PF regulations also require a written report to the regional council by 31 March each year that includes:
 - a. Frequency of maintenance and clearing.
 - b. Debris trap condition and performance.
 - c. Any damage to downstream property, river bed disturbance, fish passage blockages.



Maintain bridge signage

9.11 Debris trap maintenance

Debris traps must be part of a regular maintenance plan which includes heavy rainfall response measures. Some debris traps are designed to contain large amounts of mobilised debris after heavy rain, so they need to be carefully monitored. Poor maintenance could lead to woody debris being moved off-site and have social, environmental and regulatory



This highly effective debris trap needs to be cleaned to continue to limit slash from going off-site. Know the NES-PF regulations around debris trap maintenance and reporting

Forest road engineering terminology

A

Abney level: A handheld clinometer used to measure a slope.

Adverse grade: The uphill grade in the direction that a loaded truck would travel. Conversely, favourable grade refers to the uphill grade that an unloaded truck would travel.

AEP: Annual exceedance probability. The chance of a flood of a given size (or larger) occurring in any one year. Usually expressed as a percentage.

Aggregate: Material formed from a mass of fragments or particles loosely compacted together, or mechanically crushed, angular rock used for forest road surfacing.

Angle of repose: The angle between the horizontal and the maximum slope that soil assumes through natural processes. It generally applies to dry granular soils.

Apron: A hard (generally concrete) surface layer constructed at the entrance or outlet of a river crossing structure. Can be augmented with rocks to improve fish passage.

Arterial road: The main road in a forest to which multiple secondary roads will connect.

Assessment of effects: A process of systematically identifying the effects of a proposed activity or activities on the environment.

Auger: A helical (spiral) shaped drill used to bore holes into the ground for the purpose of obtaining soil samples.

B

Backfill: Soil or other material used to replace material removed during construction.

Balanced road section: An excavation technique used on gentle to moderate slopes where the excavated cut material is used to make the adjacent fill on a section of road. On a balanced road section, the cut material is equal to the compacted fill material.

Bankfull channel width: The distance across a river channel, formed by the dominant channel-forming flow, with a recurrence interval seldom outside a 1 to 2-year range (measured at a right angle to the channel flow).

Base course: The bottom layer of road surface rock in a two-layer surfacing system. The base course is the layer between the subgrade and the surface (running) layer of crushed rock.

Batters: Constructed slopes of uniform gradient.

Battery culvert: A river crossing structure made by using multiple culverts that allow the free flow of water through the culverts in low flow conditions, and water and debris to flow over the top of the entire structure in high flow.

Bearing strength: The amount of weight that a soil or subgrade can safely support without plastic (permanent) deformation.

Bed invert gradient: The waterway bed slope where the rise or fall of the horizontal distance of a river channel is measured in metres.

Bedrock: The continuous body of rock, of a relatively great thickness, that underlies the overburden soils.

Bench: A ledge cut to contain fill, or a step cut into a batter to make it more stable.

Benchmark: A term used in surveying to infer a reference point. For example, to signify a starting point.

Berm: A raised or engineered structure parallel to the edge of the road or track, designed to contain and direct surface water runoff and sediment.

Birds nest: a. A wire rope that has over-spoiled from a drum to the point where it is tangled; b. Logging residues stacked on, or over, the edge of a landing.

Borrow: Any excavation from outside the construction batter limits shown on the drawings.

Borrow pit: An area smaller than a quarry where material has been dug out.

Broad-based dip: A shallow depression dug across a road to facilitate road surface drainage without interrupting vehicle passage.

Brush cut: To clear away brush from a trail, survey line, or tree before working.

Bulk fill: Material placed in the form of fill, from the ground surface after clearing and removing of top soil.

Bunding: A secondary containment system to contain and prevent leakage around an operation or storage facility.

Camber: The gradual downward slope from the centre of a crowned road.

Catch point: The point at which a road cut or fill slope intercepts the natural ground.

Catchment: An area where water is collected by the natural landscape. Gravity causes all rain and runoff in the catchment to run downhill where it naturally collects in creeks, rivers, lakes or the sea. Also referred to as a watershed or drainage basin.

Centreline: The centre of a planned or established road.

Clay: Soil finer than 0.002 mm that exhibits plasticity with a range of water contents. It usually exhibits considerable strength, depending on the presence of other soil materials when air-dried.

Clearing: An area within a roadway clearing limit where standing and dead vegetation have been removed. This is the first step of construction on a forest road.

Cobble: Rock fragments, usually rounded, with an average diameter of 75-300 mm.

Compaction: The process of applying pressure or vibration to soil or aggregate to strengthen it, resulting in increased density (tonnes per m³).

C



Cold deck: A pile or deck of logs stored for some time between phases of the operation. For example, processing and loading, or skidding and processing.

Cone Penetration Test (CPT): An in-situ test for determining soil properties. It consists of slowly pressing a steel cone into the soil to measure the penetration resistance.

Corduroy road: A structured load-bearing surface where logs are laid horizontally and parallel, with no void areas. Corduroy roads are an engineered road construction technique used in places where the substrate is very weak, and where the load must be spread if the road is to be trafficable. This can be used on skid trails or landings, or with adequate surfacing also on haul roads.

Crest vertical curve: The transition between an uphill and downhill grade, an uphill to less extreme uphill grade, or a downhill to a less extreme downhill grade.

Crowned: A road surface that is sloped from the centre of the road to the inside and outside road edges to achieve road surface drainage.

Cross-ditch: A shallow channel excavated or bladed diagonally across the surface of a road (or skid trail), to lead water off the road and prevent soil erosion. On smaller skid trails they are also referred to as water bars.

Cross-drain culvert: A pipe that carries water from road ditches and discharges on the downhill side.

Crossfall: The cross slope for roads that are not crowned.

Crushed rock: Angular rock used for road surfacing. Often mechanically crushed to a specified range of rock particle sizes.

Culvert: a. A pipe or box structure that conveys a stormwater flow under a forestry road or forestry track; b. The entire structure used to channel a water body under a forestry road or forestry track.

Cut: An excavation within the construction batter limits shown on the drawings and above the final subgrade surface. The cut includes side cuts and batters.

Cut-off or cut-out: Shallow channels or earth mounds constructed across a road, track or firebreak to divert and control runoff. Cut-offs are constructed to minimise sediment movement and scouring by preventing the accumulation of sufficient flow and velocity to support erosion. Unlike water bars, cut-offs are normally used in impermeable soils and are not used for retaining runoff.

Cut slope: The inside road slope cut into the face of the hill slope.

Daylighting: The process of removing trees to allow sunlight to dry out a roadway or landing.

Debris trap: A structure designed to catch and temporarily store harvest residues from flowing water. Also known as a slash trap or woody debris trap.

Degree of saturation: The degree to which the voids in a soil mass contain fluid. Usually expressed as the ratio of water volume to total void volume.

Dilatancy: The phenomenon of expansion of cohesionless soils when subjected to shearing deformation.

Ditch: An engineered channel, often dug at the toe of a fill batter, running parallel to the edge of a road surface. It is designed to catch stormwater runoff from the road surface and carry it to suitably located and constructed discharge points. Often incorrectly called a water table, water table drain, drain or roadside drain.

Drainage (stormwater) culvert: The culvert below the road profile that cross-drains water from the roadside drain at the inner edge of a forestry road or forestry track to its outer edge.

Duff: Accumulated surface litter on the forest floor.

Earthworks: As defined by the NES-PF: a. A disturbance of the surface of the land by the movement, deposition, or removal of earth (or any other matter constituting the land, such as soil, clay, sand, or rock) in relation to plantation forestry; b. Includes the construction of forestry roads, forestry tracks, landings and river crossing approaches, cut and fill operations, maintenance and upgrade of existing earthworks, and forestry road widening and realignment; c. Does not include soil disturbance by machinery passes, forestry quarrying, or mechanical land preparation.

Ecosystem: The complex ecological community and environment forming a functional whole in nature.

Embankment: Soil, aggregate or rock material placed on a prepared ground surface and constructed to grade. The embankment is the fill material on the downhill side of the road, or, on fill sections, the entire road.

End haul: Moving excavated roadway material a distance (usually by dump truck) to a designated soil dump site. Often used with full bench construction instead of side-casting the cut directly onto the slope.

Energy dissipater: A structure, usually made of rock or logs, that dissipates the energy of water discharged from a culvert. If constructed from large angular rock it is referred to as 'rip rap'.

Ephemeral river flows: Water flow in a river or stream that only occurs during and immediately after rain.

Erosion: The process of dislodging and transporting soil particles by wind, flowing water or rain.

E

D

Forest road engineering terminology – continued

F

Erosion susceptibility classification: A system within the NES-PF that determines the risk of erosion on land across New Zealand, based on environmental characteristics. These include rock type and slope. Land is classified into four categories of erosion susceptibility according to the level of risk: Low (green), moderate (yellow), high (orange), and very high (red).

Excavation: Removing earth from an area.

Fifty-year flood: A flood event that has a 2% probability of occurring annually. The scale of this projected flood will determine the dimensions of several components of roads built around rivers, such as bridges and culverts.

Fill: Soil or aggregate, placed to raise the land surface, normally under a strict compaction regime. It can be used to build a structure above natural ground level, as with fill sections on the downhill side of a road.

Fill slope: An area on the downhill side of a roadway (or both sides in a through fill section) that must have excavated material placed on them to build a road section up to grade.

Filter (or buffer) strip: Land adjacent to a water body; its vegetative cover is used to filter the sediments out of surface runoff water from cutover or roads.

Flagging: Coloured plastic ribbons, which can be attached to trees or stakes to make boundaries, stakes and other markers visible.

Flume, or fluming: An open channel or conduit, made from plastic, galvanised corrugated steel, and sometimes concrete, or timber, which is used to carry runoff from earthworks over loose fill or erodible material so that it can be discharged onto less erodible surfaces.

Ford: A hard surface on the bed of a river, permanently or frequently overtopped by water, that allows the crossing of a river by machinery or vehicles.

Fording: The act of driving across the bed of a river.

Forest infrastructure: Structures and facilities that are required for the operation of the forest. These include roads, forestry tracks, river crossings, landings, fire breaks, stormwater and sediment control structures, and water runoff controls.

Forest road: A road designed for forest activities. Requirements may change over a rotation because the width, grade, strength and pavement surface will be different for general forestry activities than for a road that allows a fully laden logging truck to safely traverse it, and that has all-weather access. The term forest road does not include roads managed by a local authority.

Forest track: As defined by the NES-PF, a track that allows the passage of forestry machinery or vehicles, but does not provide the width, grade, strength, or pavement surface to allow a fully laden logging truck to safely traverse it. It may also lack all-weather access.

Frost heave: The heaving of the ground due to the formation of ice lenses.

Gabion: A cage, cylinder or box filled with rocks, concrete, or sand and soil for use in civil engineering and road building.

Geotextiles: Synthetic fabrics designed for use in soil stabilisation and control.

Grade (slope): The tangent of the angle from the land surface to the horizontal. Grades are typically specified for new road constructions.

Gradation: The graph showing the proportions by mass of a soil or fragmented rock distributed in specified particle-size ranges.

Granular fill material: Material which has been placed in the fill, and which contains less than 35% passing a 60µm sieve (fines = silts and clays).

Gravel: Particles of rock between 5-75 mm in size. They can be rounded, semi-rounded or angular.

Green strip: An uncut strip of timber left along rivers and roads. Also known as buffer strip, leave strip, or streamside management zone.

Grubbing: Digging and removing stumps, roots and duff within the clearing limits of the roadway.

Grizzly: A rock screen device often used during gravel extraction or at a rock truck loading area.

Heading up: A hydraulic head of water above the culvert inlet that occurs when the nominal capacity of the culvert is exceeded.

Headwall: A wall built at the upstream end of a culvert.

Heave: The expansion or displacement of soil caused by phenomena such as moisture absorption, removal of pressure, driving of piles, frost action, and/or loading of an adjacent area.

Highway truck: A truck designed to haul a load that does not exceed legal highway limits.

Horizontal curve: A circular curve used to change the horizontal direction of a road.

Hot deck: A landing where the processing of stems to logs is done in conjunction with the loading out activity.

Hydro-seeding: A seed mulch and water mix sprayed onto fills and batters

In-situ: The in-place or undisturbed properties or state of a soil.

In-slope: A road surface sloped toward the ditched side, or the inside shoulder, of a road.

Intermittent river: A river that does not flow year-round. It is commonly dry three or more months per year.

Landing (pad, skid): An area of land where logs or tree lengths extracted from a forest are accumulated, processed, and loaded for removal.

G

H

I

L



Landslide: The downward and outward sliding or movement of a mass of earth or rock, or a mixture of both. Also referred to as mass wasting.

Lift: A layer of soil or road surface rock.

Loam: A mixture of sand, silt, or clay, or a combination of any of these, with organic matter.

Loess: A uniform aeolian (relating to or arising from the action of the wind) deposit of silty material. It has an open structure and relatively high cohesion due to cementation of grains. A characteristic of loess deposits is that they can stand with nearly vertical slopes.

M

Maintenance (upgrade): As defined by the NES-PF, it includes activities that reshape and upgrade existing forestry infrastructure, the installation and maintenance of water runoff control measures, and/or road metalling. It does not include road widening or realignment.

Main road: A road that supports a high level of traffic, usually well built and well designed. They can also be referred to as primary or arterial roads

Moisture content (MC): The moisture content of soil, normally reported as the weight of water relative to the weight of soil in percent. If it is reported relative to the volume of water, it is called the volumetric MC.

Meandering line: The survey line at the high-water mark on navigable lakes and rivers.

Mud: The mixture of soil and water in a fluid state.

Mulch: A covering of loose organic material applied over the soil surface to protect it.

N

Normally consolidated soil: A soil that has never been subjected to an effective pressure greater than the existing effective overburden pressure.

O

Off-highway trucks: Trucks designed to handle loads exceeding legal highway size and weight restrictions. These trucks are not driven on highways but are used in logging operations conducted on private roads.

Off-tracking: The different paths that the front and rear wheels on a logging truck, tractor-trailer, or other vehicle take when cornering. The rear or trailer wheels take a shorter path than the front wheels around the curve, corner or turn, so the driver has to compensate for this by taking the curve, corner or turn wider. Because of off-tracking, curves will need to be wider than segments of road.

Optimum moisture content (OMC): The water content at which a soil can be compacted to a maximum dry unit weight using a specific compaction effort.

Organic soil: Soil with a high organic content, normally greater than 25% by weight. In general, organic soils are highly compressible and have poor load-sustaining properties.

Outslope: A road surface sloped to the outside shoulder. In general, an outsloped road needs no ditch because the slope of the road itself sheds runoff water away from the road.

Overburden: The overlying soil and rock that is excavated and removed to allow construction of the underlying material.

Perennial river: A river that is a continually or intermittently flowing body of freshwater, in which the intermittent flows provide habitats for the continuation of the aquatic ecosystem.

P

Penetrometer: A device used for indirectly testing the load-carrying capacity of soil by measuring its resistance to an object being forced into the soil with a standard force.

Percolation: The movement, under hydrostatic pressure, of water through soil or rock, excluding movement through large openings such as solution channels.

Plan and profile drawings: Drawings that show both horizontal (plan) and vertical (profile) delineation of a road survey or geometric design.

Pioneer road: A temporary access roadway constructed within the clearing limits to provide for clearing, grubbing, and timber removal activities.

Primary logging road: A road designed and maintained for a high level of use. Typically an all-weather gravel road that is part of a permanent road system.

Porosity: The ratio of volume of voids in a rock or soil to its total volume.

Proctor curve: The relationship between dry unit weight and water content of a soil for a given compaction effort.

Quarry: A large deep pit where rock is blasted, ripped or excavated and extracted.

Q

Ravelling: The movement of soil or aggregate, usually caused by erosion on cut and fill slopes.

R

Reconstruction: The rebuilding of existing roads, beyond normal maintenance activities.

Relief culvert: A secondary pipe that carries water during high flow event after the primary culvert has reached capacity.

Reno mattress: A double twisted hexagonal woven galvanized steel wire mesh compartmented basket with a rectangular mattress shape. Even distribution of the stone fill ensures that the reno mattress maintains intimate contact with the foundation soil.

Rill: A shallow channel cut into soil by the erosive action of flowing water.

Riparian zone: The margin and bank of a water body, including the area where direct interaction occurs between land and water systems, that is important for the management of water quality and ecological values.

Forest road engineering terminology – continued

River: As defined by the NES-PF, a river is a continually or intermittently flowing body of fresh water. It includes streams and modified watercourses, but does not include artificial watercourses such as irrigation canals, water supply races, canals for the supply of water for electricity power generation, or farm drainage canals.

River crossing: As defined by the NES-PF, a river crossing is a structure required for the operation of a plantation forest. It provides for vehicles or machinery to cross over a water body. It includes an apron and other structures and materials necessary to complete a river crossing. It does not include a stormwater culvert or a culvert under a forestry road or forestry track.

Rip rap: Large dimension (usually) loose stone used to form a foundation for a breakwater or other structure.

Road: a. A skid road in skidder or high-lead logging; b. A cleared path along which logs are hauled to the landing with one setting of the rigging; c. An access and haul route for vehicles.

Road pattern: A characteristic arrangement of spur roads in relation to each other.

Road grade: The slope of a road surface in the direction of travel, usually expressed in percent (in metres per 100 metres). For example, a 10% grade equals a change along the road of 10 metres vertical in 100 metres horizontal.

Road prism: The road geometry between the extreme points of excavation and/or fill, or between the top of the cut and the bottom of the fill.

Road template: Used to establish the shape and basic dimensions of the cross section of a road.

Roadbed: The road subgrade surface between the subgrade shoulders.

Roadway: The portion of a road within the limits of excavation and embankment.

Rock: Any igneous, sedimentary or metamorphic stone which is solidly bonded or cemented together, and which occurs in masses, ledges, seams or layers.

S

Sag vertical curve: The transition between a downhill and an uphill grade, or a steeper downhill and less severe downhill grade.

Scarification: a. A shallow loosening of the soil; b. The gravelling of a road surface.

Seasonal road: Used mainly during a specific season, such as a logging road used only during the dry season.

Secondary logging road: Designed for relatively little use. Typically, a dirt road with no gravel, used only during dry weather.

Sediment: Solid material that is: a. A mineral, or mineral and organic; b. In suspension, being transported, or has been moved from the site of origin by air, water, gravity, or ice and has come to rest on the earth's surface, either above or below water.

Sediment control measures: Structures or measures to slow or stop water with sediment in it, so that the sediment drops out of suspension before the water from the site reaches a water body.

Sheep-foot roller: A steel drum roller with protruding metal plates ('feet') used for compacting clay soils.

Side cast: Non-compacted fill or spoil that has been excavated from a cut to create forestry infrastructure on the downhill slope from the infrastructure.

Sieve analysis: A series of sieves used to determine the particle size distribution of a soil.

Slash: Woody material or debris left behind after plantation forestry activities.

Soffit: The lowest part of the span of a bridge.

Spoil: The by-product of excavations and earthworks.

Subgrade: The native material underneath a constructed road or the finished surface prior to applying the improvement layer. Also called the formation layer.

Subsoil: The layer of soil with low organic matter content found at depths of 25 cm or more below the surface of the ground. Its colour varies from brown, yellow-brown, red and olive. It contains speckled colour patterns where poorly drained.

Skid road: A road cut through the woods for skidding.

Skid trail: A skidder path through the forest.

Slip: a. Material dislodged by the force of nature from outside the cut batter limits or from the fill slope shown on the drawings; b. Relative movement in the direction of travel at the mutual contact surface of the traction or transport device and the surface that supports it.

Slope ratio: The steepness of a slope expressed as a ratio of its horizontal to vertical distance ratio. For example, a 1:1 slope changes 1 metre horizontal to every 1 metre vertical (45 degrees).

Slope stability: The resistance of a natural or artificial slope to movement or failure.

Slough: Material that has eroded and ravelled from cut or fill slopes.

Slump: A failure of a natural or constructed slope.



Soil: The upper layer of earth in which plants grow. A black or dark brown material typically consisting of a mixture of organic remains, clay, and rock particles. Often thought of as anything that is not rock.

Soil adhesion: Soil sticking to foreign materials such as soil implements, tracks, or wheels.

Soil compaction: a. Increased soil density resulting from the packing effect of machines moving over the soil; b. Disturbs soil structure and can cause decreased tree growth, increased water runoff, and soil erosion.

Soil failure: The alteration or destruction of the soil structure by mechanical forces such as in shearing, compression, or tearing.

Spur road: Supports a low level of traffic, such as a level that would serve one or two landings.

Stabilisation: a. Seeding; b. Vegetative cover, mulch, or slash cover; c. Compacting, draining, roughening, or armouring by the placement of rock or the use of other rigid materials.

Stream morphology: Refers to shapes of river channels and how they change in shape and direction over time.

Stormwater control measures: Structures or measures to manage stormwater on formed surfaces; primarily to reduce the volume or velocity of water runoff so as to reduce its power to entrain sediment.

Stumping: The removal/excavation of tree stumps from the ground, usually associated with the construction of infrastructure.

Subgrade: The layers of roadbed on which the base or surface course are placed. On an unsurfaced road, the finished subgrade is the wearing surface. That is, the top layer of a road surface.

Surface course: The top layer of a road surface, also referred to as the 'running surface'.

T

Tangent: A straight segment of road between two horizontal curves.

Temporary river crossing: A river crossing that is in place for up to two months. It includes a corduroy, which is a structure made by laying a culvert in the bed of a river to carry the water flow, creating a running surface approach using logs placed parallel to the culvert. It does not include a bridge or ford.

Temporary bridge: A single-span bridge that is in place for up to two years.

Through cut: A roadway section cut through a ridge; it will have cut slopes above both sides of the road.

Through fill: An elevated roadway section with fill slopes below both sides of the road.

Time of concentration: A concept used in hydrology to measure the response of a watershed to a rain event. It is defined as the time needed for water to flow from the most remote point in a watershed to the watershed outlet. It is a function of the topography, geology, and land use within the watershed.

TM61 method: An empirical method for estimating a design flood peak discharge in an ungauged New Zealand catchment.

Topo (Topographic map): A map that shows the elevation contours of the ground.

Topsoil: The layer of material immediately below the ground surface. It includes vegetation, turf and humus or other organic matter.

Traffic volume: The number of vehicles passing per day over a given section of road. In general, the more traffic volume, the more road surfacing will be needed.

Turnout: A short auxiliary lane on a single-lane road which allows meeting vehicles to pass each other. It is usually designed for ease of access for the unloaded truck so that the loaded truck can proceed.

Undercut: An excavation from just below the subgrade surface. This may be an extension of the depth of cut in a cut area.

Vertical curve: A transition between two road grades, such as between uphill and downhill grades. A vertical curve is designed with flatter parabolic, or non-circular, curve, unlike a horizontal curve, which is designed as a portion of a whole circle.

Water bar: A structure installed in the road surface to divert road surface water off the road. Water bars are constructed from subgrade soil or other materials, such as rubber strips and timber.

Water body: A river, lake, stream, pond, wetland, or aquifer, or any part thereof, that is not located within the coastal marine area (RMA).

Water quality: The chemical, physical, biological and radiological characteristics of water. It is a measure of the condition of water relative to the requirements of one or more biotic species and/or any human need or purpose.

Water runoff control measures: Structures or measures to reduce the volume or velocity of water runoff, and consequently reduce its power to gather up and transport sediment.

Wearing surface (of a road): Refers to the surface on which vehicle wheels run.

Well-graded: Describes a soil composed of a variety of different particle sizes.

Yarding road: The path followed by a turn of logs yarded by a cable method.

U

V

W

Y

References

- A** **Arnold, G.** (1994). *Portable and Low Cost Bridges*. LIRO Report Vol. 19 No. 14.
- Arnold, G; Gaddum, G.** (1995). *Corduroy for Forest Roads*. Logging Industry Research Organisation Report, Volume 20, Number 4, 1995. Cited in nrs.fs.fed.us/epubs/gtr202/ncgtrpt2.pdf.
- ARRB Transport Research.** (2009). *Unsealed Roads Manual Guidelines to Good Practice*.
- Auckland Regional Council.** (2007). *Forestry Operations in the Auckland Region – A Guideline for Erosion and Sediment Control*. Technical Publication TP223. www.arc.govt.nz/albany/fms/main/Documents/Plans/Technical%20publications/201-250/ARC-TP-223%20B%20-%20Header%20&%20contents.pdf.
- Austrroads.** (2003). *A Guide to the Geometric Design of Rural Roads*. Association of Australian and New Zealand Road Traffic Authorities.
- Austrroads.** (1993). *Rural Road Design – A Guide to the Geometric Design of Rural Roads*. Publication No AP-G1/03.
- Austrroads.** *Geometric Design for Trucks – When, Where and How? AP R211/02*. www.onlinepublications.austrroads.com.au/items/AP-R211-02.
- Austrroads.** (1994). *Waterway Design – A Guide to the Hydraulic Design of Bridges, Culverts and Floodways*. Austrroads Publication No. AP-23/94.
- B** **Bay of Plenty Regional Council.** (2010). *Erosion and Sediment Control Guidelines for Land Disturbing Activities*. Bay of Plenty Regional Council, 2010/01. www.boprc.govt.nz/media/29555/Guideline-100624-ErosionandSedimentControl.pdf.
- Beable, M.E; McKerchar, A.I.** (1982). *Regional Flood Estimation in New Zealand*. Technical Report No 20, Water & Soil Division, Ministry of Work & Development (MWD).
- Brickell R.G.** (1985). *Geomechanics for New Zealand Roads*. R.RU.Technical Recommendation TR11. National Roads Board, Wellington.
- C** **Caterpillar Inc.** (2011). *Caterpillar Performance Handbook* (41st edition). Caterpillar Inc., Peoria, Illinois, USA.
- Concrete Pipe Association of Australia.** (1986). *Hydraulics of Precast Concrete Conduits: Hydraulic Design Manual*. 79 pp. www.cpa.asn.au/design-manuals.html.
- D** **Donahue, J.** (1987). *Hydraulic Design of Culverts on Forest Roads*. Canadian Journal of Forest Research, 1987, 17:(12) 1545-1551.
- Environment Bay of Plenty.** (2012). *Hydrological and Hydraulic Guidelines*. Bay of Plenty Regional Council. 74 pp. www.boprc.govt.nz/media/373948/hydrological-and-hydraulic-guidelines.pdf.
- Fairbrother, S; Visser, R; McGregor, R.** (2009). *Forest Road Pavement Design in New Zealand*. Kings Beach, CA, USA: 32nd Annual Meeting of the Council on Forest Engineering (COFE 09), 15-18 Jun 2009. 8 pp. <http://ir.canterbury.ac.nz/handle/10092/2621> vt.edu/cofe/documents/COFE_2009_Fairbrother_et_al.pdf.
- FP Innovations.** (2011). *Field Guide for Inspecting Bridges*. FP Innovations Road Engineering Group, Ontario Pointe- Claire, Quebec, Canada for the Ontario Ministry of Northern Development, Mines and Forestry. 40 pp. fpinnovations.ca.
- Ferry, A.** (1986). *Unsealed Roads – A Manual of Repair and Maintenance for Pavements*. RRD. Technical Recommendation TR18. Road Research Unit National Roads Board. Wellington.
- Franklin, P; Gee, E; Baker, C; Bowie, S. (DOC).** (2018). *New Zealand Fish Passage Guidelines for Structures up to 4 Metres*. Retrieved from www.niwa.co.nz/freshwater-and-estuaries/research-projects/new-zealand-fish-passage-guidelines on 24/05/18.
- Future Forest Research.** (2010). *Landing Size and Characteristics*. Harvesting Technical Note, Volume 3, number 5.
- Giummarra, G. (Ed.).** (2009). *Unsealed Roads Manual: Guidelines to Good Practice*. ARRB Transport Research Ltd: Victoria, Australia. www.arrb.com.au/admin/file/content13/c6/LocalRoadsNews69.pdf.
- Henderson, R; Collins, D; Doyle, M; Watson, J.** (2018). *Regional Flood Estimation Tool for NZ*. Abstract, NZ Hydro Soc conf Christchurch 2 pp.
- Henderson, R; Collins, D; Doyle, M; Watson, J.** (2018). *Regional Flood Estimation Tool for NZ*. Part 2. Prepared for Envirolink. NIWA client report 2018177CH. 48 pp.
- Hicks, D. and Anthony, T. (eds),** (2001). *NZ Soil Conservation Technical Handbook*. NZ Association for Resource Management. www.mfe.govt.nz/publications/land/soil-conservation-handbook-jun01/soil-conserv-handbook-jun01.pdf.
- Kemp, P.** (1984). *Battery Culvert Crossings for Logging Roads*. LIRA Technical Release Volume 6, Number 10.



Keller, G. and Sherar, J. (2003). *Low-Volume Roads Engineering: Best Management Practices Field Guide*. US Department of Agriculture, Forest Service, International Programs. Frost Areas. Transportation Research Record. 1819: 275-284. www.zietlow.com/manual/gk1/chapter4.pdf.

L **Lynn, I; Manderson, M; Page, M; Harmsworth, G; Eyles, G; Douglas, G; MacKay, A. and Newsome, P.** (2009). *Land Use Capability Survey Handbook – A New Zealand Handbook for the Classification of Land*. 3rd ed. Hamilton, AgResearch; Lincoln, Landcare Research; Lower Hutt, GNS Science. 163 pp. www.landcareresearch.co.nz/research/soil/luc/luc_handbook.pdf.

M **Mathur, T. S. and Coghlan, G.T.** (1987). *The Use of the Clegg Impact Tester in Managing and Designing Aggregate-surfaced Roads*. Transportation Research Board, 4th Int. Conf. on Low-Volume Roads, 1, Washington, D.C., 232–236 pp.

Ministry of Work & Development (MWD). (1980). *A Method for Estimating Design Peak Discharge*. Technical Memorandum No 6, Planning & Technical Services, Water & Soil Division. http://docs.niwa.co.nz/library/TM61_1980.pdf.

N **New Zealand Forest Owners Association.** (2018). *Forest Practice Guides*. <https://docs.nzfoa.org.nz/forest-practice-guides/>.

NZ Geotechnical Society. (2005). *Field Description of Soil and Rock – A Guideline for the Field Classification and Description of Soil and Rock for Engineering Purposes*. 38 pp. www.nzgs.org/wp-content/uploads/soil_and_rock_field_guide.pdf.

NZ Standards. NZS 4402.4.1. (1986). *Methods of testing soils for civil engineering purposes – Part 4 Soil Compaction tests*.

NZTA. (2018). *Best Practice Guides for Pavement Stabilisation*. <https://www.nzta.govt.nz/assets/resources/research/reports/622/622bestpracticeguideforpavementstabilisation.pdf>.

NZ Transport Agency. (2003). *Bridge Manual*. Version 2. www.nzta.govt.nz/resources/bridge-manual/index.html.

NZ Transport Agency. *Standard Specification F/1 – Earthworks Construction*. www.nzta.govt.nz/assets/resources/earthworks-const/docs/earthworks-const.pdf.

P **PennState.** (2007). *Environmentally Sensitive Maintenance for Dirt and Gravel Roads*. Report number USEPA-PA-2005.

Pidwerbesky, B. (1997). *Evaluation of Non-destructive In Situ Tests for Unbound Granular Pavements*. IPENZ Transactions, Vol. 24, No.1.

PSU. (2006). *Driving Surface Aggregate Specification*. Centre for Dirt and Gravel Roads. www.dirtandgravel.psu.edu.

Ryan, T; Phillips, H; Ramsay, J. and Dempsey, J. (2004). *Forest Road Manual: Guidelines for the Design, Construction and Management of Forest Road*. COFORD, National Council for Forest Research and Development: Dublin, Ireland.

Sissons, J. (2007). *Forest Road Operations in the Tropics*.

Transit NZ. (2007). *New Zealand Supplement to the Document: Pavement Design – A Guide to the Structural Design of Road Pavements*. (Austroads, 2004). www.austroads.com.au/pavement/index.html.

Transit NZ. (2006a). *M/04 Basecourse Aggregate*. www.nzta.govt.nz/resources/basecourse-aggregate/

Transit NZ. (2006b). *HM/23 Unsealed Pavements*. TNZ Somac 2006. S Highway Operations and Maintenance. www.nzta.govt.nz/resources/results.html?order=2&catid=39

US Federal Highway Administration. *Debris Control Structures: Evaluation and Countermeasures*. www.fhwa.dot.gov/engineering/hydraulics/pubs/04016/hec09.pdf.

Visser, R. (2010). *Landing Size and Characteristics*. Technical Note Vol 3, No. 5. Future Forests Research (FFR), Rotorua, New Zealand. <http://ir.canterbury.ac.nz/handle/10092/4482>

Waikato Regional Council. (2006). *Best Practice Guidelines for Waterway Crossings*. www.waikatoregion.govt.nz/PageFiles/4998/TR0625R.pdf.

Van Dine, D. F. (1996). *Debris Flow Control Structures for Forest Engineering*. British Columbia Ministry of Forests www.for.gov.bc.ca/hfd/pubs/docs/wp/wp22.htm

Walbridge, T. A. (1997). *The Location of Forest Roads*. Virginia Polytechnical Institute and State University, Blacksburg, V. A: Industrial Forest Operations. 91 pp. A Primer on Basic Road Planning, Reconnaissance, Location and Drainage in Mountain Terrain.

Websites, resources, databases - page 208

Websites, resources, databases

New Zealand

Environment Guide: <http://www.environmentguide.org.nz/activities/forestry/>

Forest Growers Research: <https://fgr.nz/>

Forest Practice Guides (FOA): docs.nzfoa.org.nz/forest-practice-guides/

Land Information NZ (LINZ) Elevation Data: <https://www.linz.govt.nz/data/linz-data/elevation-data>

NES-PF (Te Uru Rākau): <https://www.mpi.govt.nz/growing-and-harvesting/forestry/national-environmental-standards-for-plantation-forestry/>

New Zealand Archaeological Association: <http://archsite.org.nz/>

NZTA (2018) Best Practice Guides for Pavement Stabilisation: <https://www.nzta.govt.nz/assets/resources/research/reports/622/622-best-practice-guide-for-pavement-stabilisation.pdf>

Te Uru Rākau: <https://www.teururakau.govt.nz/te-uru-rakau-forestry-new-zealand/>

WorkSafe: <https://worksafe.govt.nz/>

International

Australian Road Research Board: www.arrb.com.au

Austroroads: www.austroroads.com.au

US Forest Service: www.fs.fed.us

Databases

NIWA Flood Frequency Tool: <https://niwa.co.nz/natural-hazards/hazards/floods>.

Te Uru Rākau – Erosion Susceptibility Classification: <https://www.teururakau.govt.nz/growing-and-harvesting/forestry/national-environmental-standards-for-plantation-forestry/erosion-susceptibility-classification/>

Te Uru Rākau – Fish Spawning Indicator: <https://www.teururakau.govt.nz/growing-and-harvesting/forestry/national-environmental-standards-for-plantation-forestry/fish-spawning-indicator>





supported by
forestgrowers
commodity levy



 **FOREST OWNERS ASSOCIATION**